

**GARMIN**

**G3X™ Touch Pilot's Guide**





**SYSTEM OVERVIEW**

**FLIGHT INSTRUMENTS**

**EIS**

**CNS INTERFACE**

**GPS NAVIGATION**

**FLIGHT PLANNING**

**HAZARD AVOIDANCE**

**ADDITIONAL FEATURES**

**AFCS**

**ANNUNCIATIONS & ALERTS**

**APPENDIX**

**INDEX**





© 2016 Garmin Ltd. or its subsidiaries. All rights reserved.

This manual reflects the operation of System Software version 5.00 or later. Some differences in operation may be observed when comparing the information in this manual to earlier or later software versions.

Garmin International, Inc., 1200 East 151st Street, Olathe, Kansas 66062, U.S.A.

Tel: 913/397.8200

Fax: 913/397.8282

Aircraft On Ground (AOG) Hotline: 913.397.0836

Aviation Dealer Technical Support: 888.606.5482

Garmin AT, Inc., 2345 Turner Road SE, Salem, OR 97302, U.S.A.

Tel: 503.581.8101

Fax 503.364.2138

Garmin (Europe) Ltd, Liberty House, Hounsdown Business Park, Southampton, Hampshire SO40 9LR, U.K.

Tel: +44/ (0) 238 052 4000

Fax: +44 (0) 238 052 4004

Aviation Support: +44 (0) 370 850 1243

Garmin Corporation, No. 68, Jangshu 2nd Road, Shijr, Taipei County, Taiwan

Tel: 886/02.2642.9199

Fax: 886/02.2642.9099

Web Site Address: [www.garmin.com](http://www.garmin.com)

Except as expressly provided herein, no part of this manual may be reproduced, copied, transmitted, disseminated, downloaded or stored in any storage medium, for any purpose without the express written permission of Garmin. Garmin hereby grants permission to download a single copy of this manual and of any revision to this manual onto a hard drive or other electronic storage medium to be viewed for personal use, provided that such electronic or printed copy of this manual or revision must contain the complete text of this copyright notice and provided further that any unauthorized commercial distribution of this manual or any revision hereto is strictly prohibited.

Garmin®, FliteCharts®, SafeTaxi®, and MapSource® are registered trademarks of Garmin Ltd. or its subsidiaries. ANT+™ and G3X Touch™ are trademarks of Garmin Ltd. or its subsidiaries. These trademarks may not be used without the express permission of Garmin.

Jeppesen® is a registered trademark of Jeppesen, Inc.

NavData™ is a trademark of Jeppesen, Inc.

SiriusXM Weather is provided by SiriusXM Satellite Radio, Inc.

SiriusXM Radio is provided by SiriusXM Satellite Radio, Inc.

The Bluetooth® word mark and logos are registered trademarks owned by Bluetooth SIG, Inc. and any use of such marks by Garmin is under license

This product is ANT+™ certified. Visit [www.thisisant.com/directory](http://www.thisisant.com/directory) for a list of compatible products and apps.

December, 2016

190-01754-00 Rev. H

Printed in the U.S.A.



---

**WARNING:** Navigation and terrain separation must NOT be predicated upon the use of the terrain function. The G3X Touch Terrain Proximity feature is NOT intended to be used as a primary reference for terrain avoidance and does not relieve the pilot from the responsibility of being aware of surroundings during flight. The Terrain Proximity feature is only to be used as an aid for terrain avoidance and is not certified for use in applications requiring a certified terrain awareness system. Terrain data is obtained from third party sources. Garmin is not able to independently verify the accuracy of the terrain data.

---



---

**WARNING:** To reduce the risk of unsafe operation, carefully review and understand all aspects of the G3X Touch Pilot's Guide documentation and the Pilot's Operating Handbook of the aircraft. Thoroughly practice basic operation prior to actual use. During flight operations, carefully compare indications from the G3X Touch to all available navigation sources, including the information from other NAVAIDs, visual sightings, charts, etc. For safety purposes, always resolve any discrepancies before continuing navigation.

---



---

**WARNING:** The displayed minimum safe altitudes (MSAs) are only advisory in nature and should not be relied upon as the sole source of obstacle and terrain avoidance information. Always refer to current aeronautical charts for appropriate minimum clearance altitudes.

---



---

**WARNING:** The altitude calculated by G3X Touch internal GPS receivers is geometric height above Mean Sea Level and could vary significantly from the altitude displayed by pressure altimeters. Always use pressure altitude displayed by the G3X Touch PFD when determining or selecting aircraft altitude.

---



---

**WARNING:** Do not use outdated database information. Databases used in the G3X Touch system must be updated regularly in order to ensure that the information remains current. Pilots using any outdated database do so entirely at their own risk.

---



---

**WARNING:** Do not use data link weather information for maneuvering in, near, or around areas of hazardous weather. Information contained with in data link weather products may not accurately depict current weather conditions.

---



---

**WARNING:** Do not use the indicated data link weather product age to determine the age of the weather information shown by the data link weather product. Due to time delays inherent in gathering and processing weather data for data link transmission, the weather information shown by the data link weather product may be significantly older than the indicated weather product age.

---



---

**WARNING:** The data contained in the terrain and obstacle databases comes from government agencies. Garmin accurately processes and cross-validates the data, but cannot guarantee the accuracy and completeness of the data.

---



---

**WARNING:** The illustrations in this guide are only examples. Never use the G3X Touch to attempt to penetrate a thunderstorm. Both the FAA Advisory Circular, Subject: Thunderstorms, and the Aeronautical Information Manual (AIM) recommend avoiding "by at least 20 miles any thunderstorm identified as severe or giving an intense radar echo."

---



---

**WARNING:** Because of variation in the earth's magnetic field, operating the G3X Touch within the following areas could result in loss of reliable attitude and heading indications. North of 72° North latitude at all longitudes; South of 70° South latitude at all longitudes; North of 65° North latitude between longitude 75° W and 120° W. (Northern Canada); North of 70° North latitude between longitude 70° W and 128° W. (Northern Canada); North of 70° North latitude between longitude 85° E and 114° E. (Northern Russia); South of 55° South latitude between longitude 120° E and 165° E. (Region south of Australia and New Zealand)

---



---

**WARNING:** *The United States government operates the Global Positioning System and is solely responsible for its accuracy and maintenance. The GPS system is subject to changes which could affect the accuracy and performance of all GPS equipment. Portions of the Garmin G3X Touch utilize GPS as a precision electronic NAVigation AID (NAVAID). Therefore, as with all NAVAIDs, information presented by the G3X Touch can be misused or misinterpreted and, therefore, become unsafe.*

---



---

**WARNING:** *Do not use basemap (land and water data) information for primary navigation. Basemap data is intended only to supplement other approved navigation data sources and should be considered as an aid to enhance situational awareness.*

---



---

**WARNING:** *Do not use the approach information provided by the VFR navigation database residing within the G3X Touch as a means of navigating any instrument approach. The G3X Touch VFR navigation database is limited to present only the waypoints for the final approach leg of a published procedure. These waypoints and associated course line are made available for monitoring purposes only.*

---



---

**WARNING:** *Do not rely solely upon the display of traffic information for collision avoidance maneuvering. The traffic display does not provide collision avoidance resolution advisories and does not under any circumstances or conditions relieve the pilot's responsibility to see and avoid other aircraft.*

---



---

**WARNING:** *Do not rely solely upon the display of traffic information to accurately depict all of the traffic within range of the aircraft. Due to lack of equipment, poor signal reception, and/or inaccurate information from aircraft or ground stations, traffic may be present that is not represented on the display.*

---



---

**WARNING:** *For safety reasons, G3X Touch operational procedures must be learned on the ground.*

---



---

**CAUTION:** The display uses a lens with a special coating that may be sensitive to abrasive cleaners, etc. **CLEANERS CONTAINING AMMONIA OR SOLVENTS MAY HARM THIS COATING.** It is very important to clean the lens using a clean, lint-free cloth (such as the Garmin cleaning cloth). Avoid any chemical cleaners or solvents that can damage plastic components.

---



---

**CAUTION:** The Garmin G3X Touch does not contain any user-serviceable parts. Repairs should only be made by an authorized Garmin service center. Unauthorized repairs or modifications could void both the warranty and the pilot's authority to operate this device under FAA/FCC regulations.

---



---

**NOTE:** The Garmin G3X Touch has a very high degree of functional integrity. However, the pilot must recognize that providing monitoring and/or self-test capability for all conceivable system failures is not practical. Although unlikely, it may be possible for erroneous operation to occur without a fault indication shown by the G3X Touch. It is thus the responsibility of the pilot to detect such an occurrence by means of cross-checking with all redundant or correlated information available in the cockpit.

---



---

**NOTE:** All visual depictions contained within this document, including screen images of the G3X Touch panel and displays, are subject to change and may not reflect the most current G3X Touch system and aviation databases. Depictions of equipment may differ slightly from the actual equipment.

---



---

**NOTE:** This product, its packaging, and its components contain chemicals known to the State of California to cause cancer, birth defects, or reproductive harm. This notice is being provided in accordance with California's Proposition 65. If you have any questions or would like additional information, please refer to our web site at [www.garmin.com/prop65](http://www.garmin.com/prop65).

---



---

**NOTE:** Interference from GPS repeaters operating inside nearby hangars can cause an intermittent loss of attitude and heading displays while the aircraft is on the ground. Moving the aircraft more than 100 yards away from the source of the interference should alleviate the condition.

---



---

**NOTE:** Use of polarized eyewear may cause the flight displays to appear dim or blank.

---



---

**NOTE:** Temporary Flight Restriction (TFR) data is provided by the FAA and may not be updated outside of normal business hours. Confirm data currency through alternate sources and contact your local FSS for interpretation of TFR data.

---



---

**NOTE:** The Garmin G3X Touch system includes products like the GDU 46X and the GSU 73 that are not TSO-certified products and have not received FAA approval or endorsement. Consequently the G3X Touch system is not suitable for installation in type-certificated aircraft.

---



---

**NOTE:** Unless otherwise specified, all screen images contained within this document are taken from the GDU 46X display. The GDU 45X screen images will vary slightly from the GDU 46X.

---



---

**NOTE:** The GDU 46X automatically logs flight data, including, but not limited to primary flight data, engine parameters and system status information. You can download this data to an SD card, when the aircraft is on the ground. The downloaded data can be viewed using common computer software. It is not possible to disable the logging of this data or to manually delete logged data. Logged data will be stored only on the GDU 46X and will not be transmitted or transferred to Garmin or to any other third party, with the exception of government agencies investigating an accident or incident involving your aircraft and/or the parties to any resulting legal proceedings that may be related to the aircraft accident or incident.

---



---

**NOTE:** The Bluetooth® word mark and logos are registered trademarks owned by Bluetooth SIG, Inc. and any use of such marks by Garmin is under license.

---

## 1. FCC

Contains FCC ID: QQQT321

### NOTE

This device complies with Part 15 of the FCC Rules. Operation is subject to the following two conditions: (1) this device may not cause harmful interference, and (2) this device must accept any interference received, including interference that may cause undesired operation.

FCC RF Radiation Exposure Statement:

This equipment complies with FCC radiation exposure limits set forth for an uncontrolled environment. End users must follow the specific operating instructions for satisfying RF exposure compliance. This transmitter meets both portable and mobile limits as demonstrated in the RF Exposure Analysis. This transmitter must not be co-located or operating in conjunction with any other antenna or transmitter except in accordance with FCC multi-transmitter product procedures.

## 2. IC

Contains IC: 5123A-BGTWT321

### NOTE

This device complies with Industry Canada license-exempt RSS standard(s). Operation is subject to the following two conditions: (1) this device may not cause interference, and (2) this device must accept any interference, including interference that may cause undesired operation of the device.

Cet appareil est conforme aux normes RSS sans licence d'Industrie Canada. Son fonctionnement est soumis aux conditions suivantes : (1) cet appareil ne doit pas causer d'interférences et (2) doit accepter toute interférence, y compris les interférences pouvant entraîner un fonctionnement indésirable de l'appareil.

### NOTE

Under Industry Canada regulations, this radio transmitter may only operate using an antenna of a type and maximum (or lesser) gain approved for the transmitter by Industry Canada. To reduce potential radio interference to other users, the antenna type and its gain should be so chosen that the equivalent isotropically radiated power (e.i.r.p.) is not more than that necessary for successful communication.

Selon les réglementations d'Industrie Canada, cet émetteur radio ne doit fonctionner qu'avec une antenne d'une typologie spécifique et d'un gain maximum (ou inférieur) approuvé pour l'émetteur par Industrie Canada. Pour réduire les éventuelles perturbations radioélectriques nuisibles à d'autres utilisateurs, le type d'antenne et son gain doivent être choisis de manière à ce que la puissance isotrope rayonnée équivalente (P.I.R.E.) n'excède pas les valeurs nécessaires pour obtenir une communication convenable.

Part Number	Change Summary
190-001754-00	Initial release

Rev	Date	Description
A	March, 2014	Production Release
B	December, 2014	Added GDU 45X, VIRB Video Input, Ant+, Connex.
C	December, 2014	Fixed tabs.
D	March, 2015	Added Electronic Stability Protection, Connex updates, Bluetooth Limitations, Carbon Monoxide Detector, Pulse Oximeter, Glide Range Ring, Best Airport Bearing Pointer.
E	May, 2015	Added Flight Director Configuration.
F	April, 2016	Added GMA 245/245R info, miscellaneous updates.
G	September, 2016	<p>Added G5 AHRS redundancy</p> <p>Added new Data Bar fields</p> <p>Create Waypoints from current position using Info page</p> <p>Added on-screen volume controls for COM radios, intercom, Bluetooth audio, and music input</p> <p>Round Gauges available for PFD instruments</p> <p>Bluetooth on GMA 245R rackmount radios can be disabled remotely</p> <p>Added Best Airport Line</p> <p>Added Target Trend on Moving Map</p> <p>Revised description of ESP arming altitudes and use of AFCS Level mode</p>
H	December, 2016	<p>Added enhanced engine monitoring capabilities</p> <p>Added airspace altitude overlays</p> <p>Updated Appendix A. Changed DST data field to DIST</p> <p>Updated Appendix A. Added DISTD data field.</p>



<b>Section 1 System Overview</b> .....	1
<b>1.1 Line Replaceable Units</b> .....	1
G3X Touch System .....	8
External Navigators (Optional) .....	9
Automatic Flight Control System (Optional) .....	11
<b>1.2 Display Overview</b> .....	12
<b>1.3 Secure Digital (SD) Cards</b> .....	14
<b>1.4 System Power-up</b> .....	14
<b>1.5 System Operation</b> .....	16
Split Mode .....	16
PFD/MFD Display Configuration .....	17
G3X Touch System Annunciations .....	21
AHRS Operation .....	21
<b>1.6 Accessing System Functionality</b> .....	23
Menus .....	23
Data Entry .....	23
Pages .....	24
<b>1.7 Accessing Additional Information</b> .....	27
Viewing GPS Receiver Status .....	27
Position .....	29
<b>1.8 System Settings</b> .....	30
Transponder .....	30
Data Bar Setup .....	31
Display .....	33
Display setup page .....	34
Sound .....	37
Units .....	38
Time .....	38
Position .....	39
Alarms .....	39
Airport Criteria .....	40
<b>Section 2 Flight Instruments</b> .....	43
<b>2.1 Flight Instruments</b> .....	43
Airspeed Indicator .....	45
Attitude Indicator .....	48
Altimeter .....	50
Vertical Speed Indicator (VSI) .....	54
Vertical Deviation Indicator and VNAV Indicator .....	55
Horizontal Situation Indicator (HSI) .....	57
Trim and Flap Position Indicators (optional) .....	66
Turn Rate Indicator .....	66
OBS Mode .....	67

<b>2.2 Supplemental Flight Data</b> .....	69
Outside Air Temperature .....	69
Wind Data .....	70
User Timer .....	70
Angle of Attack (AOA) .....	71
<b>2.3 Vertical Navigation (VNAV)</b> .....	73
Using the VNAV Feature .....	74
<b>Section 3 Engine Indication System</b> .....	77
<b>3.1 EIS Display &amp; ENG Page</b> .....	77
<b>3.2 Multi-Engine Indications (Optional)</b> .....	80
Propeller Sync Indicator .....	80
<b>3.3 Lean Assist Mode (Optional)</b> .....	81
<b>3.4 Fuel Calculator (Optional)</b> .....	86
<b>3.5 CAS Messages (Optional)</b> .....	87
<b>Section 4 CNS Interface</b> .....	89
<b>4.1 CNS interface</b> .....	89
<b>4.2 Auto-tuning Frequencies (Optional)</b> .....	90
<b>4.3 COM Radio (Optional)</b> .....	92
Automatic Squelch .....	94
<b>4.4 GMA 245/245R (Optional)</b> .....	95
Audio/Intercom Page .....	97
Radios Tab .....	97
Intercom Tab .....	100
Phone & Media Tab .....	103
Music Input Tab .....	112
<b>4.5 Remote Transponder Interface (Optional)</b> .....	114
Transponder CODE and Mode Selection .....	116
ADS-B Out .....	118
Flight ID Reporting .....	118
<b>Section 5 GPS Navigation</b> .....	119
<b>5.1 Introduction</b> .....	119
Compass Arc .....	119
<b>5.2 Using Map Displays</b> .....	120
Map Page Setup .....	121
Map Range .....	123
Map Panning .....	124
Fuel Range Ring .....	126
Glide Range Ring .....	127
Best Airport Bearing Pointer .....	129
Best Airport Line .....	131

Selected Altitude Intercept Arc .....	131
Measuring Bearing and Distance .....	132
Topography .....	132
Map Page Traffic .....	133
Map Symbols .....	133
<b>5.3 Airways .....</b>	<b>134</b>
<b>5.4 Waypoints .....</b>	<b>136</b>
Nearest Information .....	139
Weather Information .....	140
Intersections .....	140
NDBs .....	141
VORs .....	141
User Waypoints .....	142
Automatic Waypoint Selection .....	144
<b>5.5 Airspace .....</b>	<b>144</b>
Airspace Alert Messages .....	145
Smart Airspace™ With Altitude Overlays .....	145
<b>5.6 Direct-to Navigation Using the G3X Touch .....</b>	<b>146</b>
<b>Section 6 Flight Planning .....</b>	<b>151</b>
<b>6.1 Introduction .....</b>	<b>151</b>
Flight Plan Data Fields .....	152
Manually Switching Between Internal and External Flight Plan Sources .....	152
Failure of the External GPS Navigation Source .....	152
<b>6.2 Flight Plan Creation Using the G3X Touch .....</b>	<b>153</b>
<b>6.3 Flight Plan Storage Using the G3X Touch .....</b>	<b>155</b>
<b>6.4 Flight Plan Activation Using the G3X Touch .....</b>	<b>156</b>
<b>6.5 Flight Plan Editing .....</b>	<b>157</b>
Adding Waypoints to an Existing Flight Plan .....	157
Editing Flight Plan Speed, Fuel, and/or Name .....	158
Copying Flight Plans .....	159
Deleting Flight Plans .....	160
Inverting a Flight Plan .....	161
Importing/Exporting Flight Plans .....	161
<b>6.6 Approaches (Without External Navigator Configured) .....</b>	<b>162</b>
Selecting an Approach .....	163
Activating Vectors-to-Final .....	165
<b>Section 7 Hazard Avoidance .....</b>	<b>167</b>
<b>7.1 Weather Information .....</b>	<b>167</b>
Weather Source .....	167
Data Link Weather (Optional) .....	168

<b>7.2 Terrain</b> .....	186
Synthetic Vision.....	187
Terrain Information.....	188
Terrain Views.....	188
Terrain Settings.....	190
Terrain Alerts.....	191
<b>7.3 Traffic Systems</b> .....	193
Traffic Information Service (TIS-A) (Optional).....	195
Garmin GTS 800 Traffic (Optional).....	200
Data Link Traffic (GDL 39/39R) (Optional).....	208
<b>Section 8 Additional Features</b> .....	221
<b>8.1 Synthetic Vision (SVX)</b> .....	222
Synthetic Vision Operation.....	224
<b>8.2 SafeTaxi®</b> .....	235
SafeTaxi Cycle Number and Revision.....	236
<b>8.3 ChartView</b> .....	236
Aircraft Symbol.....	238
Chart Range.....	238
Navigation Database-published NOTAMS.....	239
<b>8.4 FliteCharts®</b> .....	239
Aircraft Symbol.....	242
Chart Range.....	242
FliteCharts Cycle Number and Expiration Date.....	242
<b>8.5 Airport Directory Data</b> .....	243
<b>8.6 SIRIUSXM Radio Entertainment (Optional)</b> .....	245
Activating SiriusXM Satellite Radio Services.....	245
Using SIRIUSXM Radio.....	245
<b>8.7 Vertical Power (Optional)</b> .....	247
<b>8.8 Electronic Checklists (Optional)</b> .....	249
<b>8.9 Flight Data Logging</b> .....	249
<b>8.10 VIRB Video Input</b> .....	250
<b>8.11 Connex Cockpit Connectivity</b> .....	256
<b>8.12 Electronic Stability &amp; Protection (ESP-X)</b> .....	262
Roll Engagement.....	264
Pitch Engagement.....	265
Airspeed Protection.....	267
<b>8.13 Carbon Monoxide (CO) Detector (Optional)</b> .....	267
<b>8.14 Pulse Oximeter (Optional)</b> .....	268
<b>Section 9 Automatic Flight Control Systems (Optional)</b> .....	269
AFCS System Architecture.....	269

G3X Touch AFCS Installations Options .....	271
Control Wheel Steering (CWS) (Optional) .....	272
G3X Touch AFCS Status Box .....	272
<b>9.1 AFCS Operation</b> .....	274
AFCS PRE-FLIGHT Actions .....	276
AFCS Controls .....	277
Flight Director Operation .....	285
<b>9.2 Vertical Modes</b> .....	293
Pitch Hold Mode (PIT) .....	295
Selected Altitude Capture Mode (ALTS) .....	296
Vertical Speed Mode (VS) .....	298
Indicated Airspeed Mode (IAS) .....	299
Vertical Navigation Mode (VNAV) .....	300
VNAV Target Altitude Capture Mode (ALTV) .....	302
Glidepath Mode (GP) (with external WAAS enabled IFR navigator ONLY) .....	303
Glide slope Mode (GS) .....	305
Go Around (GA) and Takeoff (TO) Modes .....	306
<b>9.3 Lateral Modes</b> .....	307
Roll Hold Mode (ROL) .....	308
Heading Select Mode (HDG) .....	309
Navigation Modes (GPS, VOR, LOC, BC) .....	310
Approaches without Vertical Guidance .....	315
Approaches with Lateral + Vertical Guidance .....	318
<b>Section 10 Annunciations &amp; Alerts</b> .....	323
<b>10.1 Miscellaneous Message Advisories</b> .....	323
<b>10.2 System Status Messages</b> .....	325
System Status Messages .....	326
<b>10.3 Audio Alerts</b> .....	330
Voice Alerts .....	330
AOA Aural Alert .....	330
<b>10.4 PFD Annunciations and Alerting Functions</b> .....	331
CAS Messages (Optional) .....	331
Terrain Annunciations .....	331
Traffic Annunciations .....	331
AHRS Alerts (Optional) .....	332
AFCS Alerts (Optional) .....	333
Vertical Power Fault Indications .....	334
<b>Section 11 Appendices</b> .....	335
<b>Appendix A: Data Field Options</b> .....	335
<b>Appendix B: Utilities</b> .....	343
Flight Log .....	343
Track log .....	346

Track Vector .....	350
Weight & Balance .....	352
Proximity Waypoints .....	354
<b>Appendix C: SD Card Use and Databases .....</b>	<b>357</b>
Installing and Removing SD Cards .....	357
G3X Touch Databases .....	359
Updating G3X Touch Databases .....	362
Importing/Exporting Flight Plans To/From the SD Card .....	366
Flight Data Logging .....	366
<b>Appendix D: Map Datum and Location Formats .....</b>	<b>367</b>
Map Datums .....	367
Location Formats .....	367
<b>Appendix E: General TIS-A Information .....</b>	<b>369</b>
TIS-A vs. TAS/TCAS .....	369
TIS-A Limitations .....	370
<b>Appendix F: Abnormal Operation .....</b>	<b>373</b>
Loss of GPS Position .....	373
Hazard Display with Loss of GPS Position .....	373
G3X Touch System Failure Annunciations .....	374
Unusual Attitudes .....	374
Reversionary Mode (Full-Screen) .....	375
AFCS Reversionary Mode .....	375
Failure of the External GPS Navigation Source .....	376
Synthetic Vision Troubleshooting .....	376
<b>Appendix G: Display Symbols .....</b>	<b>377</b>
VFR Symbols .....	377
IFR Symbols .....	378
Airspace Symbols .....	380
<b>Appendix H: Glossary .....</b>	<b>383</b>
<b>Appendix I: License Agreement and Warranty .....</b>	<b>389</b>
Contact Garmin .....	389
Software License Agreement .....	389
Limited Warranty for G3X Touch Products .....	389
AOPA Airport Directory Notice .....	390
AC-U-KWIK LICENSE AGREEMENT .....	391
SiriusXM Satellite Radio Service Agreement .....	391
Weather Data Warranty .....	391
<b>Index .....</b>	<b>Index-1</b>

## SECTION 1 SYSTEM OVERVIEW

### 1.1 LINE REPLACEABLE UNITS

The G3X Touch system may consist of the following Line Replaceable Units (LRUs):

- **Garmin Display Unit (GDU) 460 or 465 (with SiriusXM)**
  - Single Display: Split Primary Flight Display (PFD) & Multi Function Display (MFD)
  - Multiple Displays: PFD, MFD, or split-screen



GDU 46X (10.6 inch)

- **GDU 450 or 455 (with SiriusXM)**

- Single Display: Split Primary Flight Display (PFD) & Multi Function Display (MFD)
- Multiple Displays: MFD, PFD, or split-screen



**GDU 45X (7 inch)**

- System Overview
- Flight Instruments
- EIS
- CNS Interface
- GPS Navigation
- Flight Planning
- Hazard Avoidance
- Additional Features
- AFCS
- Annun/Alerts
- Appendix
- Index



### • GSU 73

- Garmin Sensor Unit sub-system for the G3X Touch (Air Data Computer (ADC), Engine/Airframe Unit, and the Attitude and Heading Reference System (AHRS))
  - ADC: Processes data from the pitot-static system and outside air temperature (OAT) sensor.
  - Engine/Airframe Unit: Receives and processes signals from the engine and airframe sensors.
  - AHRS: Provides aircraft attitude and heading information to the PFD. The AHRS contains advanced sensors (including accelerometers and rate sensors) and interfaces with the Magnetometer to obtain magnetic field information, with the ADC to obtain air data, and with the GDU to obtain GPS information. AHRS operation is discussed later in this section.
  - ARINC 429 interface: Transmits and receives ARINC 429 signals for interface to panel-mount IFR GPS navigators.



GSU 73

- **GSU 25**

- Garmin Sensor Unit sub-system for the G3X Touch (Air Data Computer (ADC), and the Attitude and Heading Reference System (AHRS))
  - ADC: Processes data from the pitot-static system and outside air temperature (OAT) sensor.
  - AHRS: Provides aircraft attitude and heading information to the PFD. The AHRS contains advanced sensors (including accelerometers and rate sensors) and interfaces with the Magnetometer to obtain magnetic field information, with the ADC to obtain air data, and with the GDU to obtain GPS information. AHRS operation is discussed later in this section.



GSU 25

- **GMU 44/GMU 22**

- Magnetometer: Measures the local magnetic field and sends data to the AHRS for processing to determine aircraft magnetic heading. This unit receives power directly from the AHRS and communicates with it via an RS-485 digital interface.



**GMU 44/GMU 22**

- **GTP 59**

- Temperature Probe: Provides raw air temperature data.



**GTP 59**

- **GAP 26**

- Pitot/AOA Probe: Sends dynamic air pressure for airspeed and angle of attack (AOA), when paired with a GSU 25.

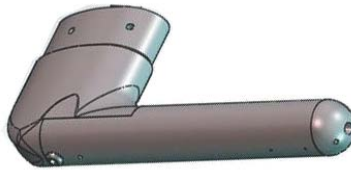

**GAP 26**

- **GSA 28**

- Auto Pilot Servo: Used for automatic control of pitch, roll, and yaw.



**GSA 28**

- **GEA 24**

- Engine and Airframe Unit: Receives and processes signals from the engine and airframe sensors.



GEA 24

- **GAD 29**

- ARINC 429 interface: Transmits and receives ARINC 429 signals for interface to panel-mount IFR GPS navigators.



## G3X TOUCH SYSTEM

The G3X Touch System can be configured with one, two, three, or four displays (GDU 46X shown below, four display system not shown) .



**GDU 46X Single Display System**



**GDU 46X Double Display System**



**GDU 46X Triple Display System**

- System Overview
- Flight Instruments
- EIS
- CNS Interface
- GPS Navigation
- Flight Planning
- Hazard Avoidance
- Additional Features
- AFCS
- Annun/Alerts
- Appendix
- Index

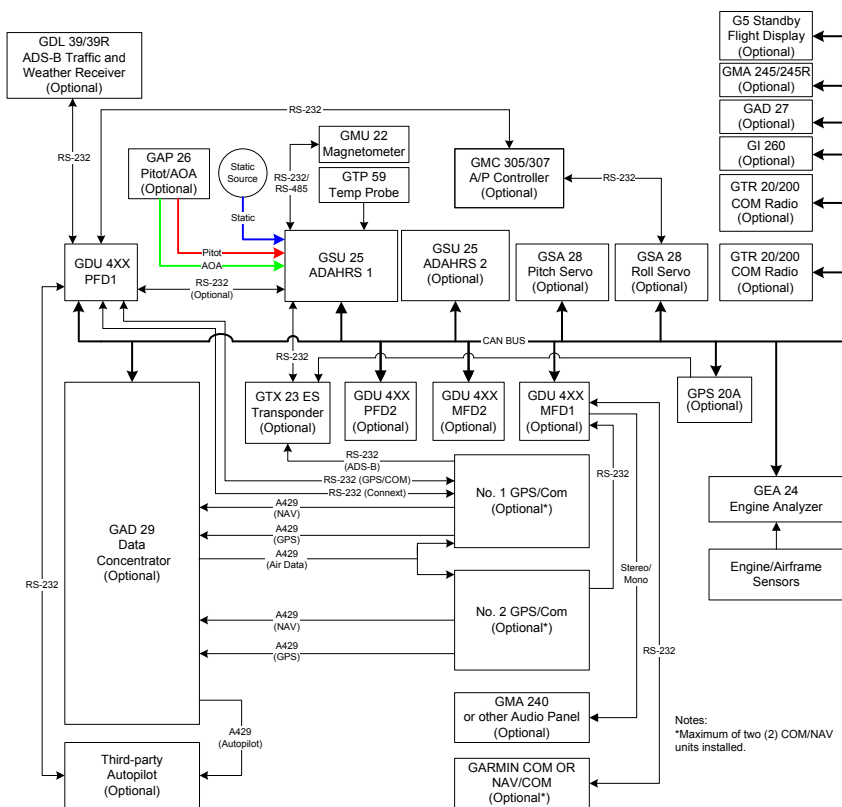

### G3X Touch System

## EXTERNAL NAVIGATORS (OPTIONAL)

The G3X Touch can also communicate with the following optional external navigators:

- SL30 Nav/Comm Transceiver
- SL40 Comm Transceiver
- GTR series Comm Transceiver
- GNC series Nav/Comm Transceiver
- GTN or GNS Series Units

## USING THE G3X TOUCH WITH AN EXTERNAL GPS NAVIGATOR



**WARNING:** Do not use the approach information provided by the VFR navigation database residing within the G3X Touch as a means of navigating any instrument approach. The G3X Touch VFR navigation database is limited to present only the waypoints for the final approach leg of a published procedure. These waypoints and associated course line are made available for monitoring purposes only.

In a configuration which includes one or more external GPS navigators (i.e., GTN or GNS Series), the G3X Touch displays the selected external GPS Navigator's flight plan and guidance information. When using an external GPS navigator with the G3X Touch, touch **FPL Source > Internal** on the Flight Plan Page to make changes to the active flight plan from the G3X Touch. Touch **FPL Source > External** to return to the external GPS navigator's flight plan. When an external navigator is configured the internal GPS can still be used for VFR navigation.



**NOTE:** The G3X Touch internal GPS flight plan is only for VFR use.

## CHANGING THE NAVIGATION SOURCE

When an external navigator that supports both GPS and VOR/ILS capabilities (i.e., GTN or GNS Series) is selected, the external navigator's **CDI** Key is used to switch the G3X Touch HSI between GPS and VOR/ILS navigation.



## SELECTION BETWEEN MULTIPLE NAVIGATORS

The G3X Touch **CDI Source** button in the PFD Options Window becomes available when more than one source of navigation data is configured. The **CDI Source** button toggles between the available navigation sources (e.g., between the internal G3X Touch GPS and external SL30 VLOC sources, between an SL30 and a GNS 430, or between two GNS 430s, etc). Refer to the Flight Instruments section for more information.

## USING MAPMX SERIAL DATA INPUT FORMAT

When using a WAAS enabled external GPS navigator (i.e., GNS 430W/530W, GNS 480 or any GTN Series navigator), and configuring an RS-232 input for 'MapMX' instead of 'Aviation In', a more accurate depiction of the flight plan legs are displayed on the moving map (i.e., holds, procedure turns, etc). Non-WAAS external navigators do not support MapMX. Refer to the G3X Touch Installation Manual for more information.

## EXTERNAL GPS NAVIGATOR FAILURE

In the event that all configured external GPS navigators fail, the G3X Touch reverts to its internal VFR GPS for navigation and flight plan modifications.

## AUTOMATIC FLIGHT CONTROL SYSTEM (OPTIONAL)

The G3X Touch can also communicate with Garmin GSA 28, Garmin GMC 305/307 and various third-party autopilot units. With the AFCS configured, the G3X Touch issues pitch and roll steering commands to the autopilot unit. Refer to Section 9 (AFCS) for more information.

## 1.2 DISPLAY OVERVIEW



Bezel Overview (GDU 46X)



- NRST Key** Press to display the Nearest Page for viewing the nearest airports, intersections, NDBs, VORs, waypoints, frequencies, and airspaces
- Direct-To Key** Press to activate the Direct-To function, enter a destination waypoint and establish a direct course to the selected destination
- MENU Key** Press once to view the Page Menu  
Press twice to view the Main Menu  
Press a third time to clear the Main Menu
- BACK Key** Press to return to the previous screen.

## 1.3 SECURE DIGITAL (SD) CARDS



**NOTE:** Refer to Appendix C for more information on SD Card use and databases.

The G3X Touch data card slot uses Secure Digital (SD) cards. The SD card can be used for software updates, checklist files, flight data logging, exporting Track Logs/User Waypoints, and Importing/Exporting Flight Plans.

### Installing an SD Card:

- 1) Insert the SD card in the SD card slot with the card contacts facing down (the card should be flush with the face of the bezel).
- 2) To eject the card, gently press on the SD card to release the spring latch.

## 1.4 SYSTEM POWER-UP

During system initialization, the AHRS displays the message 'AHRS ALIGN, KEEP WINGS LEVEL' over the attitude indicator. The AHRS should display valid attitude and heading fields typically within the first minute of power-up. The AHRS can align itself both while taxiing and during level flight.

The data link weather advisory and current database information are displayed during power-up including valid operating dates, cycle number, and database type. When this information has been reviewed for currency (to ensure that no databases have expired), the pilot is prompted to continue.

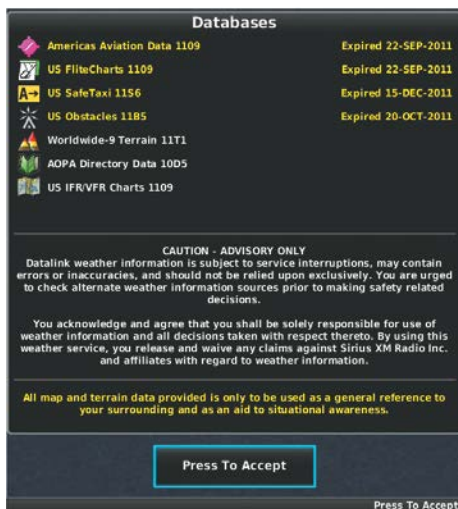

### Database Information

Touch **Press To Accept** to acknowledge the information.

# 1.5 SYSTEM OPERATION



**NOTE:** Refer to the G3X Touch Installation Manual for information on configuring the displays).

## SPLIT MODE

Press **Split** or **Full** in the upper left or right hand corner of the display to toggle between split and full screen.

Touch To Swap MFD With PFD

Touch To Access The Engine Page



Split Mode - GDU 45X

Touch To Access The Engine Page



Split Mode - GDU 46X

## PFD/MFD DISPLAY CONFIGURATION

### Changing the PFD/MFD Startup Page (GDU 46X, GDU 45X MFD):

- 1) Press the **MENU** Key twice to display the Main Menu.
- 2) Touch **Setup > Display**.
- 3) In the PFD/MFD Startup Page field, touch 'Auto' (selecting Auto allows selection of info to be displayed) or 'Split'.

### Changing the PFD/MFD Split-Screen Side (GDU 46X only):

- 1) Press the **MENU** Key twice to display the Main Menu.
- 2) Touch **Setup > Display**.
- 3) In the PFD/MFD Split Screen Side field, touch 'Left' or 'Right'.

## PFD OPTIONS

Pressing the **MENU** Key while the PFD is in Full screen mode shows options for several navigation tools. While the PFD Options menu is open, pressing the **MENU** Key again will open the Main Menu. The PFD Options menu also has a **More Options...** button to enter PFD Setup to customize the PFD itself.

## INSET WINDOWS

Each Inset Window can be configured to display one of a variety of information alongside the PFD. Inset Windows are available on GDU 460 and GDU 465 display units.

<b>Map</b>	Touch the magnification buttons to zoom in or out of the map. Touch anywhere else to show the split-screen map.
<b>Traffic</b>	Touch the magnification buttons to zoom in or out of the map. Touch anywhere else to show the split-screen traffic display.
<b>Flight Plan</b>	Touch and drag to scroll through the flight plan. Touch to show the split-screen flight plan display.
<b>Video Input</b>	Touch to show the split-screen video display.
<b>G Meter</b>	Touch to reset the G Meter to zero.

## BEARING POINTERS

Two Bearing Pointers for the HSI can be enabled or disabled in the PFD Options menu. Touch  to set each Bearing Pointer to **Off**, **GPS**, or **Nearest Airport**. Each Bearing Pointer is accompanied by an info box below the HSI indicating its target.

While the G3X Touch has an active flight plan, setting a Bearing Pointer to **GPS** will indicate the heading of the next waypoint on the active flight plan. Without an active flight plan, setting a Bearing Pointer to **GPS** will not display a Bearing Pointer.

## TIMER

A simple timer for measuring arbitrary periods of time, separately from the Flight Timer. Tap **Start** to start the Timer. While the Timer is running, the Start button becomes a **Stop** button which pauses the Timer. **Reset** will set the Timer to zero and stop the Timer. The Timer is visible at the left-center of the status bar at the bottom of the screen, labeled as 'TMR'. Pressing the **Back** Key to close the PFD Options menu will not interrupt the Timer.

## MINIMUMS

The Minimums option sets a minimum barometric altitude. If the G4X Touch detects the aircraft descending to this altitude and isn't on approach, the Minimums Alert will sound.

## PFD KNOB CUSTOMIZATION

The display unit knobs are highly customizable and can be configured for a variety of functions, especially for PFD functions. The two options that configure the PFD knobs are found in the PFD Setup menu. On the PFD display unit, press the **MENU** button and touch the **More Options...** on-screen button.

The "main" PFD knobs is by default on the left-hand side of the display, and "alternate" knobs on the right. This can be changed by pressing the **MENU** key twice and touching the **PFD** icon, then changing **PFD Split Screen Side** from Right to Left.

By default the main inner knob will adjust the HSI's heading bug, and the main outer knob will adjust the altitude bug. The alternate inner knob will adjust the HSI course selection (in OBS mode), and the alternate outer knob will adjust the local barometric pressure setting.



The functionality of the alternate knobs can be changed through the **Right Side Knob Action** option in the PFD Setup menu. Note that this setting's name can change to **Left Side Knob Action** if the split screen is set to Left instead of the default Right.

The other settings available for the alternate knobs are **FD Bug/Baro** and **Heading/Altitude**. FD Bug/Baro will set the alternate inner knob to adjust the Flight Director bug if the Flight Director is active, and outer knob for local barometric pressure. Setting the alternate knobs to Heading/Altitude will mirror the functions of the main knobs.

Additionally, the option to **Press To Toggle Knob Action** is available to get more functionality out of the PFD knobs. When enabled, pressing either inner knob will change the knobs between main knob functions and alternate knob functions. This feature is intended for cockpits that frequently use Split Screen features, since the split screen will reserve a knob for MFD functions. "Main" functions will always be Heading/Altitude, and "alternate" functions will be specified in the Right Side Knob Action setting (also known as Left Side Knob Action).

## MORE OPTIONS...

Touching **More Options...** opens the PFD Setup menu that allows customization of PFD appearance and functionality. Changing both PFD Presentation and Attitude Presentation to Round Gauges will configure the PFD to resemble a "six-pack" style panel of mechanical gauges.

- System Overview
- Flight Instruments
- EIS
- CNS Interface
- GPS Navigation
- Flight Planning
- Hazard Avoidance
- Additional Features
- AFCs
- Annun/Alerts
- Appendix
- Index

Option	Setting Description		
<b>PFD Presentation</b>	Changes the PFD indicators for airspeed, altitude, vertical speed, and turn coordinator between linear <b>Tapes</b> and circular <b>Round Gauges</b> .		
<b>Attitude Presentation</b>	Changes attitude indicator between <b>Full Screen</b> where the artificial horizon spans the whole screen, and <b>Round Gauge</b> .		
<b>Angle of Attack Alerts</b>	Toggles graphical and audible angle-of-attack alerts.		
<b>Wind Vector</b>	Off	Disables wind display.	
	Speed/Dir	Displays winds as a single arrow and speed.	
	Head/X-wind	Displays winds as head and crosswind components.	
<b>HSI Orientation</b>	Heading	HSI will always display magnetic heading	
	Auto Trk/Hdg	HSI will display ground track instead of magnetic heading when airborne and GPS data is available	
<b>CDI Scale</b>	Toggles the CDI Scale between 0.25 nm, 1.25 nm, 5.00 nm.		
<b>Pitch Offset</b>	Numerical entry for manually adjusting the G3X Touch's detection of aircraft's pitch.		
<b>Right Side Knob Action</b>		<b>Right inner knob</b>	<b>Right outer knob</b>
	Course/Baro	CRS value	Local barometric pressure
	FD Bug/Baro	Flight Director bug	Local barometric pressure
	Heading/Altitude	Heading bug	Altitude bug
<i>NOTE: if the PFD Split Screen Side is set to Right in Display Settings, this option will appear as "Left Side Knob Action."</i>			
<b>Press To Toggle Knob Action</b>	When enabled, pressing an inner knob will toggle the functionality of inner and outer knobs. Knobs revert to previous functions after 10 seconds. Useful for situations where the split-screen is frequently used.		
<b>G Meter</b>	Off	Disables G Meter.	
	Auto Display	G Meter appears in place of HSI when G3X Touch detects G load above +2.1G or below -0.5G.	
	On (Replace HSI)	G Meter replaces HSI.	
<b>Lateral Deviation</b>	Toggles lateral deviation indicator.		
<b>Synthetic Vision</b>	Overlays 3D-rendered terrain on full-screen attitude presentation.		
<b>Ft. Path Marker</b>	Overlays a marker  on full-screen attitude presentation indicating aircraft bearing relative to heading, as affected by winds.		
<b>Pathways</b>	Overlays 3D magenta flight path boxes on full-screen attitude presentation, indicating path to next waypoint.		
<b>Traffic</b>	Overlays indications of specific aircraft on full-screen attitude presentation.		

## More PFD Options

## G3X TOUCH SYSTEM ANNUNCIATIONS

When an LRU or an LRU function fails, a large red 'X' is typically displayed over the instrument(s) or data experiencing the failure. Upon G3X Touch power-up, certain instruments remain invalid as equipment begins to initialize. All instruments should be operational within one minute of power-up. If any instrument remains flagged, and it is not likely an installation related problem, the G3X Touch should be serviced by a Garmin-authorized repair facility.

## AHRS OPERATION

The Attitude and Heading Reference System (AHRS) performs attitude, heading, and vertical acceleration calculations for the G3X Touch System, utilizing GPS, magnetometer, and air data in addition to information from its internal sensors. Attitude and heading information are updated on the PFD while the AHRS receives appropriate combinations of information from the external sensor inputs.

The AHRS (GSU 25) corrects for shifts and variations in the Earth's magnetic field by applying the Magnetic Field Variation Database. The Magnetic Field Variation Database is derived from the International Geomagnetic Reference Field (IGRF). The IGRF is a mathematical model that describes the Earth's main magnetic field and its annual rate of change. The database is updated approximately every 5 years via a GDU software update. Failure to update this database could lead to erroneous heading information being displayed to the pilot.

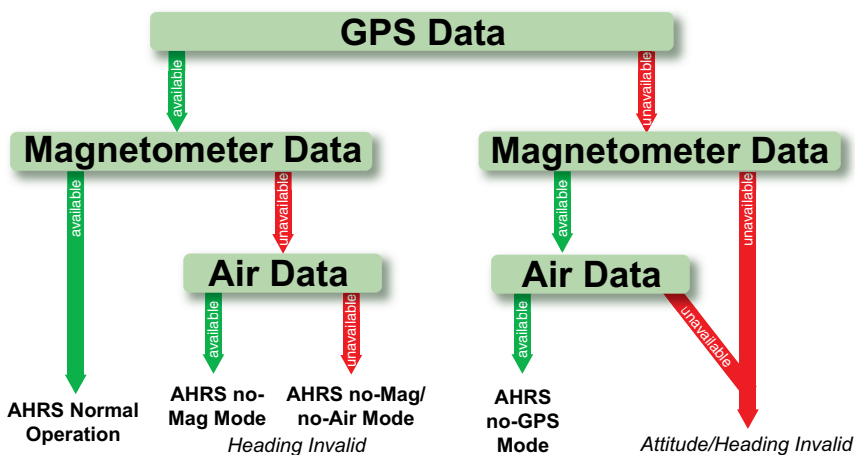

Loss of GPS, magnetometer, or air data inputs is communicated to the pilot by message advisory alerts. Any failure of the internal AHRS inertial sensors results in loss of attitude and heading information (indicated by red 'X' flags over the corresponding flight instruments). If the G3X Touch senses that the magnetic heading measurement is valid, but possibly outside of the internal accuracy limits, the numeric heading value on the PFD is displayed in yellow.

If GPS input fails, the AHRS can continue to provide attitude and heading information to the PFD as long as magnetometer and airspeed data are available and valid.

If the magnetometer input fails, the AHRS continues to output valid attitude information; however, the heading output on the PFD Page is flagged as invalid with a red 'X'.

Failure of the air data input has no effect on the AHRS output while AHRS is receiving valid GPS information. Invalid/unavailable airspeed data in addition to GPS failure results in loss of all attitude and heading information. Likewise, loss of magnetometer (heading) data, in combination with loss of GPS data results in a loss of all attitude and heading information.

In installations that include multiple AHRS units, (G3X Touch supports up to three AHRS sources) if data from an AHRS source is lost the G3X Touch will automatically switch sources, when a failure is detected. Reversionary sensor selection is annunciated in a window on the right side of the PFD. These annunciations reflect reversionary sensors selected on the PFD. Press the **Menu** Key while on the PFD page to access the PFD Options page and change the desired ADAHRS source (**AUTO**, **ADAHRS1**, or **ADAHRS2**). This allows for manual switching of the ADAHRS sensors being viewed on the PFD. The GPS sensor cannot be switched manually.

If a standby flight display (such as a Garmin G5 Electronic Flight Instrument) is installed, it will also provide a redundant source of attitude and air data in addition to that provided by the dedicated ADAHRS units (GSU 25 or GSU 73). If the sensor source selection is AUTO and attitude or air data is unavailable from any dedicated ADAHRS unit, the PFD will automatically revert to displaying data from the standby display. This will be annunciated on the PFD with an 'AHRS REVERT' or 'ADC REVERT' message (see section 10.4).

## 1.6 ACCESSING SYSTEM FUNCTIONALITY

### MENUS

The G3X Touch has a dedicated **MENU** Key. Press **MENU** once to display a context-sensitive list of options for the page or the dedicated PFD. Press **MENU** twice to display the Main Menu.

The Page Menu allows the user to access additional features or make setting changes which specifically relate to the currently displayed page. The menu will display 'No Options' when there are no options for the page selected.

### DATA ENTRY

Data can be entered by using the touchscreen or the knob. In some instances, such as when entering an identifier, the G3X Touch tries to predict the desired identifier based on the characters being entered. In this case, if the desired identifier appears, touch **Enter** to confirm the entry without entering the rest of the identifier manually. This can save the pilot from having to enter all the characters of the identifier.

Instead of using character-by-character data entry, touch **Find** to search by recent waypoints, nearest waypoints, flight plan waypoints, user waypoints, name, or city.

#### Entering data:

- 1) With the keypad displayed, begin entering data.
  - a) Touch the desired letters and/or numbers. Touch **Numeric** to access the numbers on a GDU 45X.
  - b) Touch **Enter**.

**Or:**

  - a) Touch **Find**.
  - b) Touch the **Recent, Nearest Airports, Flight Plan, User, Search Name**, or **Search City** Tab.
  - c) Touch the desired waypoint from the list.

**Or:**

  - a) Turn the small Knob below the keypad to activate the cursor and enter the first letter and/or number.
  - b) Turn the large Knob below the keypad to move the cursor to the next character position.
  - c) Repeat steps 'b' and 'c' as necessary.
  - d) Touch **Enter** or press the Knob below the keypad.

- System Overview
- Flight Instruments
- EIS
- CNS Interface
- GPS Navigation
- Flight Planning
- Hazard Avoidance
- Additional Features
- AFCs
- Annun/Alerts
- Appendix
- Index



Data Entry

## PAGES

A page navigation bar is displayed on the lower portion of the MFD. The right side shows a list of abbreviated names for each of the pages, and the left side shows the name of the current page.

Touch the page navigation bar to select the desired page or turn the large Knob associated with the MFD to cycle through the pages.



Page Navigation

## MAIN PAGES



**NOTE:** Contact Vertical Power for more information regarding the VP-X Page.

### Selecting a main page:

- 1) Touch the Page Navigation Bar on the MFD.
- 2) Touch the desired page from the Select Page menu.

**Or:**

Turn the large Knob associated with the MFD.

- **Main Pages**

Map Page (Map)

Traffic Page (TRF)\*

Charts Page (Cht)

Video In (Vid)\*

Waypoint Page (Wpt)

SiriusXM Page (SXM)\*

Active Flight Plan Page (FPL)

Vertical Power (VP-X)\*

SXM Weather Page (Wx) (optional)

Info Page (Info)

Terrain Page (Ter)

Engine Page (Eng)\*

\*May not be available, dependent upon configuration

## NEAREST PAGES

The Nearest Pages are selected by pressing the **NRST** Key.

### Selecting the NRST pages:

- 1) Touch the **NRST** Key.
- 2) Touch the Page Navigation Bar.
- 3) Touch the desired page from the Select Page menu.

**Or:**

Turn the large Knob associated with the MFD.

The Nearest Pages contain the following information.

- APT (Airport)—identifier, bearing, distance, length of the longest runway, and common traffic advisory (CTAF) or tower frequency.
- WX (Airport Weather) (GDU 455/465 only or GDU 450/460 w/GDL 39)—identifier, bearing, distance, METAR text, and ATIS, AWOS, or ASOS frequency.
- VOR (VHF Omnidirectional Radio Beacon)—identifier, facility type (symbol), bearing, distance, and frequency.
- NDB (Non Directional Beacons)—identifier, facility, type (symbol), bearing, distance, and frequency.
- INT (Intersection)—identifier, bearing, and distance.
- VRP (Visual Reporting Point) (Atlantic)—identifier, bearing, and distance.
- USR (User Waypoints)—name, bearing, and distance.
- CTY (City)—name, bearing, and distance.
- ATC (Air Route Traffic Control Center)—bearing, distance, and frequency.
- FSS (Flight Service Station)—name, bearing, distance, frequency, and VOR (if applicable).
- ASPC (Airspace)—name, time to entry (when applicable), and status.



## 1.7 ACCESSING ADDITIONAL INFORMATION



**NOTE:** A System Status Message and the word 'External' appearing next to the GPS Status indicates that the display connected to the GPS antenna is unavailable and the remaining display(s) are using the external GPS navigator for 2D GPS position data. In this case, the data collected from the external navigator is not considered a sufficient source of GPS data by the AHRS.

### VIEWING GPS RECEIVER STATUS

Internal system checking is performed to ensure the GPS receiver is providing accurate data to the GDU(s).

The G3X Touch GDUs can be configured to share GPS information (refer to the G3X Touch Installation Manual for configuration information). For example, a GDU can be configured to share its GPS position, velocity, and time data with another GDU. If a GDU is not using its own GPS receiver, the name of the GDU providing the data (i.e., '3D GPS Location (PFD)' or '3D GPS Location (MFD)') is displayed on the INFO Page.

The GPS Status will display one of the following conditions:

- Autolocate—Receiver is looking for any satellite whose almanac has been collected, which can take up to 5 minutes
- Searching the Sky—Receiver is looking for satellites
- Acquiring Satellites—Receiver is looking for and collecting data from satellites visible at its last known or initialized location, but has not acquired a fix
- 2D GPS Location—At least three satellites have been acquired and a two-dimensional location fix has been calculated. "2D Differential" appears when you are receiving DGPS corrections in 2D mode
- 3D GPS Location—At least four satellites have been acquired and a three-dimensional fix has been calculated. "3D Differential" appears when you are receiving DGPS corrections in 3D mode
- Lost Satellite Reception—the receiver is no longer tracking enough satellites for a 2D or 3D fix

## Viewing GPS receiver status information:

Turn the large Knob associated with the MFD to select the Info Page.

**Or:**

- 1) Touch the Page Navigation Bar on the MFD.
- 2) Touch the **Info** Page from the Select Page menu.

## NEW LOCATION

The 'New Location' menu option on the **Info** Page is used when the GPS Receiver is having trouble finding the satellites it expects to be there.

### Entering a new location:

- 1) From the **Info** Page, while the unit is searching for satellites, press the **MENU** Key.
- 2) Touch **New Location**.
- 3) Touch **Automatic, Use Map**, or **Use Identifier**.
- 4) After selecting your approximate position using the map or entering an identifier, touch **Enter**.
- 5) The GPS Receiver will begin a new search based on the location entered.

## ACQUIRING SATELLITES

When the receiver is in the process of acquiring enough satellite signals for navigation, the receiver uses satellite orbital data (collected continuously from the satellites) and last known position to determine the satellites that should be in view. "Acquiring Satellites" is indicated as the solution until a sufficient number of satellites have been acquired for computing a solution.

When the receiver is in the process of acquiring a 3D differential GPS solution, "3D GPS Location" is indicated as the solution until the 3D differential fix has finished acquisition.

## SATELLITE INFORMATION

Satellites currently in view are shown at their respective positions on a satellite constellation diagram. The outer circle of the constellation diagram represents the horizon, the inner circle represents 45° above the horizon, and the center point shows the position directly overhead. Each satellite is represented by a square containing the Pseudo-Random Noise (PRN) number (i.e., satellite identification number).

The **Info** Page can be helpful in troubleshooting weak (or missing) signal levels due to poor satellite coverage or installation problems. As the GPS receiver locks onto satellites, a signal strength bar is displayed for each satellite in view, with the appropriate satellite PRN number (01-32 or 33-64 for WAAS) below each bar. The progress of satellite acquisition is shown in three stages, as indicated by signal bar appearance:

- No bar—Receiver is looking for the indicated satellite
- Gray bar—Receiver has collected the necessary data and the satellite signal can be used
- Green bar—Satellite is being used for the GPS solution

## POSITION

The Position box on the **Info** Page displays latitude, longitude, accuracy (in feet), reference waypoint, type, distance, direction, and bearing. The current position can be marked as a user waypoint by touching the latitude and longitude button. The reference waypoint is designed to display the current position in relation to a prominent landmark. The pilot can change the reference waypoint 'Nearest Type' using the 'Change Nearest Type' page menu option. By default the Nearest Type is set to 'Automatic', which will display the nearest large airport, enroute VOR, or city (in that order).

### Changing the Nearest Type:

- 1) From the **Info** Page, press the **MENU** Key.
- 2) Touch **Change Nearest Type**.
- 3) Touch **Automatic, Airport, VOR, NDB, Intersection, City, or Waypoint**.

### Marking Current Location as a Waypoint:

- 1) From the **Info** Page, touch the latitude and longitude.

**Or:**

- 1) From the **Info** Page, press the **MENU** Key, and touch **Mark Waypoint**.
- 2) Touch **Yes** on the confirmation dialog box.
- 3) Optionally touch the **Name** field to rename the waypoint.
- 4) Touch **Back**.

## 1.8 SYSTEM SETTINGS

The Setup option in the Main Menu allows management of the following system parameters:

- Transponder (optional)
- Alarms
- Data Bar
- Airspace
- Display
- Weather
- Sound
- Bluetooth
- Units
- PFD
- Time
- Angle of Attack
- Map
- Autopilot (optional)
- Position
- Flight Director (optional)

### Accessing system settings:

- 1) Press the **MENU** Key twice.
- 2) Touch **Setup**.
- 3) Touch the desired option on the Setup Page.

## TRANSPONDER

If configured to 'Set By Pilot' in configuration mode, (refer to the Installation Manual for configuration information) the pilot can change the Flight ID and enable/disable ADS-B Transmit from the Transponder Setup Page and the Transponder Pop-up Window.

### Setting the Flight ID:

- 1) Press the **MENU** Key twice.
- 2) Touch **Setup > Transponder**.
- 3) Touch the 'Flight ID' Field.
- 4) Enter the Flight ID and touch **Enter**.

### Or:

- 1) Touch the Transponder on the PFD.
- 2) Touch the 'Flight ID' Field.
- 3) Enter the Flight ID and touch **Enter**.

### Enabling/disabling ADS-B Transmit:

- 1) Press the **MENU** Key twice.
- 2) Touch **Setup > Transponder**.
- 3) Touch the 'ADS-B Transmit' Field.
- 4) Touch **Enabled** or **Disabled**.

## DATA BAR SETUP



Data Bar - GDU 465 with COM radio

### Displaying the Data Bar Setup Page:

- 1) Press the **MENU** Key twice.
- 2) Touch **Setup > Data Bar**.

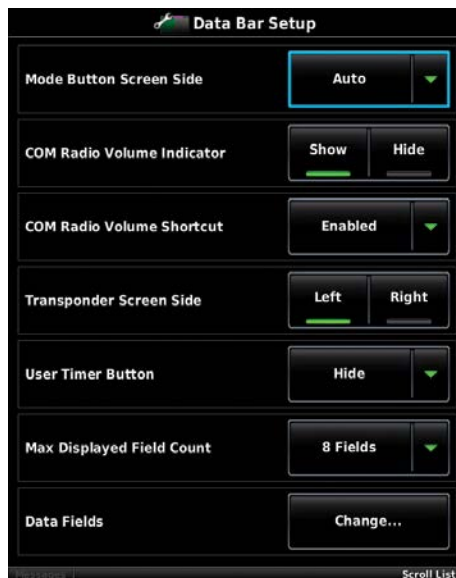

Data Bar Setup Page

## MODE BUTTON SCREEN SIDE

Determines which side of the display the Mode Button  is shown. Settings are **Auto**, **Left**, and **Right**.

## COM RADIO VOLUME INDICATOR

Used to display (temporarily) volume indicator  on the Data Bar, settings are **Show** and **Hide**.

## COM RADIO VOLUME SHORTCUT

When enabled, this option provides quick access to the selected COM radio volume control by dedicating one of the GDU knobs to volume and squelch when the tune radio page is the active page (**Set Volume / Push Squelch** annunciated on screen just above knob). When disabled, the tune radio page dedicates all available knobs to setting and tuning the standby frequency (i.e., a single knob in split-screen display mode, or both knobs in full-screen display mode).

## AUDIO PANEL VOLUME SHORTCUT

Audio Panel Volume Shortcut is available when a GMA 245/245R audio panel is connected. When enabled, this option provides quick access to the intercom, music and Bluetooth audio volume control by dedicating one of the GDU knobs to volume when the audio panel page is the active page (**Pilot ICS** ↔ **Copilot ICS** annunciated on screen just above knob).

## TRANSPONDER SCREEN SIDE

Adjusts the position of the transponder control to either the **Left** or **Right** side of the Data bar.

## USER TIMER BUTTON

Used to change the display of the User Timer Button  on the Data Bar. Selections are: Hide, Show on Left, and Show on Right. The User Timer can also be accessed from the User Timer icon on the Main Menu, and from the PFD Option Menu. Press the User Timer Button to start/stop the timer, press Reset to reset the timer.

## MAX DISPLAYED FIELD COUNT

Used to select the maximum number (1-8) of available data boxes shown on the Data Bar.

## DATA FIELDS

Refer to the Annunciations and Alerts Section for a list of available Data Bar Field options.

### Changing the information shown in the data bar fields:

- 1) Press the **MENU** Key twice.
- 2) Touch **Setup > Data Bar > Change....**
- 3) Touch one of the data bar fields.
- 4) Touch a new data field from the list.

## DISPLAY

### BACKLIGHT SETTINGS

The Backlight Intensity (display brightness) can be set to 'Manual', 'Light Bus', or 'Photo Cell'. With 'Manual' selected, the pilot can manually adjust the desired backlight intensity. After each power cycle the Backlight Intensity is set to the default, which is configurable. Refer to the G3X Touch Installation Manual for more information.

### EIS DISPLAY LOCATION (OPTIONAL)

In Configuration Mode the 'EIS Display Location' setting can be set to one of the following:

- **AUTO**—Displays the EIS Strip on the MFD, or on the PFD1 (and PFD2 if applicable) if the MFD is not displayed.
- **PFD**—Always displays the EIS Strip on PFD1 (and PFD2 if applicable).
- **User Selected**—Enables the user to choose between 'AUTO' and 'PFD' via the Display Setup menu.

For more information on how to enable the 'EIS Display Location' setting in Configuration Mode refer to the G3X Touch Installation Manual.

### SCREENSHOT

#### Saving a Screenshot to the SD Card (if Screenshot function is enabled):

- 1) Navigate to the desired screen.
- 2) Press and hold the MENU Key. A 'Screenshot saved to card' message will appear.

## SCREEN CLEANING

### Cleaning the display:

- 1) Press the MENU Key twice.
- 2) Touch Tools > Screen Cleaning.
- 3) Clean screen with a clean, lint-free cloth (such as the Garmin cleaning cloth). Avoid any chemical cleaners or solvents that can damage plastic components.
- 4) Per the on-screen instructions, press the MENU Key to swap sides of the display, or press the BACK Key to return to Tools.



**NOTE:** Make sure that no dust or grit accumulates at the bottom of the display glass. The GDU displays use invisible infrared beams for touch detection, this makes it very important to keep the screen clean, especially along the edges.

## DISPLAY SETUP PAGE

### Accessing Display Setup Options:

- 1) Press the **MENU** Key twice.
- 2) Touch **Setup > Display**.

Setting	Options	Description	Notes
Backlight Control	Manual	Provides configurable manual control	
	Light Bus	Adjusts backlight according to external cockpit control, if connected	
	Photo Cell	Uses bezel light sensor to automatically adjust backlight to complement ambient light level	
Backlight Intensity	Slider Control	Directly sets backlight level if Backlight Control is set to Manual	
Startup Page	Page	List of specific pages to display on startup. Auto will display last page before shutdown.	GDU 46X only
PFD Startup Page	Left	If Split Screen on startup is enabled, specifies the side the non-PFD page appears	GDU 46X PFD only
	Right		



### Display Setup Options



Setting	Options	Description	Notes
Startup Page	Full	Enables or disables Split Screen on startup	GDU 45X only
	Split		
PFD Inset Page	Flight Plan	Specifies the page to display in Inset section after switching to Split Screen	GDU 45X PFD only
	Video Input		
	Traffic		
PFD Inset Page Screen Side	Left	Specifies location of inset screen while in Split Screen	GDU 45X PFD only
	Right		
Full MFD/ PFD Toggle	Enable	Shows or hides MFD/PFD toggle button	GDU 45X MFD only
	Disable		
MFD Split Screen Page	Map	Specifies page to display after switch MFD to Split Screen	GDU 46X MFD only
	Chart		
	PFD		
Split Screen Side	Left	Specifies which side the Split Screen appears on	GDU 46X only
	Right		
PFD Split Screen Ratio	Narrow	Narrower PFD, wider Split Screen	GDU 46X PFD only
	Normal	Equal PFD and Split Screen areas	
	Wide	Wider PFD, narrower Split Screen	
EIS Display Location	MFD	Specifies which displays show the Engine Indication System strip	
	PFD		
	Both		
MFD EIS Screen Side	Left	Specifies which side of MFD that the EIS strip appears on	GDU 45X MFD or GDU 46X MFD only
	Right		
Audio Panel Display	MFD	Specifies which displays show the Audio Panel	
	PFD		
	Both		

### Display Setup Options

- System Overview
- Flight Instruments
- EIS
- CNS Interface
- GPS Navigation
- Flight Planning
- Hazard Avoidance
- Additional Features
- AFCS
- Annun/Alerts
- Appendix
- Index

Setting	Options	Description	Notes
Transponder Display Location	MFD	Specifies which displays show the Transponder button	
	PFD		
	Both		
COM Radio Display Location	MFD	Specifies which displays show the COM Radio Display	
	PFD		
	Both		
On-Screen Zoom Buttons	Show	Shows or hides zoom buttons  	
	Hide		
Knob Zoom Action	Normal	Clockwise zooms in, in Maps and Charts	
	Reverse	Clockwise zooms out, in Maps and Charts	
Map Color Mode	Day	Full color map features	
	Night	High-contrast mode	
	Auto	Change depending on local time	
Chart Color Mode	Day	Full color chart features	
	Night	High-contrast mode	
	Auto	Change depending on local time	
Video Main Page	Show	Video Input (VID) page is available through the MFD page navigation bar	
	Hide	Video Input page is available through the Tools item in the main menu	
Screenshot	Disabled	Allows capturing of screenshots. Field is available immediately when an SD card is inserted. See Appendix C.	
	Enabled		

### Display Setup Options

## SOUND

The pilot can manually adjust the desired SXM Volume, Message Volume, Altitude Alert (On/Off), and Minimums Alert (On/Off). Message Volume controls the banner message tones (e.g., "Approaching Airspace" or "Arriving at Waypoint"). Alert Volume (e.g., terrain, traffic, autopilot, etc.) is set in configuration mode (refer to the G3X Touch Installation Manual for more information).

### Adjusting SXM and/or Message Volume:

- 1) Press the **MENU** Key twice.
- 2) Touch **Setup** > **Sound**.
- 3) Touch the 'SXM Volume' or 'Message Volume' Field.
- 4) Touch and drag the slider to the desired percentage.

### Turning the altitude alert tone on/off:



**NOTE:** Refer to the *Flight Instruments* section for more information regarding the *Altitude Alert Tone*.

- 1) Press the **MENU** Key twice.
- 2) Touch **Setup** > **Sound**.
- 3) Touch **On** or **Off** in the 'Altitude Alert' Field.

### Turning the minimums alert tone on/off:



**NOTE:** Refer to the *Flight Instruments* section for more information regarding the *Minimums Alert Tone*.

- 1) Press the **MENU** Key twice.
- 2) Touch **Setup** > **Sound**.
- 3) Touch **On** or **Off** in the 'Minimums Alert' Field.

## Enable/disable the 'Traffic Not Available' audio alert:



**NOTE:** Refer to the Hazard Avoidance section for more information regarding the 'Traffic Not Available' audio alert.

- 1) Press the **MENU** Key twice.
- 2) Touch **Setup** > **Sound**.
- 3) Touch **On** or **Off** in the 'Traffic N/A Alert' Field.

## UNITS

### Changing unit settings:

- 1) Press the **MENU** Key twice.
- 2) Touch **Setup** > **Units**.
- 3) Touch the desired field.
- 4) Touch the desired units.

## TIME

### Enabling/disabling Auto UTC Offset:

- 1) Press the **MENU** Key twice.
- 2) Touch **Setup** > **Time**.
- 3) Touch **On** or **Off** in the 'Auto UTC Offset' Field.

### Changing the time format:

- 1) Press the **MENU** Key twice.
- 2) Touch **Setup** > **Time**.
- 3) Touch the 'Time Format' Field.
- 4) Touch **12 Hour**, **24 Hour**, or **UTC**.

## POSITION



**NOTE:** Refer to Appendix D for more information on Map Datums and Location Formats.



**NOTE:** 'Heading' and 'Mag. Variation' settings always display magnetic heading and have no effect on the HSI since they are driven by the magnetometer data.

### Changing position settings:

- 1) Press the **MENU** Key twice.
- 2) Touch **Setup > Position**.
- 3) Touch the desired field to change.
- 4) Touch the desired setting from the list.

## ALARMS

The Alarms Page allows the pilot to turn airspace alarms On/Off, set an Altitude Buffer, Arrival Alarm, Next Waypoint Alarm, Proximity Alarm, and Fuel Tank Reminder Alarm.

### Enabling/disabling the proximity waypoint alarm:

- 1) Press the **MENU** Key twice.
- 2) Touch **Setup > Alarms**.
- 3) Touch **On** or **Off** in the 'Proximity Waypoint' Field.

### Enabling/disabling the fuel tank reminder alarm:

- 1) Press the **MENU** Key twice.
- 2) Touch **Setup > Alarms**.
- 3) Touch **On** or **Off** in the 'Fuel Tank Reminder' Field.

### Enabling/disabling the arrival alarm:

- 1) Press the **MENU** Key twice.
- 2) Touch **Setup > Alarms**.
- 3) Touch **On** or **Off** in the 'Arrival' Field.
- 4) If necessary, touch the arrival distance value.
- 5) Enter the desired distance using the keypad and touch **Enter**.

### Changing the next waypoint alarm settings:

- 1) Press the **MENU** Key twice.
- 2) Touch **Setup > Alarms**.
- 3) Touch  to display the next waypoint alarm options.
- 4) Touch **Off**, **Distance**, or **Time**.
- 5) If **Time** is selected, touch + or - to adjust the time.
- 6) If **Distance** is selected, touch the distance value and enter the desired distance using the keypad.

## FUEL TANK REMINDER ALARM AND FUEL TANK TIMER

The 'Fuel Tank' Reminder alarm is used as a reminder to switch fuel tanks. The reminder message repeats at the specified interval after the beginning of each trip. The Fuel Tank Timer (FUEL TIMER) data field option is the elapsed time since the 'Fuel Tank' Reminder alarm was last issued (HH:MM).

## AIRPORT CRITERIA

The Page Menu on the Nearest Airports Page allows the pilot to filter out airports that do not meet a defined criteria. Specific surface types and runway lengths can be defined, as well as the option to include private airports and/or heliports.

- **Runway Surface:** Allows the pilot to set criteria for the type of surface on the runway.
  - Any: Shows any runway, regardless of surface type, including water landing facilities.
  - Hard only: Shows only runways with a concrete, asphalt, or similar sealed surface.
  - Hard or Soft: Shows all runways except water landing facilities.
  - Water only: Shows only water landing facilities.
- **Minimum Runway Length:** Allows the pilot to enter a specific length for the shortest runway allowed.
- **Include Private Airports:** Allows the pilot to include Private Airports in the search criteria.

### Entering airport criteria:

- 1) Press the **NRST** Key.
- 2) Press the **MENU** Key.
- 3) Touch the Runway Surface field and touch **Hard only**, **Hard/Soft**, **Water only**, or **Any**.

**Or:**

Touch the Min Runway Length value and enter the value using the keypad.

**Or:**

Touch **Private Airports**.

**Or:**

Touch **Heliports**.

- System Overview
- Flight Instruments
- EIS
- CNS Interface
- GPS Navigation
- Flight Planning
- Hazard Avoidance
- Additional Features
- AFCS
- Annun/Alerts
- Appendix
- Index

Blank Page



# SECTION 2 FLIGHT INSTRUMENTS

## 2.1 FLIGHT INSTRUMENTS



**NOTE:** Refer to Section 9 for Autopilot information.

Increased situational awareness is provided by replacing the traditional instruments on the panel with an easy-to-scan Primary Flight Display (PFD) that features a horizon, airspeed, attitude, altitude, vertical speed, heading, and course deviation information.



PFD (Full Screen)

The following flight instruments and supplemental flight data are displayed on the PFD.

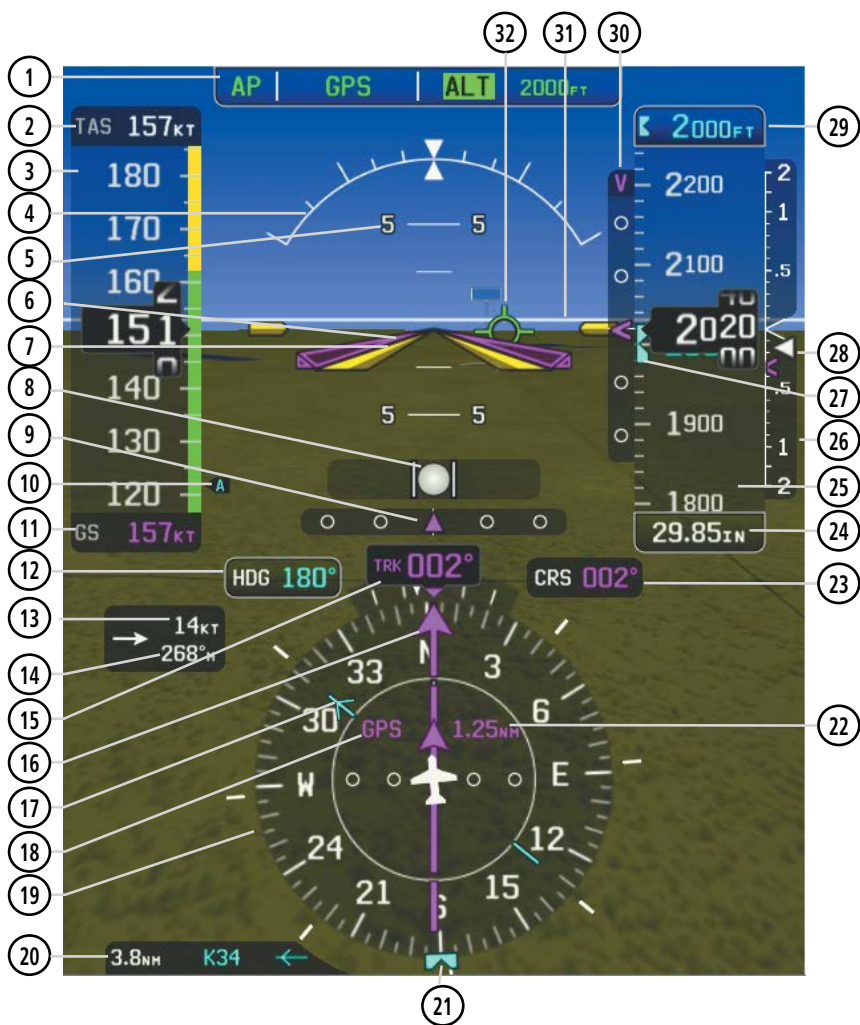

**NOTE:** GDU 46X displays can present the primary flight instruments in round gauge format. Access this setting via the "PFD Presentation" item on the PFD Setup page from the Main Menu and select "Round Gauges".

- System Overview
- Flight Instruments
- EIS
- CNS Interface
- GPS Navigation
- Flight Planning
- Hazard Avoidance
- Additional Features
- AFCs
- Annun/Alerts
- Appendix
- Index

- |  |   |
|--|---|
| 1 Autopilot Status Box                       | 17 Bearing 1 Pointer                              |
| 2 True Airspeed (TAS)                        | 18 Navigation Source                              |
| 3 Airspeed Indicator                         | 19 Horizontal Situation Indicator (HSI)           |
| 4 Attitude Indicator                         | 20 Bearing 1 Information                          |
| 5 Pitch Scale                                | 21 Selected Heading Bug                           |
| 6 Flight Director Command Bars               | 22 CDI Scale                                      |
| 7 Aircraft Symbol                            | 23 Selected Course                                |
| 8 Slip/Skid Indicator                        | 24 Altimeter Barometric Setting                   |
| 9 Lateral Deviation Scale & Course Deviation | 25 Altimeter                                      |
| 10 Vspeed Reference                          | 26 Vertical Speed Indicator (VSI)                 |
| 11 Ground Speed (GS)                         | 27 Selected Altitude Bug                          |
| 12 Selected Heading                          | 28 Current Vertical Speed                         |
| 13 Wind Speed                                | 29 Reference Altitude                             |
| 14 Wind Direction                            | 30 VNAV Indicator or Vertical Deviation Indicator |
| 15 Current Track Indicator                   | 31 Zero Pitch Line                                |
| 16 Course Deviation Indicator (CDI)          | 32 Flight Director                                |

- System Overview
- Flight Instruments
- EIS
- CNS Interface
- GPS Navigation
- Flight Planning
- Hazard Avoidance
- Additional Features
- AFCS
- Annun/Alerts
- Appendix
- Index

## AIRSPEED INDICATOR



**NOTE:** The G3X Touch Vspeed Reference values and Flaps Tick Mark values depend upon the aircraft's specific system configuration and may vary from the examples discussed in this section.

The Airspeed Indicator displays airspeed on a rolling number gauge using a moving tape. The true airspeed (TAS) is displayed in knots above the Airspeed Indicator. The numeric labels and major tick marks on the moving tape are marked at intervals of 10 knots. Speed indication starts at 30 knots, with 60 knots of airspeed viewable at any time. The actual airspeed is displayed inside the black pointer. The pointer remains black until reaching never-exceed speed ( $V_{NE}$ ), at which point it turns red.

A color-coded (red, white, green, yellow, and red/white “barber pole”) speed range strip is located on the moving tape. The colors denote flaps operating range, normal operating range, caution range, and never-exceed speed ( $V_{NE}$ ). A red range is also present for low speed awareness.

The Airspeed Trend Vector is a vertical, magenta line, extending up or down on the airspeed scale, shown to the right of the color-coded speed range strip. The end of the trend vector corresponds to the predicted airspeed in 6 seconds if the current rate of acceleration is maintained. If the trend vector crosses  $V_{NE}$ , the text of the actual airspeed readout changes to yellow. The trend vector is absent if the speed remains constant or if any data needed to calculate airspeed is not available due to a system failure.

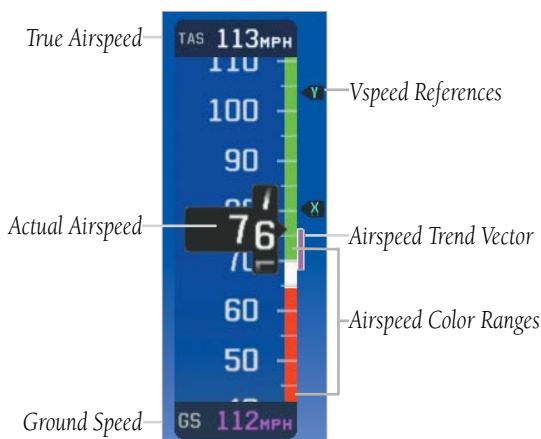

**Airspeed Indicator**

- System Overview
- Flight Instruments
- EIS
- CNS Interface
- GPS Navigation
- Flight Planning
- Hazard Avoidance
- Additional Features
- AFCs
- Annun/Alerts
- Appendix
- Index

## V<sub>NE</sub> ADJUSTED FOR TRUE AIRSPEED OR MACH NUMBER (OPTIONAL)

The airspeed indicator can optionally be configured to display V<sub>NE</sub> adjusted for true airspeed or maximum Mach number (MMO). This is useful in aircraft where true airspeed or Mach number must be kept below a certain limit. If configured, the G3X Touch PFD can calculate an adjusted V<sub>NE</sub> based on TAS or Mach in addition to IAS, which will cause the displayed value for V<sub>NE</sub> to be reduced at high altitudes. A solid red band is used between the TAS or Mach limit and the actual indicated value for V<sub>NE</sub>.

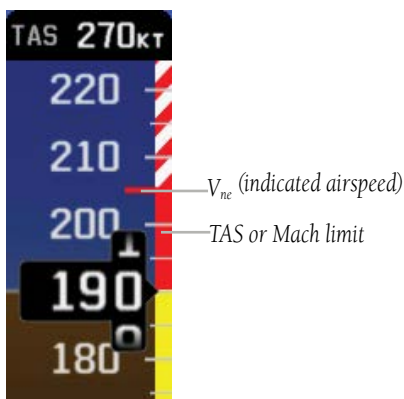

V<sub>ne</sub> Adjusted for True Airspeed

## VSPEED REFERENCE

Vspeed references including  $V_{NE}$ ,  $V_{no}$ ,  $V_{so}$ ,  $V_{s1}$ ,  $V_{fe}$ ,  $V_a$ ,  $V_x$ ,  $V_y$ ,  $V_{yset}$ ,  $V_g$ ,  $V_r$ , as well as several custom Vspeeds can be configured from the Aircraft Configuration Page, refer to the G3X Touch Installation Manual for more information.

When airspeed is present, the Vspeeds configured are also displayed at their respective locations to the right of the airspeed scale, otherwise the Vspeeds are displayed at the bottom of the airspeed indicator.

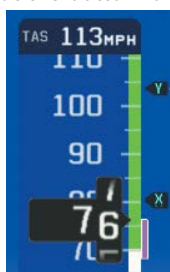

Vspeed References (with airspeed)



Vspeed References (without airspeed)

## ATTITUDE INDICATOR

Attitude information is displayed over a virtual blue sky and brown ground with a white horizon line. The Attitude Indicator displays the pitch (indicated by the yellow symbolic aircraft on the pitch scale), roll, and slip/skid information.

The horizon line is part of the pitch scale. Pitch markings occur at 2.5° intervals through all pitch ranges.

The inverted white triangle indicates zero on the roll scale. Major tick marks at 30° and 60° and minor tick marks at 10°, 20°, and 45° are shown to the left and right of the zero. Angle of bank is indicated by the position of the pointer on the roll scale.

Slip/skid is indicated by the location of the ball.

- System Overview
- Flight Instruments
- EIS
- CNS Interface
- GPS Navigation
- Flight Planning
- Hazard Avoidance
- Additional Features
- AFCs
- Annun/Alerts
- Appendix
- Index

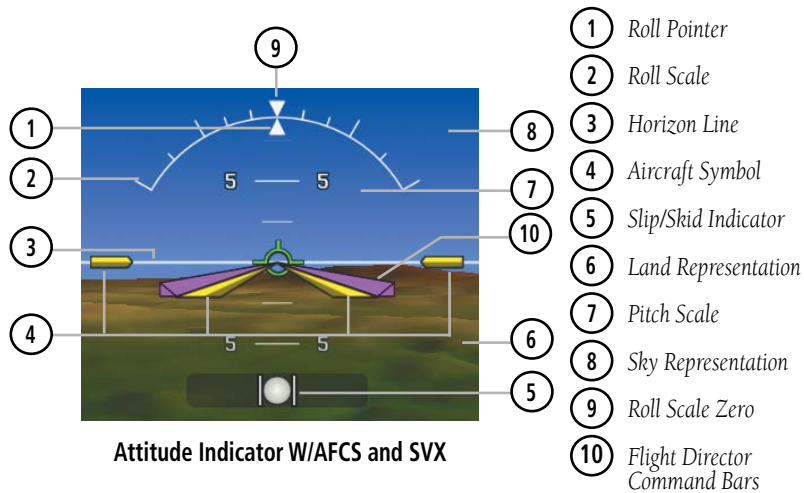
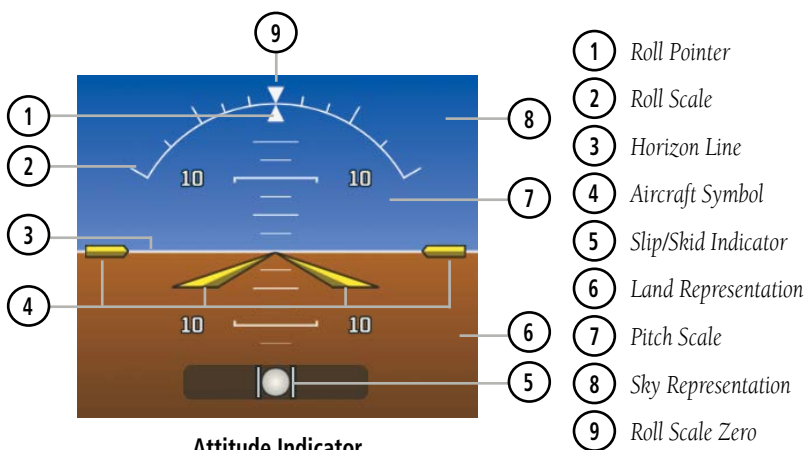

## ALTIMETER

The Altimeter displays 400 feet of barometric altitude values at a time on a rolling number gauge using a moving tape. Numeric labels and major tick marks are shown at intervals of 100 feet. Minor tick marks are at intervals of 20 feet. The current altitude is displayed in the black pointer.

The Selected Altitude is displayed above the Altimeter in the box indicated by a selection bug symbol. A bug corresponding to this altitude is shown on the tape; if the Selected Altitude exceeds the range shown on the tape, the bug appears at the corresponding edge of the tape.

### Setting the selected altitude:

Turn the large Knob associated with the PFD to set the Selected Altitude in 100-ft increments.

**Or:**

- 1) Touch the Selected Altitude.
- 2) Enter the desired altitude using the keypad and touch **Enter**.

### Syncing to the current altitude:

- 1) Touch the Selected Altitude.
- 2) Touch **Set to Current** and touch **Enter**.



**NOTE: Set to Current is only available when aircraft is on ground.**

### Syncing to the local barometric pressure setting:

- 1) From the PFD Page (one display) or PFD (two display), press the **BARO** Softkey.
- 2) While stationary on the ground, press and hold the **FMS** Joystick.
- 3) Verify indicated altitude matches local field elevation.



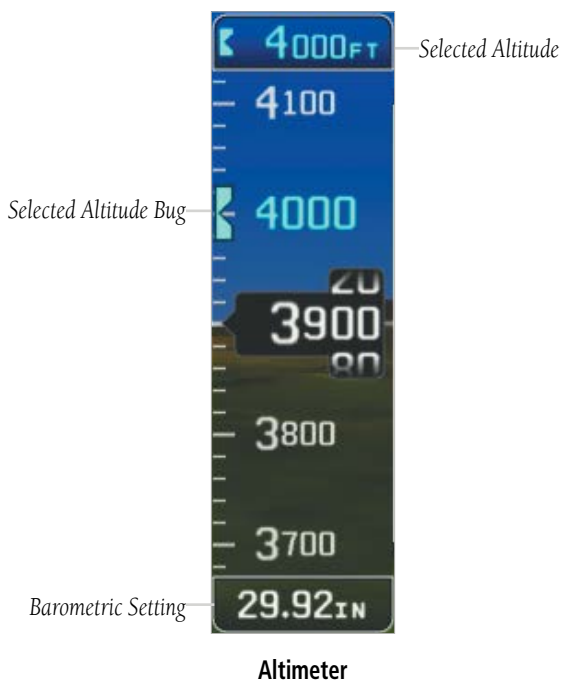

## BAROMETRIC PRESSURE

The barometric pressure setting is displayed below the Altimeter in inches of mercury (in Hg) or hectopascals (hPa) when metric units are selected.

### Selecting the altimeter barometric pressure setting:

Turn the large right Knob associated with the PFD to set the barometric pressure.

**Or:**

- 1) Touch the Barometric Pressure on the PFD.
- 2) Touch the **Set For Field** button if aircraft is on the ground.

**Or:**

- 3) Touch the **Set To Standard** button if aircraft is in the air.

**Or:**

- 4) Enter the desired pressure using the keypad and touch **Enter**.

## BAROMETRIC MINIMUM ALERT

For altitude awareness, a barometric Minimum Descent Altitude (MDA) or Decision Height (DH) can be set by the user and is reset when the power is cycled. Once the user-defined altitude is within the range of the tape, a light blue bug appears at the reference altitude on the Altimeter. Once the aircraft reaches the user-defined MDA/DH, the bug and text turn yellow and the aural alert, "Minimums Minimums", is heard.

*Light Blue Within Range*

*Yellow When Altitude Reached*

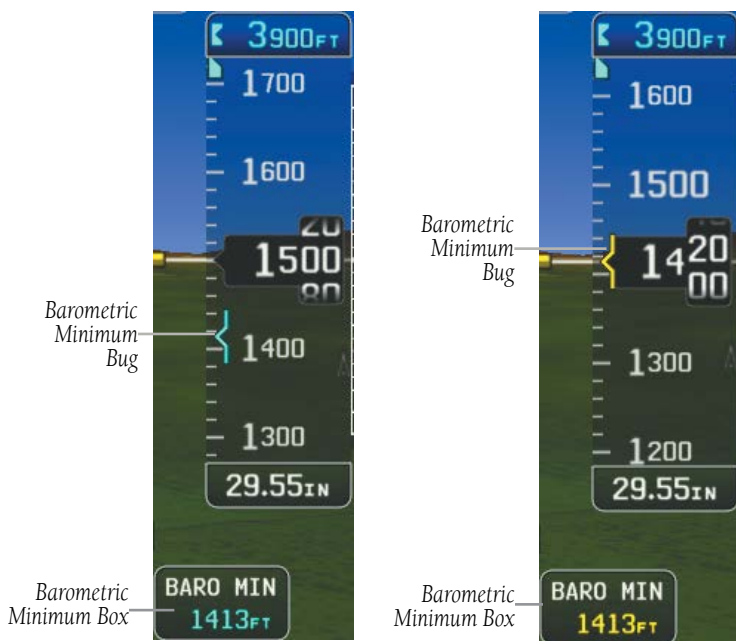

**Barometric Minimum Visual Annunciations**

### Setting the barometric minimum alert bug:

- 1) With the full screen PFD displayed, press the **MENU** Key.
- 2) Touch **Set...** in the Minimums Field.
- 3) Enter the minimum altitude using the keypad and touch **Enter**.

## Turning the minimums alert tone on/off:

- 1) Press the **MENU** Key twice.
- 2) Touch **Setup > Sound**.
- 3) Touch **On** or **Off** in the Minimums Alert field.

## ALTITUDE ALERTING

The Altitude Alerting function provides the pilot with visual and aural alerts when approaching the Selected Altitude. Whenever the Selected Altitude is changed, the Altitude Alerter is reset. The following will occur when approaching the Selected Altitude:

- Passing within 1000 feet of the Selected Altitude, the Selected Altitude (shown above the Altimeter) flashes for 5 seconds and an aural tone is generated.
- When the aircraft passes within 200 ft of the Selected Altitude, the Selected Altitude flashes for 5 seconds and an aural tone is generated to indicate that the aircraft is approaching the selected altitude.
- After reaching the Selected Altitude, if the pilot flies outside the deviation band ( $\pm 200$  Feet of the Selected Altitude), the Selected Altitude changes to yellow text on a black background, flashes for 5 seconds, and an aural tone is generated.

*Deviation of  $\pm 200$  ft*



**Altitude Alerting Visual Annunciation**

## Turning the altitude alert tone on/off:

- 1) Press the **MENU** Key twice.
- 2) Touch **Setup > Sound**.
- 3) Touch **On** or **Off** in the Altitude Alert field.

## VERTICAL SPEED INDICATOR (VSI)

The Vertical Speed Indicator displays the aircraft vertical speed using a non-moving tape labeled at 500, 1000 and 2000 fpm with minor tick marks every 100 feet up to 1000 fpm. The current vertical speed is displayed using a white arrow along the tape.

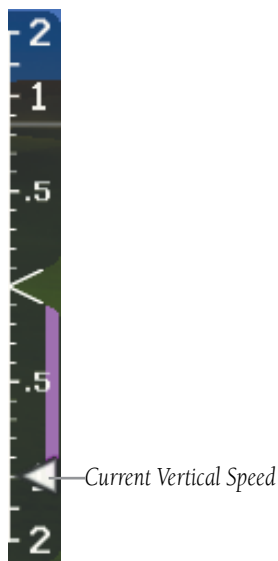

Vertical Speed Indicator

- System Overview
- Flight Instruments
- EIS
- CNS Interface
- GPS Navigation
- Flight Planning
- Hazard Avoidance
- Additional Features
- AFCS
- Annun/Alerts
- Appendix
- Index

## VERTICAL DEVIATION INDICATOR AND VNAV INDICATOR



**NOTE:** An external navigator (i.e., SL30 Nav/Comm Transceiver and/or the GTN or GNS Series Units) must be configured to receive glideslope and/or glidepath vertical deviation indications.

### GLIDESLOPE - ILS SOURCE

The Vertical Deviation (Glideslope) Indicator (VDI) appears to the left of the altimeter whenever an ILS frequency is tuned in the active NAV field of an external navigator. A green diamond acts as the VDI Indicator, like a glideslope needle on a conventional indicator. If a localizer frequency is tuned and there is no glideslope signal, "NO GS" is annunciated.

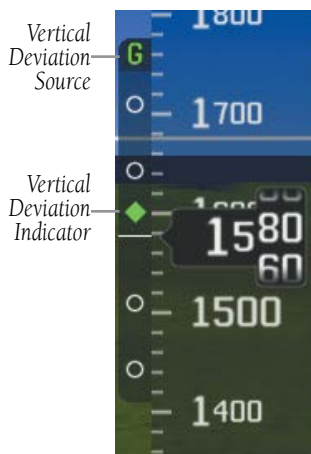

Vertical Deviation Indicator  
(Glideslope-ILS Source)

## GLIDEPATH - GPS SOURCE

The Vertical Deviation (Glidepath) Indicator (VDI) also appears to the left of the altimeter during a GPS approach. The glidepath is analogous to the glideslope for GPS approaches supporting WAAS vertical guidance (LNAV+V, L/VNAV, LPV). The Glidepath Indicator appears on the G3X Touch as a magenta diamond. If the approach type downgrades past the final approach fix (FAF), "NO GP" is annunciated.

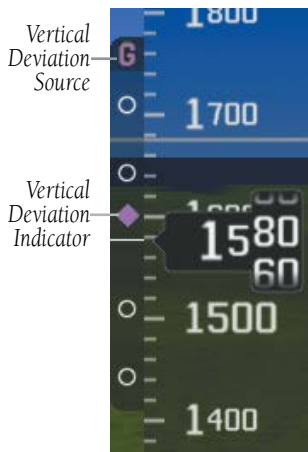

Vertical Deviation Indicator  
(Glidepath-GPS Source)

- System Overview
- Flight Instruments
- EIS
- CNS Interface
- GPS Navigation
- Flight Planning
- Hazard Avoidance
- Additional Features
- AFCS
- Annun/Alerts
- Appendix
- Index

## VNAV INDICATOR

An external navigation source is not required to receive VNAV indications. When the VNAV profile is defined, the pilot is informed of the progress by message alerts. A magenta chevron (VNAV Indicator) to the left of the altimeter on the Vertical Deviation Scale shows the VNAV profile, and a magenta chevron (Required Vertical Speed Indicator (RVSI)) on the Vertical Speed Indicator indicates the required vertical speed to reach the target altitude. Refer to section 2.3 for more information.



VNAV Indicator

## HORIZONTAL SITUATION INDICATOR (HSI)

The Horizontal Situation Indicator (HSI) displays a rotating compass card in a heading-up orientation at the bottom of the page. Letters indicate the cardinal points and numeric labels occur every 30°. Major tick marks are at 10° intervals and minor tick marks at 5° intervals. The current track is represented on the HSI by a magenta triangle and dashed line. The HSI also presents course deviation, bearing, and navigation source information.

The Selected Heading is shown to the left of the HSI. The light blue bug on the compass rose corresponds to the Selected Heading.

**Adjusting the selected heading:**

Turn the small left Knob associated with the PFD to adjust the selected heading.

**Or:**

- 1) Touch the selected heading on the PFD.
- 2) Enter the desired heading using the keypad and touch **Enter**.

**Syncing to the current heading:**

- 1) Touch the selected heading on the PFD.
- 2) Touch **Set To Current** and touch **Enter**.



- |  |                            |
|--|----------------------------|
| ① Course Deviation & To/From Indicator | ⑦ Rotating Compass Rose    |
| ② Selected Heading                     | ⑧ Selected Heading Bug     |
| ③ Current Heading                      | ⑨ Aircraft Symbol          |
| ④ Turn Rate Indicator                  | ⑩ To/From Indicator        |
| ⑤ Navigation Source                    | ⑪ Lateral Deviation Scales |
| ⑥ Course Deviation Indicator (CDI)     |                            |

**Horizontal Situation Indicator (HSI)**

- System Overview
- Flight Instruments
- EIS
- CNS Interface
- GPS Navigation
- Flight Planning
- Hazard Avoidance
- Additional Features
- AFCs
- Annun/Alerts
- Appendix
- Index



## HSI ANNUNCIATIONS



**NOTE:** Some or all HSI annunciations may appear in the four quadrants of the G3X Touch HSI depending on the external navigator(s) configured (i.e., SL30 Nav/Comm Transceiver and/or the GTN or GNS Series Units).

'1' or '2' will appear after the Navigation Source if more than one external navigation source is configured.

**LOI:** Loss of GPS integrity.

**VFR:** An external GPS source is configured but there is not enough guidance data for IFR use.

**REV:** External Navigation Source failed. Reverted to internal VFR GPS for navigation.

**MSG:** External navigation source has a pending message

**INT:** The pilot has elected to use the internal GPS navigation source instead of the external GPS navigation source.

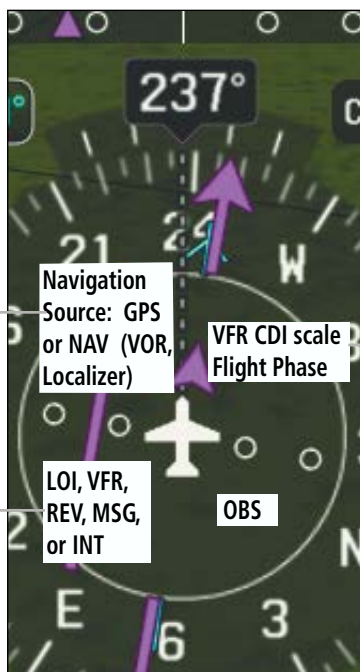

**VFR CDI Scales:**  
0.25nm, 1.25nm,  
5.00nm

**Flight Phase**  
(IFR): APR, TERM,  
ENR, OCN, LNAV,  
L/VNAV, LNAV+V,  
or LPV

HSI Annunciations

## BEARING POINTERS AND INFORMATION WINDOWS

Two bearing pointers and associated information can be displayed on the HSI for NAV (VOR, Localizer) and GPS sources as well as nearest airports. The bearing pointers are light blue and are single-line (Bearing Pointer 1) or double-line (Bearing Pointer 2). A pointer symbol is shown in the information windows to indicate the navigation source. The bearing pointers never override the CDI and are visually separated from the CDI by a white ring (shown when the bearing pointers are selected but not necessarily visible due to data unavailability).

When a bearing pointer is displayed, its associated information window is also displayed. The Bearing Information Windows are displayed at the lower sides of the HSI. The following information may be displayed in the Bearing Information Windows:

- Bearing source (NAV, GPS)
- Station/waypoint identifier (NAV, GPS)
- Pointer icon (single lined or double lined)
- GPS-derived great circle distance to bearing source
- Frequency (NAV)

If an external NAV radio is the bearing source and it is tuned to an ILS frequency, the bearing source and the bearing pointer are removed from the HSI and the frequency is replaced with "ILS". If VLOC1 or VLOC2 is the bearing source and it is tuned to a VOR frequency, the frequency is replaced with the station identifier. If GPS is the bearing source, the active waypoint identifier is displayed in lieu of a frequency.

The bearing pointer is removed from the HSI and "NO DATA" is displayed in the information window if:

- The NAV radio is not receiving the tuned VOR station
- GPS is the bearing source and an active waypoint is not selected



**HSI with Bearing Pointers**

## Enabling/disabling the bearing pointer and changing sources:

- 1) With the full screen PFD displayed, press the **MENU** Key.
- 2) Touch  next to a bearing pointer to display the bearing pointer options.
- 3) Touch one of the available options or touch **Off**.

## COURSE DEVIATION INDICATOR (CDI)

The HSI contains a Course Deviation Indicator (CDI), with a Course Pointer, To/From Indicator, and a sliding deviation bar and scale. The course pointer is a single line arrow (GPS1, VOR1, and LOC1) or a double line arrow (GPS2, VOR2, and LOC2) which points in the direction of the set course. The To/From arrow rotates with the course pointer and is displayed when the active NAVAID is received.

The Course Deviation Indicator (CDI) moves left or right from the course pointer along a lateral deviation scale to display aircraft position relative to the course. If the course deviation data is not valid, the CDI is not displayed.

Another Lateral Deviation Scale and combination Course Deviation and To/From Indicator is located below the slip/skid indicator.

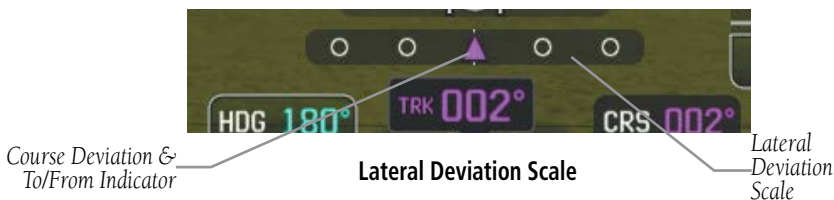

The CDI is capable of displaying two sources of navigation: GPS or NAV (VOR, localizer) depending on the external navigator(s) configured (refer to the G3X Touch Installation Manual for more information). Color indicates the current navigation source: magenta (for GPS) or green (for VOR and LOC). The full-scale limits for the CDI are defined by a GPS-derived distance when coupled to GPS. When coupled to a VOR or localizer (LOC), the CDI has the same angular limits as a mechanical CDI. If the CDI exceeds the maximum deviation on the scale (two dots) while coupled to GPS, the crosstrack error (XTK) is displayed below the white aircraft symbol.

## CHANGING THE NAVIGATION SOURCE

### Changing the navigation source (GPS, VOR, LOC, or VLOC):

Use the associated external navigator to toggle between GPS and VOR/LOC source types. Refer to the appropriate external navigator Pilot's Guide (e.g., SL30 Nav/Comm Transceiver Pilot's Guide, or the GTN or GNS Series Pilot's Guides) for more information. When an external navigator is configured the internal GPS can still be used for VFR navigation.



**NOTE:** The G3X Touch internal GPS flight plan is only for VFR use.

## G-METER

Whenever the G load on the airplane goes above +2.1G or below -0.5G, the HSI is temporarily replaced with a large graphical G-meter. To remove the G-meter, touch the displayed **G-meter**. Regardless of the current G load, the HSI can be replaced with a G-meter by changing the 'G METER' setting on the PFD setup page. The G-meter will be displayed until the setting is changed to auto or the power is cycled. Small white triangles are used to indicate the minimum and maximum recorded G loads. When in the auto display mode, the G-meter will automatically be displayed when an unusual attitude is sensed (i.e., greater than +/- 65° roll or +30°/-20° pitch). Refer to the G3X Touch installation manual for more information on configuring the G-meter.

### Manually displaying the G-meter:

- 1) With the full screen PFD displayed, press the **MENU** Key.
- 2) Touch **More Options...**
- 3) Touch  in the **G Meter** group to display the G-meter options.
- 4) Touch **On (No HSI)**.

### Resetting the G-meter minimum and maximum markers:

- 1) With the full screen PFD displayed, press the **MENU** Key.
- 2) Touch **Reset G Meter**.



**G-meter**

## HSI ORIENTATION

The HSI may be configured to provide directional information in either ‘Heading’ or ‘Auto Trk/Hdg’ “Track-up” modes. Selecting Heading Mode orients the HSI to display aircraft heading in a conventional manner with heading shown at the top of the compass card as indicated by the lubber line. In ‘Auto Trk/Hdg’ “Track-up” mode, the aircraft symbol and lubber line move to indicate heading and wind correction while ground track is shown at the top of the compass card. While in ‘Auto Trk/Hdg’ the HSI will remain heading-based when the aircraft is on the ground or when the autopilot is in HDG mode. Refer to the G3X Touch installation manual for more information on configuring the HSI Orientation.

### Changing HSI orientation:

- 1) With the full screen PFD displayed, press the **MENU** Key.
- 2) Touch **More Options**.
- 3) Touch  in the **HSI Orientation** field to display the HSI Orientation options.
- 4) Touch **Heading** or **Auto Trk/Hdg**.

- System Overview
- Flight Instruments
- EIS
- CNS Interface
- GPS Navigation
- Flight Planning
- Hazard Avoidance
- Additional Features
- AFCs
- Annun/Alerts
- Appendix
- Index



Track up HSI

## PFD PITCH ATTITUDE OFFSET

The Pitch attitude offset function allows the yellow aircraft symbol on the attitude indicator to be adjusted up or down much like the aircraft on a mechanical attitude indicator. The pitch attitude can be adjusted as much as +/- 2.5°.

### Changing the PFD Pitch Attitude Offset:

- 1) With the full screen PFD displayed, press the **MENU** Key.
- 2) Touch **More Options**.
- 3) Touch the **Pitch Offset** value.
- 4) Enter the desired pitch offset using the keypad and touch **Enter**.

## MANUALLY SWITCHING BETWEEN INTERNAL AND EXTERNAL FLIGHT PLAN SOURCES

Touch **FPL Source > Internal** on the Active Flight Plan Page, to temporarily allow flight planning through the G3X Touch using the internal GPS flight plan when an external GPS Navigator is configured. Touch **FPL Source > External GPS** to return to the external GPS navigator's flight plan.

When manually selecting the internal GPS flight plan, 'INT' is displayed in light blue in the lower left quadrant of the HSI.

## FAILURE OF THE EXTERNAL GPS NAVIGATION SOURCE

If the external GPS navigation source fails, the system reverts to the internal GPS navigation source and 'REV' is shown in yellow in the lower left quadrant of the HSI.

### CDI SCALE SELECTION (INTERNAL GPS ONLY)



**NOTE:** When an external GPS navigator is in use, the pilot cannot change the CDI scale.

Three factors determine the default distance from the center of the CDI to full left or right limits:

- CDI scale = 1.25 nm - within 30 nm of any airport in the active route.
- CDI scale = 0.25 nm - on an approach leg or within 2 nm of the FAF or MAP.
- CDI scale = 5.0 nm - if the previous two conditions do not exist.

### AUTO-SLEWING

The G3X Touch will automatically slew the LOC course pointer to the correct final approach course when an ILS, LOC, BC, LDA, or SDF approach is active in the external navigator and the appropriate CDI and navigation source are selected on the G3X Touch.

#### Setting up Auto-Slew:

- 1) With the desired approach activated in the external navigator, verify the appropriate CDI Source is selected (i.e., GPS1 or GPS2).
- 2) Once inside the FAF (Final Approach Fix), the course pointer will change from magenta to green and the course pointer will move, or slew, to the final approach course as received from the external GPS navigator.

## TRIM AND FLAP POSITION INDICATORS (OPTIONAL)

Elevator Trim, Aileron Trim, Rudder Trim, and Flap Position indicators can be configured from the Engine/Airframe Input Configuration Page in Configuration Mode. Refer to the G3X Touch Installation Manual for more information.

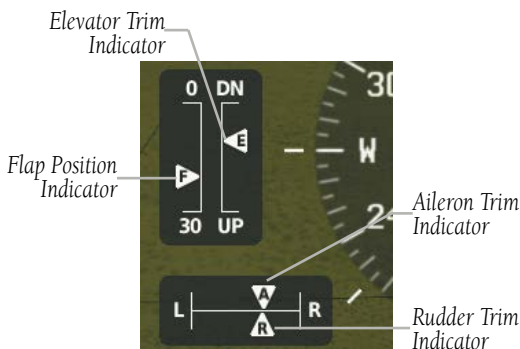

**Trim and Flap Position Indicators**

## TURN RATE INDICATOR

The Turn Rate Indicator is located above the HSI. Tick marks to the left and right of the displayed heading denote standard turn rates (3 deg/sec). A magenta Turn Rate Trend Vector shows the current turn rate. The end of the trend vector gives the heading predicted in 6 seconds, based on the present turn rate. A standard-rate turn is shown on the indicator by the trend vector stopping at the standard turn rate tick mark, corresponding to a predicted heading of 18° from the current heading. At rates greater than 4 deg/sec, an arrowhead appears at the end of the magenta trend vector and the prediction is no longer valid.





Turn Rate Indicator

## OBS MODE



**NOTE:** *If configured, the selected external GPS navigator (i.e., GTN or GNS Series Units) is used to set the OBS Mode.*

Enabling Omni-bearing Selector (OBS) Mode suspends the automatic sequencing of waypoints in a GPS flight plan, but retains the current “active-to” waypoint as the navigation reference even after passing the waypoint. ‘OBS’ is annunciated to the left of the aircraft symbol when OBS Mode is selected.

While OBS Mode is enabled, a course line is drawn through the “active-to” waypoint on the moving map. If desired, the course to/from the waypoint can now be adjusted. When OBS Mode is disabled, the GPS flight plan returns to normal operation with automatic sequencing of waypoints, following the course set in OBS Mode. The flight path on the moving map retains the modified course line.

**Enabling/disabling OBS Mode (without external GPS navigator):**

- 1) While navigating a flight plan or Direct-to, touch **CRS** on the PFD.
- 2) Touch **Yes** on the 'Set OBS and hold?' window.
- 3) Enter the desired course to/from the waypoint using the keypad and touch **Enter**.
- 4) To cancel OBS Mode and return to automatic waypoint sequencing, touch **OBS** on the PFD.
- 5) Touch **Release OBS Hold**.

**OR**

- 1) From the Active Flight Plan Page, press the **MENU** Key
- 2) Touch **Set OBS and Hold**.
- 3) Touch **Sync Course** or enter the desired course to/from the waypoint using the keypad and touch **Enter**.
- 4) To cancel OBS Mode and return to automatic waypoint sequencing, press the **MENU** Key.
- 5) Touch **Release Hold**.

**Enabling/disabling OBS Mode (with external GPS navigator configured):**

- 1) Press the **OBS** Key on the external navigator. The 'Set OBS and Hold' Active Flight Plan Page menu option is now available.
- 2) From the Active Flight Plan Page press the **MENU** Key while navigating a flight plan or Direct-to.
- 3) Touch **Set OBS and Hold**.
- 4) Touch **Sync Course** or enter the desired course to/from the waypoint using the keypad and touch **Enter**.
- 5) To cancel OBS Mode and return to automatic waypoint sequencing, press the **MENU** Key.
- 6) Touch **Release Hold**.

## 2.2 SUPPLEMENTAL FLIGHT DATA

In addition to the flight instruments, the PFD also displays various supplemental information, including the Outside Air Temperature (OAT), wind data, Angle of Attack, and Vertical Navigation (VNAV) indications.

### OUTSIDE AIR TEMPERATURE

The Outside Air Temperature (OAT) is displayed in degrees Fahrenheit (°F) or degrees Celsius (°C) on the PFD (GDU 45X) or on the PFD Status Bar (GDU 46X).

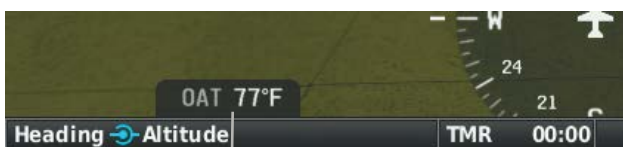

Outside Air Temperature

#### Outside Air Temperature on PFD (GDU 45X)



Outside Air Temperature

#### Outside Air Temperature on PFD Status Bar (GDU 46X)

### Changing the outside air temperature setting:

- 1) Press the **MENU** Key twice to display the Main Menu.
- 2) Touch **Setup > Units**.
- 3) Touch  in the **Air Temperature** field to display the Air Temperature options.
- 4) Touch (**Fahrenheit (°F)** or **Celsius (°C)**).

## WIND DATA

Wind direction/speed or headwind/Crosswind information can be displayed in a window to the upper left of the HSI. When the window is selected for display, but wind information is invalid or unavailable, the window displays "No Wind Data".

### Showing/hiding wind data:

- 1) From the full-screen PFD, press the **MENU** Key.
- 2) Touch **More Options**.
- 3) Touch  in the **Wind Vector** field to display the Air Temperature options.
- 4) Touch **Speed/Dir** or **Head/X-wind**.

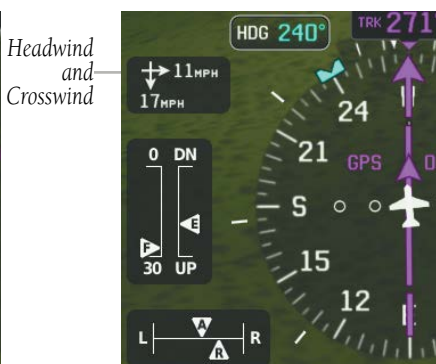
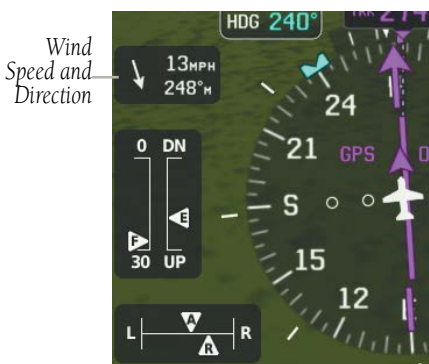

Wind Data

## USER TIMER

The G3X Touch provides a simple stopwatch for measuring arbitrary periods of time, separately from the Flight Timer. The User Timer can be accessed from the Main Menu and will appear at the Status Bar, labelled 'TMR'. Additionally, the User Timer can be optionally configured to appear in the Data Bar at the top of all screens.

### Using the User Timer:

- 1) From any screen, press the **MENU** key twice.
  - 2) Touch **User Timer**.
- OR:** Touch the **TMR** field, if present, in the Status Bar at the bottom of the display.
- OR:** Touch the **Timer** field, if present, in the Data Bar at the top of the display.

Touch **Start** to start the Timer. While the Timer is running, the Start button becomes a **Stop** button which pauses the Timer. **Reset** will set the Timer to zero and stop the Timer. Pressing the **Back** Key to close the User Timer box will not interrupt the Timer.



User Timer



User Timer on Status Bar

### Adding User Timer to Data Bar:

- 1) From any screen, press the **MENU** key twice.
- 2) Touch **Setup**.
- 3) Touch **Data Bar**.
- 4) Find User Timer Button in the list. Touch the combo box to set the User Timer to **Show On Left**, **Show On Right**, or **Hide**.
- 5) Touch the **Timer** button on the Data Bar to access the User Timer dialog box.



User Timer on Data Bar

## ANGLE OF ATTACK (AOA)

For G3X Touch installations that include a GAP 26 and a GSU 25, Angle of Attack information can be displayed on the PFD. Refer to the G3X Touch Installation Manual for the Angle of Attack Calibration procedure. During Angle of Attack Calibration Stall Warning AOA, Caution Alert AOA, Minimum Visible AOA, and Approach Target AOA settings are defined.

When AOA exceeds the calibrated Caution Alert threshold (AOA gauge), an intermittent audible tone will be heard. The tone will increase in frequency until the Stall Warning AOA, when it will play continuously.

When AOA is below the calibrated Minimum Visible AOA threshold, the angle of attack gauge is not displayed.

When the GAP 26 and GSU 25 are paired with the GI 260 AOA Indicator, the Angle of Attack information can be displayed on the glare shield within the Pilot's view.

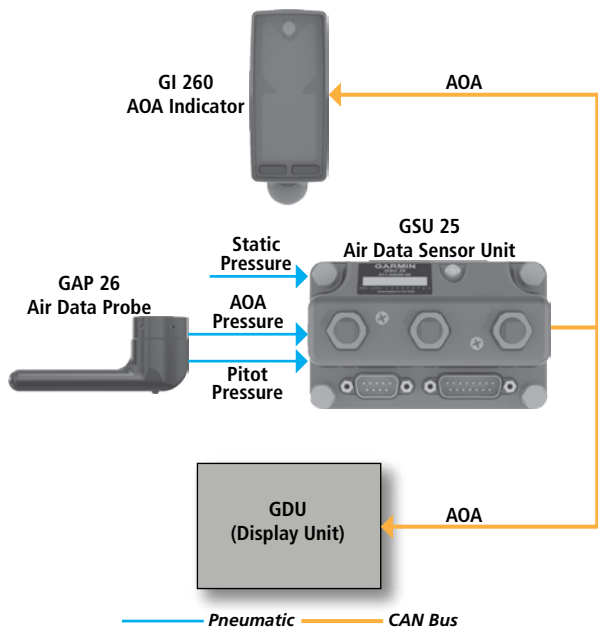

## Angle of Attack (AOA) System

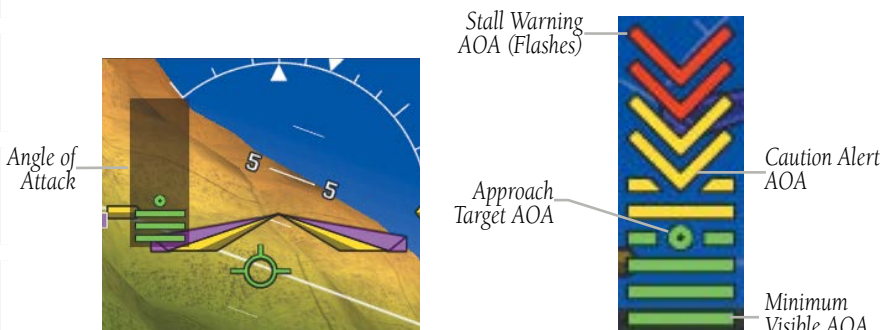

Angle of Attack (AOA)

Angle of Attack Display (AOA)

## 2.3 VERTICAL NAVIGATION (VNAV)



**CAUTION:** VNAV is only a VFR navigation aid and is not intended for instrument approaches.

The Vertical Navigation Page provides settings for the vertical navigation feature. These settings create a three-dimensional profile from the present location and altitude to a final (target) altitude at a specified location.

When the VNAV profile is defined, the pilot is informed of the progress by message alerts. A magenta chevron (VNAV Indicator) to the left of the altimeter on the Vertical Deviation Scale shows the VNAV profile, and a magenta chevron (Required Vertical Speed Indicator (RVSI)) on the Vertical Speed Indicator indicates the required vertical speed to reach the target altitude.

The Vertical Navigation feature is only available when navigating a Direct-to or flight plan, and the ground speed is greater than 35 knots.



**NOTE:** The Vertical Navigation feature is not available when using the VNAV autopilot in HDG mode.

One minute prior to the initial descent point the “Approaching VNAV Profile” message appears and the ‘Estimated Time to VNAV’ (on Active Flight Plan Page) goes blank. The descent angle locks to prevent changes in speed from altering the profile. The VNAV feature does not take into account any changes in ground speed that occur during the transition from level flight to descent.

**Approaching VNAV profile**

At 200 ft above the target altitude, the “Approaching Target Altitude” message appears, and the VNAV indicator disappears from the PFD.

**Approaching VNAV target altitude**

System Overview

Flight Instruments

EIS

CNS Interface

GPS Navigation

Flight Planning

Hazard Avoidance

Additional Features

AFCs

Annun/Alerts

Appendix

Index

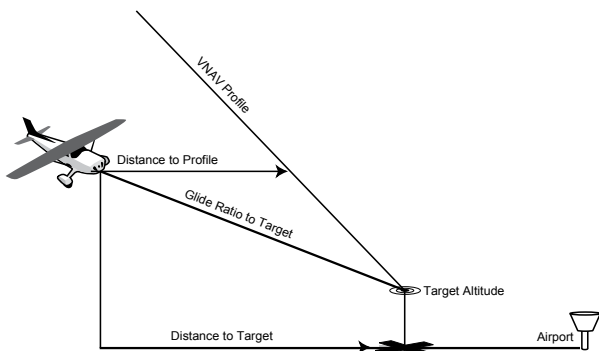

Visual Representation of VNAV

## USING THE VNAV FEATURE

Use the VNAV (Vertical Navigation) feature to ensure the aircraft is at the proper altitude. The magenta VNAV Indicator appears on the PFD. A message appears when approaching the VNAV Profile. When the VNAV Indicator is in the vertical center of the Vertical Deviation Scale, the aircraft is at the proper altitude for the VNAV Profile.

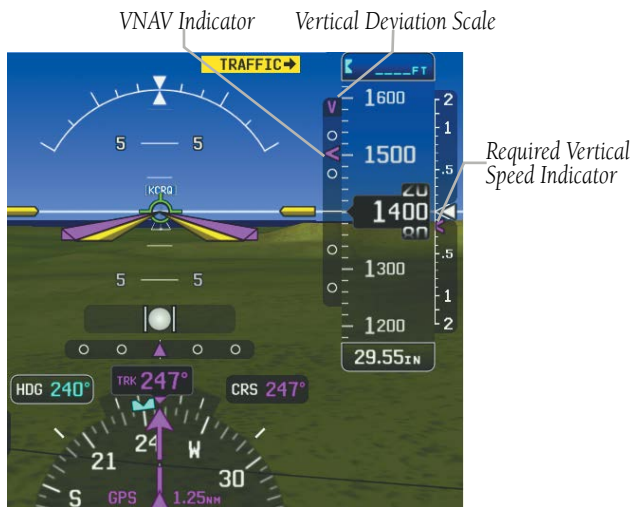

VNAV Indications (PFD)



## Configuring a VNAV profile:

- 1) Press the **MENU** Key twice.
- 2) Touch **VNAV**.
- 3) Touch the **Waypoint** field and choose the desired VNAV waypoint.
- 4) Touch the **Profile** value.
- 5) Enter the desired descent rate in fpm using the keypad and touch **Enter**.
- 6) Touch the **Altitude** value.
- 7) Enter the desired altitude using the keypad and touch **Enter**.
- 8) Touch **Above WPT** or **MSL**.
- 9) Touch the **By** value.
- 10) Enter the desired miles using the keypad and touch **Enter**.
- 11) Touch **Before** or **After**.
- 12) Touch **On** or **Off** to enable or disable VNAV Messages.
  - Waypoint—Enter any waypoint along the currently active route as the reference waypoint. The reference waypoint defines the target location.
  - Profile—Enter the descent rate.
  - Altitude—Enter the desired reference waypoint altitude. Select 'Above Waypoint' to use field elevation for airports in the navigation database or 'MSL' to specify an exact MSL altitude target.



**NOTE:** *Some waypoints such as intersections do not have an altitude in the database and thus only the VNAV altitude in MSL (not Above Waypoint) may be specified for these waypoints.*

- **By**—Enter the target location with settings of distance 'Before' or 'After' a reference waypoint. To set a target location at a reference waypoint, enter a distance of zero.
- **VNAV Messages**—Select 'On' or 'Off' to enable/disable VNAV alert messages.

### Forcing capture of the VNAV profile:

- 1) While navigating a flight plan or Direct-to, press the **MENU** Key twice.
- 2) Touch **VNAV** and enter a valid VNAV profile and begin navigation.
- 3) From the Vertical Navigation Page, press the **MENU** Key.
- 4) Touch **Capture VNAV Profile**. Selecting **Capture VNAV Profile** centers the VNAV indicator.

### Canceling the VNAV profile:

- 1) While navigating a flight plan or Direct-to with a valid VNAV profile, press the **MENU** Key twice.
- 2) Touch **VNAV**.
- 3) Press the **MENU** Key.
- 4) Touch **Cancel VNAV Profile**.

## SECTION 3 ENGINE INDICATION SYSTEM

### 3.1 EIS DISPLAY & ENG PAGE



**NOTE:** The display of the G3X Touch Engine Indication System depends upon the current configuration and may vary from the examples discussed in this section.

The G3X Touch EIS displays critical engine, electrical, and other system parameters. Additional EIS information can be viewed by selecting the **Eng** Page on the MFD.

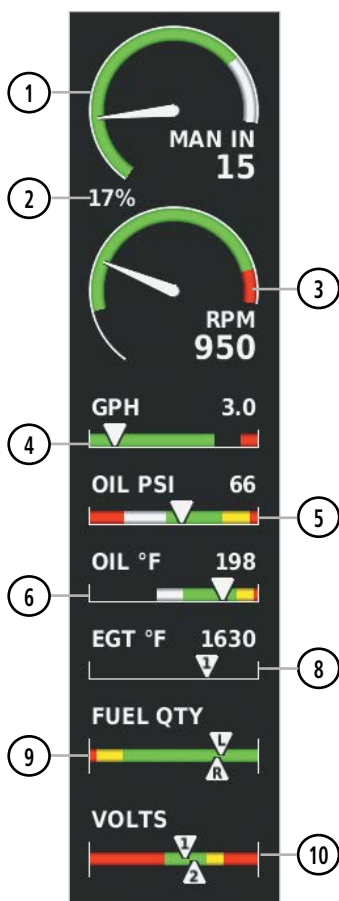

Example Engine Indication System (PFD)



Example Main Tab on the Eng Page



Example Fuel Calculator Tab on the Eng Page

Green bands on the instruments indicate normal ranges of operation; yellow and red bands indicate caution and warning, respectively. When unsafe operating conditions occur, the corresponding caution readout will display solid yellow and the warning readout will flash red. If sensory data to an instrument becomes invalid or unavailable, a red "X" is displayed across the instrument.

<b>1</b>	<b>Engine Manifold Pressure</b>	Displays manifold pressure to indicate engine power
<b>2</b>	<b>Engine Power</b>	Estimated engine power output expressed as a percentage
<b>3</b>	<b>Tachometer (RPM)</b>	Displays propeller speed in revolutions per minute (rpm)
<b>4</b>	<b>Fuel Flow</b>	Displays fuel flow.
<b>5</b>	<b>Oil Pressure</b>	Displays oil pressure
<b>6</b>	<b>Oil Temperature</b>	Displays oil temperature
<b>7</b>	<b>Cylinder Head Temperature</b>	Displays the head temperature of the hottest cylinder
<b>8</b>	<b>Exhaust Gas Temperature</b>	Displays the Exhaust Gas Temperature
<b>9</b>	<b>Fuel Quantity</b>	Displays the amount of fuel in each tank
<b>10</b>	<b>Voltmeter</b>	Displays the main bus voltage
<b>11</b>	<b>Fuel Pressure</b>	Displays fuel pressure
<b>12</b>	<b>Lean Assist</b>	Activates/deactivates Lean Assist (optional)
<b>13</b>	<b>Engine Hours (Tach)</b>	Counted whenever a valid RPM is detected.
<b>14</b>	<b>Ammeter</b>	Displays the main bus amps.
<b>15</b>	<b>Total Hours</b>	Refer to the G3X Touch Installation Manual.
<b>16</b>	<b>Fuel Calculator</b>	Calculates fuel endurance, range, and economy

Engine Power will display as a percentage for most typical Lycoming/Continental style engines.

For the Lycoming iE2 FADEC engine, the Engine Power indication can additionally show "PFT" while the FADEC is performing a pre-flight test.

For the Rotax 912iS FADEC engine, the Engine Power indication doesn't show a percentage. Instead this indication has one of two functions. If the FADEC is operating in economy mode, the Engine Power indication shows "ECO." Alternatively, while the aircraft is on ground and the engine is not running, the Engine Power indication instead shows the throttle position, noted as a two-digit value preceded by a "T", such as "T10" for 10% throttle. This is used for the aircraft's pre-flight checklist. Otherwise, the Engine Power indication will be blank.

## 3.2 MULTI-ENGINE INDICATIONS (OPTIONAL)

### PROPELLER SYNC INDICATOR

In Multi-Engine installations, a Propeller Sync Indicator is displayed on the Tachometer. The indicator spins in the direction of the higher-speed propeller when the propellers are out of sync.

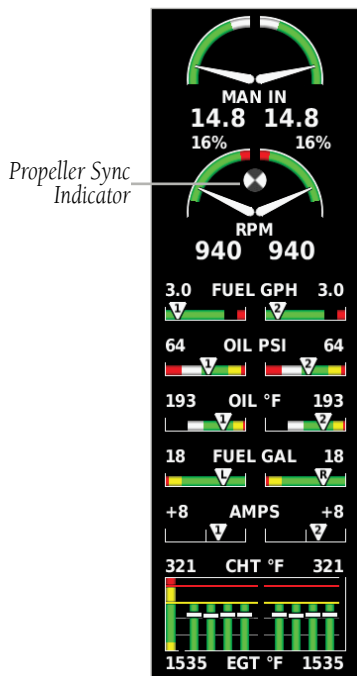

Example Engine Indication System (PFID)  
(Multi-Engine)

Propeller Sync Indicator

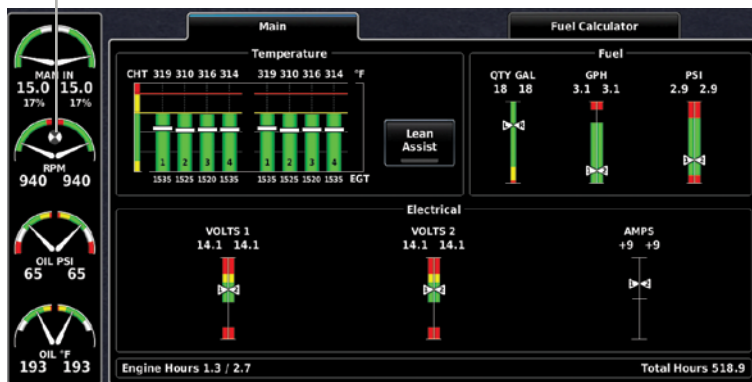

Example Main Tab on the Eng Page (Multi-Engine)

### 3.3 LEAN ASSIST MODE (OPTIONAL)



**NOTE:** The pilot should follow the engine manufacturer’s recommended leaning procedures as described in the Pilot’s Operating Handbook (POH).

A **Lean Assist** Button is displayed on the **Main** Tab of the Eng Page when Lean Assist Mode is enabled and at least one Exhaust Gas Temperature (EGT) or Turbine Inlet Temperature (TIT) input is configured (refer to the G3X Touch Installation Manual for more information).

#### Using Lean Assist Mode:

From the **Main** Tab of the Eng Page, touch **Lean Assist**. As the mixture is leaned, one of the cylinders’ exhaust temperature will peak. Continuing to lean the mixture will cause each additional cylinder to peak (if applicable) until the last of the cylinders peaks. To cancel Lean Assist Mode, touch **Lean Assist** again.

When the **Lean Assist** is selected, the Lean Assist Mode waits for a cylinder’s EGT to reach a peak temperature and decrease by at least 7°F. To prevent detection of false peaks, the system waits for a cylinder’s EGT to increase by at least 15°F before detecting a peak. In addition, if the cylinder temperature rises above a previously detected peak by more than 100°F, the previous peak is considered false.

The following bar graph is displayed when 4 or more EGT cylinders are configured and the same number of EGT and CHT probes are configured. When each cylinder peaks, its bar changes from green to blue, and the white EGT number changes to a blue delta number. The blue delta number is the difference between current EGT and peak EGT for each cylinder. The first cylinder to peak is identified with a solid blue box around the delta number, and the last cylinder to peak is identified with a hollow blue box. The outline and grey number above each bar displays the actual peak EGT value.

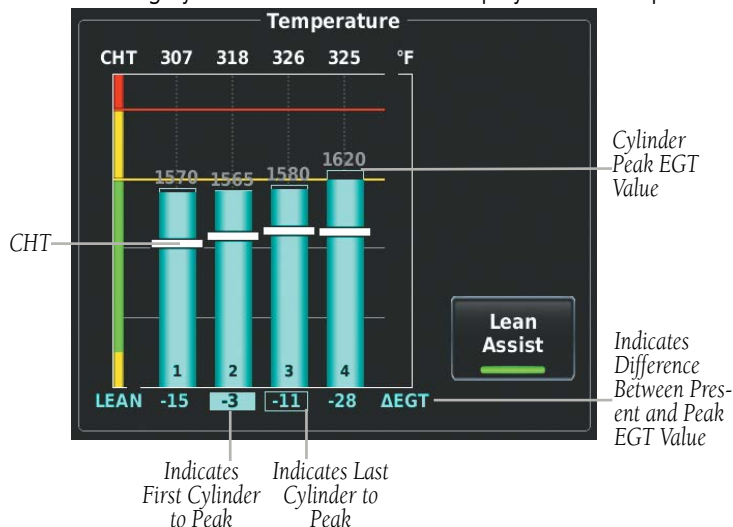

### Lean Assist (Same Number Of EGT And CHT Probes Configured And 4 Or More Cylinders Configured)



The following graph is displayed if EGT data is configured on less than 4 cylinders and a different number of EGT and CHT probes are configured. The temperature deviation between the current temperature and the peak temperature for the cylinder currently closest to its peak is displayed in light blue. A light blue hollow triangle appears on the EGT gauge at the temperature where the first cylinder peaked.

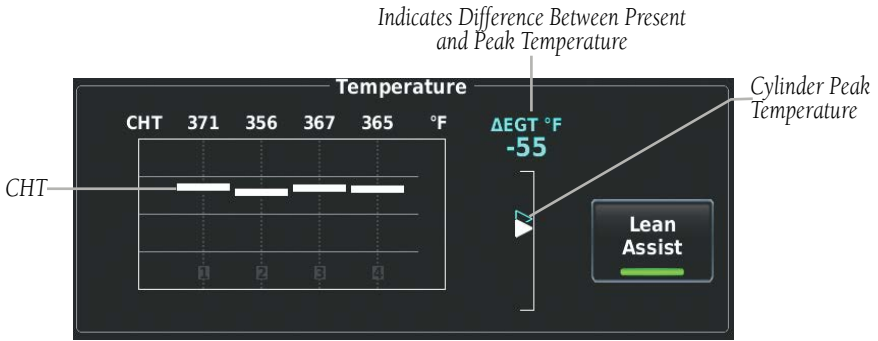

**Lean Assist (Different Number Of EGT And CHT Probes Configured And Less Than 4 Cylinders Configured)**

The following dual-pointer gauge is displayed when exactly two cylinders of EGT are configured. Each cylinder has its own peak temperature triangle.

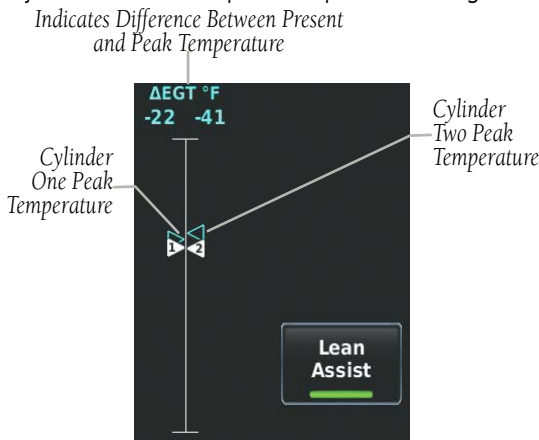

**Lean Assist (Two EGT Cylinders Configured)**

- System Overview
- Flight Instruments
- EIS**
- CNS Interface
- GPS Navigation
- Flight Planning
- Hazard Avoidance
- Additional Features
- AFCs
- Annun/Alerts
- Appendix
- Index

The following gauge is displayed when TIT is configured instead of EGT.

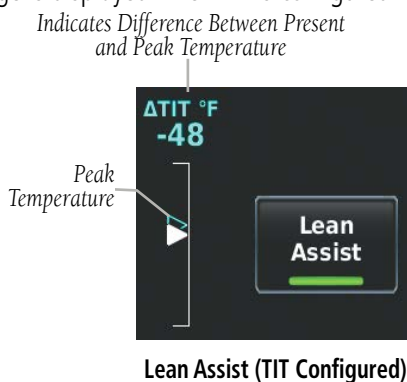

**NOTE:** A '+' ( $\Delta EGT$ ) value indicates that the current temperature is greater than the previously detected peak.

If a fuel flow sensor is configured, the fuel flow value detected as the first cylinder peaks is saved. The fuel flow corresponding to peak EGT is drawn on the fuel flow gauge as a hollow blue pointer. This can be used to determine if you are on the rich side of peak (ROP) or the lean side of peak (LOP). Rich of Peak (ROP) if the fuel flow pointer is above the blue triangle, or Lean of Peak (LOP) if the fuel flow pointer is below the blue triangle.

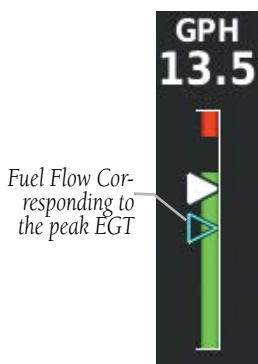

Fuel Flow Gauge - Lean Assist  
(Fuel Flow Sensor Configured)

The EIS displays the cylinder whose temperature is currently closest to its own peak value (when Lean Assist Mode is active) as a white pointer with the cylinder number. The peak temperature is depicted by a hollow blue pointer, and the temperature deviation from peak ( $\Delta$ EGT or  $\Delta$ TIT) is displayed in place of the normal temperature number in light blue text.

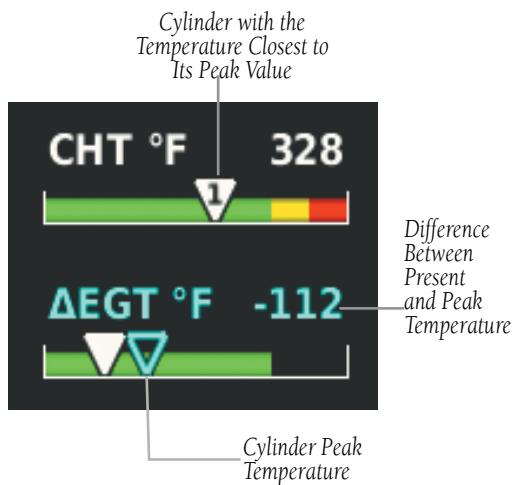

Lean Assist (EIS)

## 3.4 FUEL CALCULATOR (OPTIONAL)



**WARNING:** The G3X Touch Fuel Calculator and/or Fuel Range Rings are NOT intended to be relied upon as the primary fuel indicator(s), and does not relieve the pilot from the responsibility of proper flight planning. G3X Touch fuel calculations do not use the aircraft fuel quantity indicators and are calculated from the last time the fuel was reset.

Refer to the Section 5.2, Using Map Displays, for information on displaying fuel range rings on the Navigation Map.

### Adjusting the Fuel Remaining or Fuel Used quantity:

- 1) From the ENG Page, touch the **Fuel Calculator** Tab.
- 2) Touch '+' or '-' to adjust the desired quantity.

**Or:**

Touch the value to enter the fuel quantity using the keypad and touch **Enter**.

### Resetting the Fuel Used to zero:

- 1) From the ENG Page, touch the **Fuel Calculator** Tab.
- 2) Touch **Reset**.



Fuel Calculator

## 3.5 CAS MESSAGES (OPTIONAL)

The Crew Alerting System (CAS) messages displayed depend upon the current configuration, and will vary from the examples listed below. Refer to the G3X Touch Installation Manual for more information on configuring CAS messages (if applicable).

CAS Messages are grouped by criticality (warning, caution, advisory). The color of the message is based on its urgency and on required action:

- **WARNING (red):** Requires immediate attention.
- **CAUTION (yellow):** Requires pilot awareness and possible future corrective action.
- **ADVISORY (white):** Provides general information.

Warning annunciation text is shown in red in the CAS Annunciation Window on the PFD. The CAS Annunciation Window is located to the right of the Horizontal Situation Indicator. Touch an active CAS message to acknowledge it.



CAS Warning Example

- System Overview
- Flight Instruments
- EIS**
- CNS Interface
- GPS Navigation
- Flight Planning
- Hazard Avoidance
- Additional Features
- AFCS
- Annun/Alerts
- Appendix
- Index

Blank Page

## SECTION 4 CNS INTERFACE

### 4.1 CNS INTERFACE

The Communication/Navigation/Surveillance (CNS) system includes the audio interface, communication radios, navigation radios, and Mode S transponder. These functions can be accessed from the boxes that make up the CNS Data Bar located at the top of the PFD and/or MFD.



CNS Data Bar

- ① COM1 - Transfers the standby and active COM1 frequencies.
- ② STBY - Displays/removes the COM1 Standby Page. The COM1 Standby Page is used to enter and transfer COM1 frequencies.
- ③ Audio - Displays/removes the Audio/Intercom Page. The Audio/Intercom Page is used to select GMA 245/245R functions
- ④ MIC - Used to toggle between Mic 1 and Mic 2 inputs (also toggles Com 1/Com 2)
- ⑤ COM - Used to select/deselect a monitored radio
- ⑥ XPDR - Displays/removes the Transponder Page. The Transponder Page is used to select Transponder functions
- ⑦ IDENT - Initiates the transponder Ident function
- ⑧ Configurable Data Field - WPT (example)- See Appendix A for complete list of options
- ⑨ Configurable Data Field - BRG (example)- See Appendix A for complete list of options
- ⑩ COM 2 - Transfers the standby and active COM2 frequencies.
- ⑪ STBY - Displays/removes the COM2 Standby Page. The COM2 Standby Page is used to enter and transfer COM2 frequencies.

## 4.2 AUTO-TUNING FREQUENCIES (OPTIONAL)



**NOTE:** Refer to the G3X Touch Installation Manual for more information on the G3X Touch optional communication interfaces.

Frequencies can be automatically tuned from the following:

- Map Page
- Weather Page
- Waypoint Page
- Nearest Airports Page
- Nearest Airport Weather Page
- Nearest VOR Page
- Nearest Airspace Page

### Auto-tuning a frequency:

- 1) Touch the page navigation bar on the MFD.
- 2) Touch **Waypoint**.
- 3) Touch the waypoint identifier field at the top of the page.
- 4) Enter the desired waypoint and touch **Enter**.
- 5) Touch **Freq**.
- 6) Touch the desired frequency to tune.
- 7) OPTIONAL: Touch the desired COM radio if configured with more than one.

**Or:**

- 1) Touch the page navigation bar on the MFD
- 2) Touch **Map** or **SXM Weather**.
- 3) Touch the desired waypoint or airport on the map.
- 4) Touch the selected waypoint identifier name below the map.
- 5) Touch **Freq**.
- 6) Touch the desired frequency to tune.
- 7) OPTIONAL: Touch the desired COM radio if configured with more than one.

**Or:**



- 1) Press the **NRST** Key.
- 2) Touch the page navigation bar.
- 3) Touch **Airports** or **Airport WX**.
- 4) Touch the desired airport.
- 5) Touch **Freq**.
- 6) Touch the desired frequency to tune.
- 7) OPTIONAL: Touch the desired COM radio if configured with more than one.

**Or:**

- 1) Press the **NRST** Key.
- 2) Touch the page navigation bar.
- 3) Touch **VORs**.
- 4) Touch the desired VOR.
- 5) Touch the frequency button.

**Or:**

- 1) Press the **NRST** Key.
- 2) Touch the page navigation bar.
- 3) Touch **Airspace**.
- 4) Touch the desired airspace.
- 5) Touch **Frequencies**.
- 6) Touch the desired frequency to tune.
- 7) OPTIONAL: Touch the desired COM radio if configured with more than one.

### 4.3 COM RADIO (OPTIONAL)

The COM Frequency Box is composed of two fields; one active frequency is on the left side and the standby frequency is on the right side.

When an audio panel is configured, an active COM frequency displayed in green indicates that the COM transceiver is selected. If an audio panel is not configured in the system, all COM active frequencies are always displayed in green (since the GDU has no knowledge which radio(s) are selected).

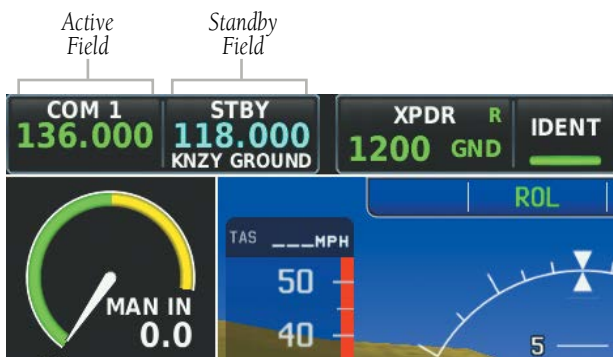

COM Radio on PFD



COM Radio

### Manually tuning a COM frequency:

- 1) Touch STBY on CNS Audio Bar.
- 2) Enter the frequency using the keypad and touch Enter.  
**Or:**
  - a) Touch Find.
  - b) Touch the Recent, Nearest Airports, Flight Plan, or User Waypoint Tab.
  - c) Touch the frequency or touch Select Frequency....**Or:**
  - a) Touch Find.
  - b) Touch Select an Airport.
  - c) Enter the four letter ICAO identifier for the desired airport.
  - d) Touch the desired frequency.
- 3) Touch the COM1 Frequency Field to transfer the frequency to the Active Field.

### Adjusting COM Volume:

- 1) Touch STBY on CNS Audio Bar.
- 2) Touch Volume.
- 3) Touch the slider to adjust the percentage.

### Monitoring the Standby COM:

- 1) Touch STBY on CNS Audio Bar.
- 2) Touch Monitor. A green MON is displayed in the Standby Field.

### Transferring Standby to Active:

From the CNS Audio Bar, touch the COM 1 frequency field.

## COM RADIO VOLUME SHORTCUT

The Data Bar Setup page can enable a COM Radio Volume Short panel that appears while a COM panel is active. This shortcut panel displays touchscreen controls for volume and toggle on/off squelch for the currently displayed COM radio. The shortcut panel appears on the opposite side of the screen as the COM panel.



COM Radio Volume Level and Squelch Button

COM Radio Volume Shortcut

## AUTOMATIC SQUELCH

Automatic Squelch quiets unwanted static noise when no audio signal is received, while still providing good sensitivity to weak COM signals. To disable Automatic Squelch, touch **STBY** > **Squelch**. When Automatic Squelch is disabled, COM audio reception is always on. Continuous static noise is heard over the headsets and speaker, if selected. Touching **STBY** > **Squelch** again enables Automatic Squelch.

When Automatic Squelch is disabled, a green SQ appears next to the COM frequency.

## 4.4 GMA 245/245R (OPTIONAL)



**NOTE:** The audio panel information in this section pertains only to G3X systems configured with a GMA 245/245R. Screenshots and descriptions may differ from actual display function depending upon configuration.

When configured with a GMA 245/245R audio panel, touching the Audio Box on the CNS Data Bar will display the Audio/Intercom Page. The Audio/Intercom Page allows selection of four separate tabs, these are the Radios, Intercom, Phone & Media, and Music Input tabs. The Audio Box can be configured for Normal or Minimized display format, (Audio Only format may be displayed as determined by available space on the CNS Data Bar).

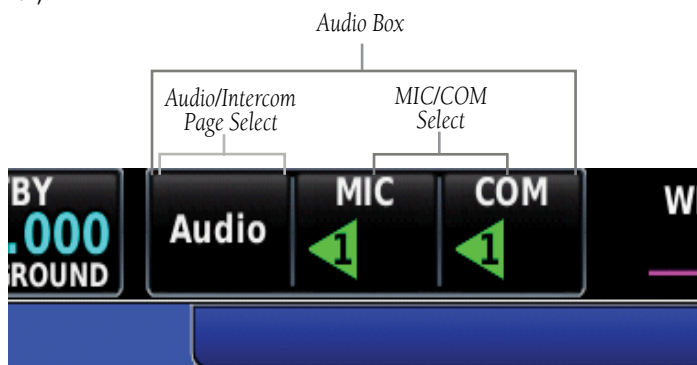

Audio Box on CNS Data Bar

There are three different formats of the Audio Box that may be displayed:

Audio Box Format	Description
	Normal - Provides access to the Audio/Intercom Page and MIC/COM settings.
	Minimized - Provides access to the Audio/Intercom Page and displays the current MIC/COM settings (cannot change the MIC/COM settings in this format)
	Audio Only - Provides access to the Audio/Intercom Page. Displayed only when not enough room for the Minimized control to be displayed (not user selectable):

The preceding examples all indicate that no Bluetooth phone call is in progress. When a phone call is incoming or in progress, a “TEL” indicator is displayed (flashing to indicate incoming call, non-flashing to indicate call is active), see Phone & Media Tab section for more information. Note that the Audio Box can be configured to display square or triangle indicators.



Several status indications can be selected/shown in the Audio Box per the following table.

Audio Box (Normal)	Description
	MIC 1 selected, monitoring COM 1
	MIC 2 selected, monitoring COM 2
	MIC 1 selected, monitoring COM 1 and COM 2
	MIC 2 selected, monitoring COM 1 and COM 2
	Split COM selected. Isolates the COM 1 radio to the pilot and the COM 2 radio to the copilot.

### Selecting the Monitored Radio:

Touch **COM** on the CNS Data Bar to select/deselect a monitored radio.

### Selecting the Radio to transmit from:

Touch the **MIC** box on the CNS Data Bar to select/deselect the radio used to transmit (talk) from.

### Selecting/Deselecting Split COM mode:

- 1) Touch **Audio** on the CNS Data Bar to display the Audio/Intercom Page.
- 2) Touch the **Radios** tab if needed.
- 3) Touch the **Split COM** button to select (green) or deselect Split COM mode.

## AUDIO/INTERCOM PAGE

### Selecting Audio/Intercom Page

Touch **Audio** on the CNS Data Bar.

## RADIOS TAB

The following paragraphs describe the functions accessible from the Radios Tab.

### Selecting the Radios tab:

- 1) Touch **Audio** on the CNS Data Bar.
- 2) Touch the **Radios** tab (if needed.)

**Or:**

- 1) Press the **MENU** Key twice.
- 2) Touch the **Audio Panel** button to display the Audio/Intercom Page.
- 3) Touch the **Radios** tab (if needed.)



Audio/Intercom Page, Radios Tab

## COM RADIOS

The COM 1/COM 2 buttons select the monitored radio. The COM 1 MIC/COM 2 MIC buttons selects the radio used to transmit from.

Selecting "Split COM" overrides the current MIC/COM selections and enables MIC1/COM1 for the pilot, and MIC2/COM2 for the copilot (i.e., "Split COM" isolates the COM 1 radio to the pilot and the COM 2 radio to the copilot).

## NAV RADIOS

The NAV Radios section allows selection of NAV 1 and NAV 2 functions.

## SPEAKER

The Speaker function enables audio to be played through a connected speaker. Alert audio is always played over the speaker, regardless of the speaker button state.

## PLAY BUTTON

This button is used to play back the last received radio transmission(s), and is not associated with audio/video.

- The playback recording is only for the mic selected radio.
- Pressing the play button again while a recording is playing skips that recording and starts playing the previous recording. After repeatedly pressing this button until all recordings have been played, a double-beep will sound and the playback will reset to the start. The playback function also resets to the start after listening to a selected recording.
- The playback function retains approximately the last 60 seconds of received audio from the MIC selected COM radio.



Pilot and  
Copilot  
Intercom  
Volume Levels



Audio Intercom Volume Shortcut Panel

## MORE OPTIONS

The More Options button allows access to the AUX 1, AUX 2, AUX 3, and Active COM Receive Monitor Mute functions. Selecting Monitor Mute, mutes the monitored COM radio when audio from the MIC selected COM radio is heard.



Radios Tab, More Options Button Selected

## INTERCOM TAB

The following paragraphs describe the functions accessible from the Intercom Tab.

### Selecting the Intercom tab:

- 1) Touch **Audio** on the CNS Data Bar.
- 2) Touch the **Intercom** tab (if needed.)

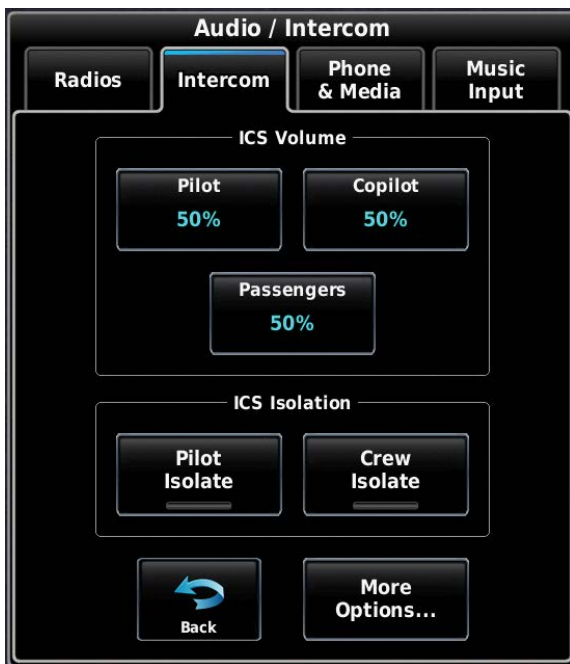

Audio/Intercom Page, Intercom Tab

## ICS VOLUME

The ICS Volume section allows selection of Pilot, Copilot, and Passenger intercom volume. A volume adjust slider is used to set the selected volume on G3X Touch systems with a GMA 245R. Intercom volume controls are not present on G3X Touch systems with a GMA 245, intercom volume is controlled using the knobs on the GMA 245 instead.

### Adjusting Volume:

- 1) Touch **Pilot, Copilot, or Passengers** on Intercom Tab.
- 2) Touch the slider to adjust the percentage.

## ICS ISOLATION

The ICS Isolation section allows selection of Pilot and Crew Isolate functions. These functions are annunciated in the Audio Box on the CNS Data Bar when active.

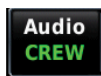
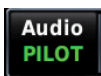

Pilot Isolation mode isolates the Pilot from other ICS positions (Copilot and Passengers). The Copilot and Passengers share communication between themselves but cannot communicate with the Pilot or hear the pilot's selected radios.

Crew Isolation mode places the Pilot and Copilot on a common ICS communication channel. The Passengers are on their own intercom channel and can communicate with each other, but cannot communicate with the Pilot and Copilot or hear the pilot's selected radios.

## MORE OPTIONS...

The More Options button allows access to the 3D Audio and Muting functions.



Intercom Tab, More Options Button Selected

## 3D AUDIO

3D Audio is useful when multiple audio sources are present. 3D audio processing creates the illusion that each audio source is coming from a unique location or seat position by using different responses in each ear. Because this feature uses different signals for left and right channels, it requires wiring for stereo intercom and stereo headsets. If 3D audio is activated when mono headsets are in use, the listener will still hear all audio sources; however, there is no benefit from location separation. With a single COM selected and Radio 3D Audio enabled, the listener hears the audio source at the 12 o'clock position. If both COMs are selected, the listener hears COM1 at 11 o'clock and COM2 at the 1 o'clock position. When ICS 3D Audio is selected, all intercom positions are processed to sound like their relative seat location. By default, the GMA 245/245R assumes the pilot sits in the left seat.

### Selecting Radio/ICS 3D Audio:

- 1) Touch **More Options** button on the Intercom tab.
- 2) Touch the **Radio 3D Audio** or **ICS 3D Audio** button to select/deselect the desired 3D Audio function.

## MUTING

- Radio Mutes ICS – When Radio Mutes ICS is enabled, intercom audio from passengers to crew is muted when audio from the COM selected for transmission is heard.
- Radio Mutes Music – When Radio Mutes Music is enabled, music audio is muted when radio audio is heard.
- ICS Mutes Music – When ICS Mutes Music is enabled, music audio is muted when intercom audio is heard.

## VOLUME SHORTCUT

The Data Bar Setup page can enable a Volume Shortcut panel that appears while the Audio/Intercom panel is active. This shortcut panel displays touchscreen volume controls for pilot and copilot intercom, music, and Bluetooth audio. When a tab in the Audio/Intercom panel is selected, the Volume Shortcut panel changes to the volume controls for that source - i.e., when the Phone & Media tab is selected, the Volume Shortcut panel adjusts the volume for the Bluetooth audio. The shortcut panel's source can also be changed by pressing either of the knobs. The shortcut panel appears on the opposite side of the screen as the Audio/Intercom panel.

## PHONE & MEDIA TAB

### Selecting the Phone & Media tab:

- 1) Touch **Audio** on the CNS Data Bar.
- 2) Touch the **Phone & Media** tab (if needed.)

The Phone & Media Tab on the Audio-Intercom Page, provides access to the telephone controls, enables media playback, and connects to a Bluetooth device.



Audio/Intercom Page, Phone & Media Tab

## MEDIA

The Media Controls enable playback of the current media (i.e., music, movie, etc..). The buttons are grayed out when media is unavailable.



Media Controls

## BLUETOOTH

The Bluetooth “Pair Device” button with a toggle indicates when the “pairing mode” is currently active. Pressing this button initiates the pairing operation and indicates when pairing is in progress. The toggle is displayed as green until the GMA reports that pairing mode is no longer active. When pairing is not allowed, pressing this button performs no action.

When pairing mode is enabled, the GMA 245/245R is able to be paired to other Bluetooth enabled devices. Refer to the device's user manual for instructions on how to pair to a Bluetooth device. The GMA 245/245R will remember the ten most recently paired devices, if the list is full and a new device is paired, the device with the oldest connection date/time is removed from the list.

The GMA 245 supports Bluetooth wireless delivery of pilot headphone audio to versions of the Garmin VIRB action camera that support Bluetooth mic audio input for recording.

Pairing a Garmin VIRB to the GMA 245 works like pairing other Bluetooth audio devices. Once connected, pilot headphone audio will be delivered to the VIRB via Bluetooth. In a connection to the Garmin VIRB, the GMA is the source. Therefore, selecting an entertainment key is not required.

### BLUETOOTH CONNECTION STATUS

The Bluetooth connection status is either displayed with a single checkbox for “No Connection”, or with 1 or 2 checkboxes for each item connected (i.e., a single checkbox for media only, phone only, and output only, or 2 checkboxes for media and phone, or media and output).

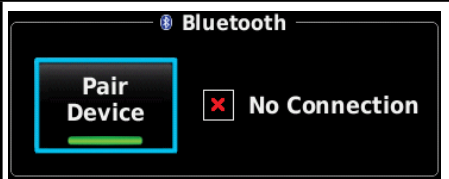
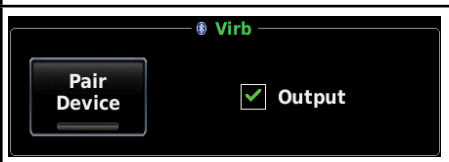
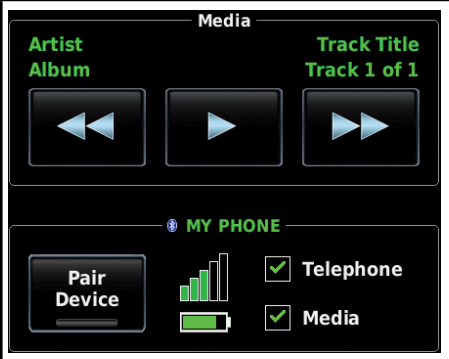
Bluetooth/Media Indication	Description
	<p>No Bluetooth connection, pairing mode disabled.</p>
	<p>No Bluetooth connection, pairing mode enabled.</p>
	<p>Bluetooth is connected with a Virb Action camera that supports Bluetooth audio.</p>
	<p>Bluetooth is connected with telephone and media functions. When connected to the telephone, the Bluetooth title is replaced with the phone's ID (if provided by phone).</p>

- System Overview
- Flight Instruments
- EIS
- CNS Interface
- GPS Navigation
- Flight Planning
- Hazard Avoidance
- Additional Features
- AFCs
- Annun/Alerts
- Appendix
- Index

Bluetooth/Media Indication	Description
	<p>Bluetooth is connected with telephone function only.</p>
	<p>Bluetooth is connected with media functions only.</p>
	<p>Bluetooth is connected with media, but the connected device does not support media controls. In this instance, the media controls are disabled. The audio is audible via the intercom but may only be controlled via the external device.</p>

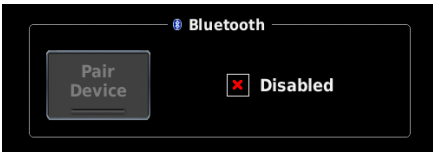

Bluetooth/Media Indication	Description
	<p>When the audio is playing with the media controls enabled, the Play button is replaced with the Pause button.</p> <p>If provided by the external device, the album/artist/title/track number is displayed above the media controls. The external device may provide all, none, or only a part of this information.</p>
	<p>Bluetooth interface is disabled. The GMA's Bluetooth interface may be enabled/disabled as described below.</p>

### DISABLING BLUETOOTH ON GMA 245R

To aid in troubleshooting, the G3X Touch can be used to disable the Bluetooth functionality on the GMA 245R devices. Bluetooth on the GMA 245R can be re-enabled with the same process as disabling it. The GMA 245R will also re-enable Bluetooth when it is powercycled. GMA 245 devices have physical controls to perform this procedure as well, refer to the GMA 245 Pilot's Guide.

#### Disabling and Enabling GMA 245R Bluetooth:

- 1) Press the **MENU** Key twice.
- 2) Touch the **Audio Panel** button to display the Audio/Intercom Page.
- 3) Touch the **Phone & Media** tab.
- 4) Press the **MENU** Key.
- 5) Touch **Disable/Enable**.



### TELEPHONE OPERATIONS

When the Bluetooth connection status indicates "Telephone" is connected, the Phone & Media Tab on the Audio/Intercom Page provides the ability to answer, ignore (do not answer), and end Bluetooth phone calls and the Data Bar's audio panel controls provide indications of the status of a Bluetooth phone call.

- System Overview
- Flight Instruments
- EIS
- CNS Interface**
- GPS Navigation
- Flight Planning
- Hazard Avoidance
- Additional Features
- AFCS
- Annun/Alerts
- Appendix
- Index

## TELEPHONE AUDIO

The Telephone Audio button allows enables/disables the telephone's audio to the intercom system for both the wired and Bluetooth telephone connections.

Button Status	Description	Connection Description
 Enabled (Green)	Telephone audio is active (i.e., connected to the intercom).	Wired Connection: The audio of the telephone is connected to the intercom and the pilot may participate in existing calls. Controlling the call (i.e., answer/hang up) is not supported, the ringing of an incoming call may be heard but the actual phone must be used to answer (and end) the call.
		Bluetooth Connection: The ringing of an incoming call may be heard via the intercom, and the pilot may ignore/answer/end the call via the provided GDU controls.
 Disabled (Gray)	Telephone audio is not active (i.e., connected to the intercom).	Wired Connection: Telephone operations are not supported via the intercom, and there are no indications of incoming or existing calls.
		Bluetooth Connection: The ringing of an incoming call and the audio of an existing call are not heard via the intercom. The GDU provides an indication of an incoming call via the data bar's audio panel button (flashing "TEL" indicator) and the Audio Panel page to allow the pilot to answer it - which automatically transitions "Telephone Audio" to enabled.  Also, the Audio Panel page provides an indication of an existing call (via "Call Active") allowing the pilot to join in the call via the intercom by enabling "Telephone Audio".







- System Overview
- Flight Instruments
- EIS
- CNS Interface
- GPS Navigation
- Flight Planning
- Hazard Avoidance
- Additional Features
- AFCs
- Annun/Alerts
- Appendix
- Index

## TELEPHONE DATA BAR CONTROLS

To provide an immediate indication of the state of a Bluetooth phone call at all times (without having to access the Audio/Intercom page), the Audio Box on the Data Bar provides the status of a Bluetooth phone call to indicate:

- No call is active
- A call is incoming (i.e., phone is ringing)
- A call is active

These controls also display the intercom isolation states per the following table.

Audio Box Format			Description
Normal	Minimized	Audio Only	
			Call active, no intercom isolation
			Call active, with intercom isolation

Pressing Audio on the Data Bar when a Bluetooth phone call is “incoming” or “active” directly accesses the Phone/Media tab on the Audio/Intercom page to provide instant access to the phone controls.

## TELEPHONE CONTROLS

The Phone & Media Tab on the Audio/Intercom Page provides the ability to answer, ignore (i.e., do not answer), and end Bluetooth phone calls.

At the top of the tab, the Media title and controls are replaced with the phone call status and controls. The “Media” title is replaced with “Incoming Call” or “Call Active” and the media buttons are replaced with the phone’s call volume control and the ability to set the external device’s phone volume and ignore/answer/end the call.

Also, the caller’s phone number is displayed above the phone controls if provided by the external device.

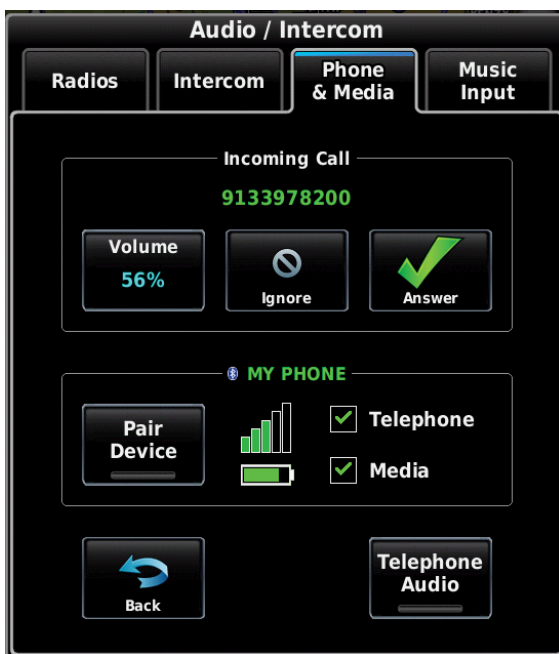

Incoming Call (Phone is Ringing)

- System Overview
- Flight Instruments
- EIS
- CNS Interface
- GPS Navigation
- Flight Planning
- Hazard Avoidance
- Additional Features
- AFCs
- Annun/Alerts
- Appendix
- Index



Active Call (Call is in Progress)



Telephone Volume Adjust Slider

- System Overview
- Flight Instruments
- EIS
- CNS Interface**
- GPS Navigation
- Flight Planning
- Hazard Avoidance
- Additional Features
- AFCs
- Annun/Alerts
- Appendix
- Index

## MUSIC INPUT TAB

The following paragraphs describe the functions accessible from the Music Input Tab.

### Selecting the Music Input tab:

- 1) Touch **Audio** on the CNS Data Bar.
- 2) Touch the **Music Input** tab (if needed.)



Audio/Intercom Page, Music Input Tab

## PILOT MUSIC/COPILOT MUSIC/PASSENGERS MUSIC

These buttons enable/disable the individual music source for the separate intercom stations. The supported music sources are two (wired) inputs and one (wireless) Bluetooth input. Note that the Source names for the Music 1 and Music 2 (wired) inputs are defined in configuration mode (SXM, DVD, etc., as shown in preceding figure), the Bluetooth input Source name is Bluetooth and cannot be changed.

## Selecting Source:

- 1) Touch **Source** for Pilot, Copilot, or Passengers on Music Input Tab.
- 2) Touch **Music 1, Music 2, or Bluetooth** to select the audio source.

## Adjusting Volume:

A volume adjust slider is used to set the selected volume on G3X Touch systems with a GMA 245R. Volume controls are not present on G3X Touch systems with a GMA 245, volume is controlled using the knobs on the GMA 245 instead.

- 1) Touch **Volume** for Pilot, Copilot, or Passengers on Music Input Tab (**Volume** is displayed for Pilot or Copilot for GMA 245R units only).
- 2) Touch the slider to adjust the percentage.

## MUSIC DISTRIBUTION

Selecting Normal using the Distribution button overrides the individual music controls for the copilot and passengers intercom stations. Normal sets all music selections (enable/disable, source, and volume) for the specified intercom station to the same settings as the currently selected pilot settings. With Normal selected, the system behaves as if it has only a single music interface.

The Advanced selection allows the individual selection of separate music interfaces for pilot, copilot, and passengers.

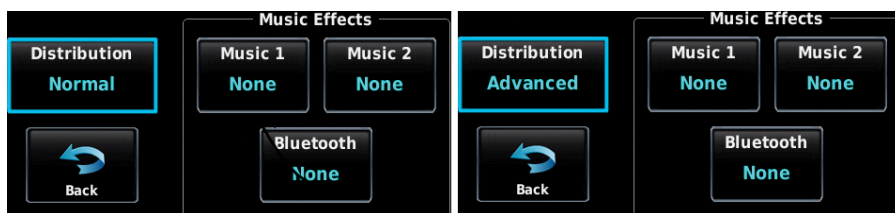

Distribution Button Selections

## MUSIC EFFECTS

The Music 1, Music 2, and Bluetooth sections have music effect selections as follows:

- Bass Boost - Available settings are None, Medium, and High
- Equalizer - Available settings are None, Rock, Classical, and Pop

## 4.5 REMOTE TRANSPONDER INTERFACE (OPTIONAL)

The G3X Touch is capable of interfacing with several remote transponders providing Mode S interrogation and reply capabilities. Selective addressing or Mode Select (Mode S) capability includes the following features:

- Level-2 reply data link capability (used to exchange information between aircraft and ATC facilities)
- Surveillance identifier capability
- Flight ID (Flight Identification) reporting - The Mode S Transponder reports identification as either the aircraft registration or a unique Flight ID.
- Altitude Reporting
- Airborne status determination
- Transponder capability reporting
- Mode S Enhanced Surveillance (EHS) requirements
- Acquisition squitter - Acquisition squitter, or short squitter, is the transponder 24 bit identification address. The transmission is sent periodically, regardless of the presence of interrogations. The purpose of the acquisition squitter is to enable Mode S ground stations and aircraft equipped with a Traffic Avoidance System (TAS) to recognize the presence of Mode S-equipped aircraft for selective interrogation.



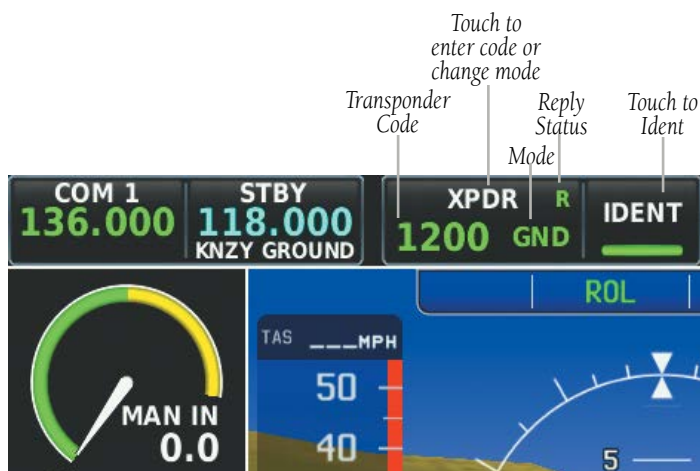

Transponder Data Box on CNS Bar

Transponder tuning for panel mount transponders like GTX 327 (Mode C) and GTX 330ES is also supported.

## TRANSPONDER CODE AND MODE SELECTION

The transponder mode will automatically switch between GND Mode and ALT Mode.

### Selecting a transponder code or mode:

- 1) Touch the transponder data box on the PFD.
- 2) Use the keypad to enter a code and touch **Enter**.

#### Or:

Touch **STBY**, **GND**, **ON**, or **ALT** to change the mode, and touch **Enter**.

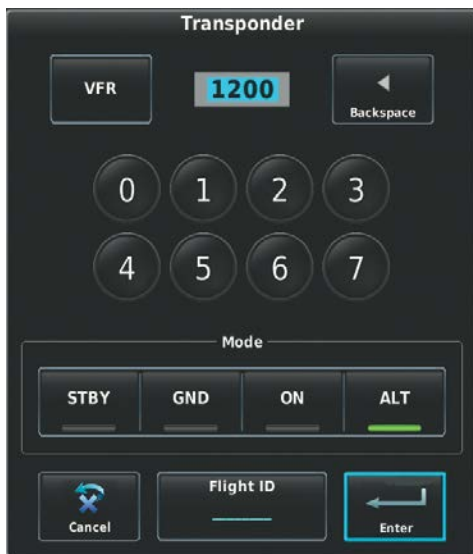

Transponder Code, Mode, and Flight ID Entry

## GROUND MODE

Ground Mode is normally selected automatically when the aircraft is on the ground. The transponder powers up in the last mode it was in when shut down. A green GND indication and transponder code appear in the mode field of the Transponder Data Box. In Ground Mode, the transponder does not allow Mode A and Mode C replies, but it does permit acquisition squitter and replies to discretely addressed Mode S interrogations.

## STANDBY MODE (MANUAL)

In Standby, the transponder does not reply to interrogations, but new codes can be entered. When Standby Mode is selected, a white STBY indication and transponder code appear in the mode field of the Transponder Data Box.

## MANUAL ON MODE

ON Mode can be selected at any time. ON Mode generates Mode A and Mode S replies, but Mode C altitude reporting is inhibited. In ON Mode, a green ON indication and transponder code appear in the mode field of the Transponder Data Box.

## ALTITUDE MODE (AUTOMATIC OR MANUAL)

Altitude Mode is automatically selected when the aircraft becomes airborne. Altitude Mode may also be selected manually.

If Altitude Mode is selected, a green ALT indication and transponder code appear in the mode field of the Transponder Data Box, and all transponder replies requesting altitude information are provided with pressure altitude information.

## REPLY STATUS

When the transponder sends replies to interrogations, a green R indication appears momentarily in the Transponder Data Box.

## VFR CODE

The VFR code can be entered either manually or by touching **VFR** on the Transponder Page. The pre-programmed VFR code is automatically displayed in the code field of the Transponder Data Box.

## IDENT FUNCTION (GDU 46X)



**NOTE:** The Ident function on the GDU 45X is displayed on the Transponder Page when touching the Transponder Data Box on the PFD.

Touching **IDENT** sends a distinct identity indication to Air Traffic Control (ATC). The indication distinguishes the identifying transponder from all the others on the air traffic controller's screen. After touching **IDENT** the bar on the button turns green momentarily.

## ADS-B OUT

When configured with an ADS-B Out capable transponder, '**NO ADSB**' is displayed in yellow, in the Transponder Data Box, if the ADS-B Out broadcast has been manually disabled or if the transponder does not have the required GPS data.

## FLIGHT ID REPORTING



**NOTE:** The Flight ID must be configured to 'Set By Pilot' in Configuration Mode for the **Flight ID** option to appear on the Transponder Page. Refer to the G3X Touch Installation Manual for more information.

### Entering a Flight ID:

- 1) Touch the transponder data box on the PFD.
- 2) Touch **Flight ID**.
- 3) Enter the Flight ID using the keypad and touch **Enter**.



Flight ID (Transponder Data Box) (GDU 46X)

# SECTION 5 GPS NAVIGATION

## 5.1 INTRODUCTION

The Map Page displays aviation data (e.g., airports, VORs, airways, airspaces), geographic data (e.g., cities, lakes, highways, borders), and topographic data (map shading indicating elevation) to be used for situational awareness only. The Navigation Map can be oriented three different ways: North Up (NORTH UP), Track Up (TRK UP) or Desired Track Up (DTK UP).

An aircraft icon is placed on the Navigation Map at the location corresponding to the calculated present position. The aircraft position and the flight plan legs are accurately based on GPS calculations. The basemap upon which these are placed is from a source with less resolution, therefore the relative position of the aircraft to map features is not exact. The leg of the active flight plan currently being flown is shown as a magenta line on the navigation map. The other legs are shown in white.

The Direct-to Window and the Nearest Pages can be displayed by pressing the corresponding hardkeys.

### COMPASS ARC



**NOTE:** The compass arc is not available in 'North Up' map orientation.

A compass arc representing the aircraft's ground track, appears by default on the Map Page. The route line represents the course.

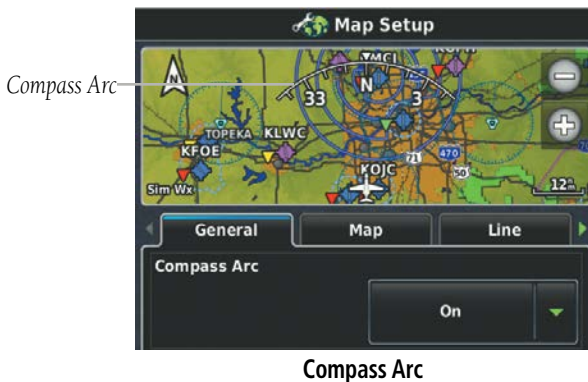

- System Overview
- Flight Instruments
- EIS
- CNS Interface
- GPS Navigation**
- Flight Planning
- Hazard Avoidance
- Additional Features
- AFCS
- Annun/Alerts
- Appendix
- Index

### Enabling/disabling the Compass Arc:

- 1) With the Map Page displayed, press the **MENU** Key.
- 2) Touch **Set Up Map**.
- 3) Under the 'General' Tab, touch and drag to scroll down to the **Compass Arc** field.
- 4) Touch .
- 5) Touch **On** or **Off**.

When using the compass arc on the map display, the heading reference will be shown as a magenta line for several seconds. If a cross wind is present, the ownship symbol will rotate slightly to show the difference between the aircraft's heading and ground track.

## 5.2 USING MAP DISPLAYS



**WARNING:** *The G3X Touch map displays are to be used for situational awareness only.*

Map displays are used extensively in the G3X Touch to provide situational awareness in flight. Most G3X Touch maps can display the following information:

- Airports, NAVAIDs, airspaces, airways, land data (highways, cities, lakes, rivers, borders, etc.) with names
- Map Pointer information (distance and bearing to pointer, location of pointer, name, and other pertinent information)
- Map range
- Aircraft icon (representing present position)
- Flight plan legs
- User waypoints
- Track vector
- Topography data

The information in this section applies to the following maps unless otherwise noted:

- All Map Pages (MAP)
- Waypoint Page (WPT)
- All Nearest Pages (NRST)
- Active Flight Plan Page
- Direct-to Window

## MAP PAGE SETUP

### MAP ORIENTATION

Maps are shown in one of three different orientation options, allowing flexibility in determining aircraft position relative to other items on the map (North Up) or for determining where map items are relative to where the aircraft is going (Track Up), or desired track up (DTK Up).

- North Up aligns the top of the map display to north (default setting).
- Track Up aligns the top of the map display to the current ground track.
- Desired Track (DTK) Up aligns the top of the map display to the desired course.



**NOTE:** Map orientation can only be changed on the Map Page. Any other pages that show navigation data reflect the orientation selected for the Map Page.

### Changing the Navigation Map orientation:

- 1) With the Map Page displayed, press the **MENU** Key.
- 2) Touch **Set Up Map**.
- 3) Under the 'General' Tab, touch and drag to scroll to the **Orientation** field.
- 4) Touch .
- 5) Touch **North Up**, **Track Up**, or **DTK Up**.

### Setting the range above which to display North Up orientation:

- 1) With the Map Page displayed, press the **MENU** Key.
- 2) Touch **Set Up Map**.
- 3) Under the 'General' Tab, touch and drag to scroll to the **North Up Above** field.
- 4) Touch .
- 5) Touch the desired range.

### Enabling/disabling North Up orientation on the ground:

- 1) With the Map Page displayed, press the **MENU** Key.
- 2) Touch **Set Up Map**.
- 3) Under the 'General' Tab, touch and drag to scroll to the **North Up On Ground** field.
- 4) Touch .
- 5) Touch **On** or **Off**.

## AIRPORTS & NAVAIDS

Airport and NAVAID information can be customized to display a variety of information including: runway extension lines, runway numbers and visual reporting points (VRP). Runway extension lines show runway orientation relative to other landmarks and terrain features and are intended to aid in planning traffic pattern entry and/or departure routing.



Runway Extensions and Numbers (Map Page)

### Setting up and customizing airports and NAVAIDs for the map page:

- 1) With the Map Page displayed, press the **MENU** Key.
- 2) Touch **Set Up Map**.



- 3) Touch and drag the tabs left or right to find the desired tab.
- 4) Touch the 'Airport' or 'Navaid' Tab.
- 5) Touch the  to display a list of options.
- 6) Touch the desired settings for each feature (on, off, auto, range, text size, etc.)

## AIRSPACE

### Setting up and customizing airspace for the map page:

- 1) With the Map Page displayed, press the **MENU** Key.
- 2) Touch **Set Up Map**.
- 3) Touch and drag the tabs left or right to find the desired tab.
- 4) Touch the 'Airspace' Tab.
- 5) Touch the  to display a list of options.
- 6) Touch the desired option for each airspace (on, off, auto, range, all (Atlantic), or below (Atlantic)).

## MAP RANGE



**NOTE:** Refer to the *Additional Features* section for information on changing the FliteCharts® or ChartView range.

There are 23 different map ranges available, from 200 feet to 800 nm. The current range is indicated in the lower right corner of the map. The scale bar represents the map scale. To change the map range on any map, use the knob or touch the '+' (decreasing) or the '-' (increasing).



Map Range

Scale Bar Representing a Map Scale of 3 nm Per Scale Width.

## AUTO ZOOM

Auto Zoom allows the G3X Touch to change the map display range to the smallest range clearly showing the active waypoint. Auto Zoom can be overridden by adjusting the range and remains that way until the active waypoint changes, a terrain or traffic alert occurs, or the aircraft takes off.



### Enabling/disabling Auto Zoom:

- 1) With the Map Page displayed, press the **MENU** Key.
- 2) Touch **Set Up Map**.
- 3) Under the 'General' Tab, find the **Autozoom** field.
- 4) Touch .
- 5) Touch **On** or **Off**.

## MAP PANNING

Map panning allows the pilot to:

- View parts of the map outside the displayed range without adjusting the map range
- Highlight and select locations on the map
- Review information for a selected airport, NAVAID or user waypoint
- Designate locations for use in flight planning
- View airspace and airway information

To pan the map, touch and drag the map. Touch a map feature to get additional information. The map feature button shows not only the feature name (such as airport designation or waypoint name) but also shows the type (airport, waypoint, etc). If multiple features are present at the map feature position, a green arrow will appear on the map feature button. Touch  or  to cycle through the list of map features present at that position.

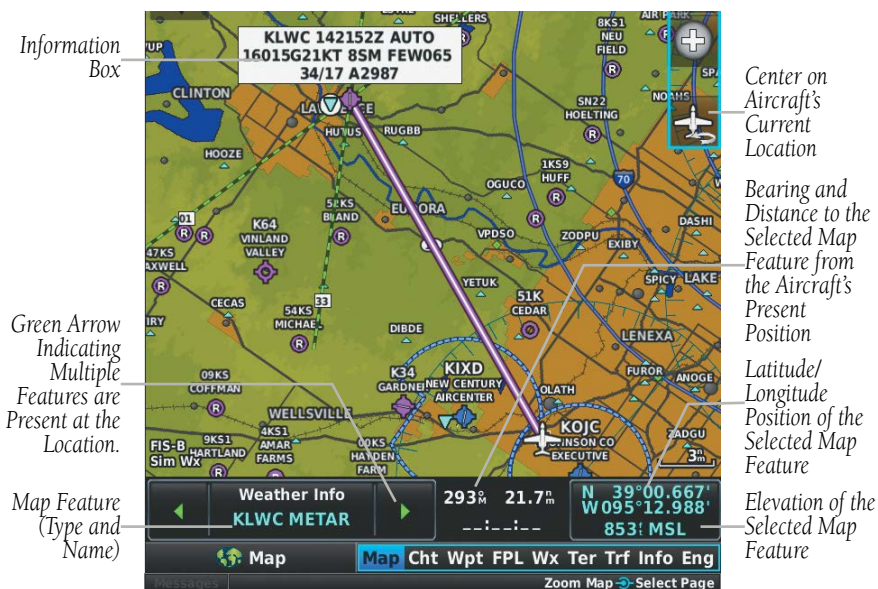

Map Panning (Map Page)

### Panning the map:

- 1) From any map, touch and drag.
- 2) Touch  to re-center the map on the aircraft's current position,

### Reviewing information for a map feature:

- 1) From any map, touch a map feature.
- 2) If multiple map features are present, touch  to cycle through the list.
- 3) Touch the Map Feature button to display additional information.

- System Overview
- Flight Instruments
- EIS
- CNS Interface
- GPS Navigation
- Flight Planning
- Hazard Avoidance
- Additional Features
- AFCs
- Annun/Alerts
- Appendix
- Index

## FUEL RANGE RING



**WARNING:** The G3X Touch Fuel Calculator and/or Fuel Range Rings are NOT intended to be relied upon as the primary fuel indicator(s), and does not relieve the pilot from the responsibility of proper flight planning. G3X Touch fuel calculations do not use the aircraft fuel quantity indicators and are calculated from the last time the fuel was reset.

The Navigation Map can display fuel range rings which show the remaining flight distance. If current fuel endurance is greater than reserve, range-to-empty is shown as a solid green circle and range-to-reserve is a dashed green circle. If current endurance is less than reserve, range-to-empty is shown as a solid yellow circle. Fuel range rings are offset to show the effects of the wind at the current location (e.g., does not account for wind variations throughout the range).

### Displaying/removing the fuel range rings and selecting a fuel reserve time:

- 1) With the Map Page displayed, press the **MENU** Key.
- 2) Touch **Set Up Map**.
- 3) Touch and drag the tabs left or right to find the desired tab.
- 4) Touch the 'Map' Tab.
- 5) Touch the  in the **Fuel Range (RSV)** field, and touch **On** or **Off**.
- 6) Touch '+' or '-' to adjust the fuel range reserve time.

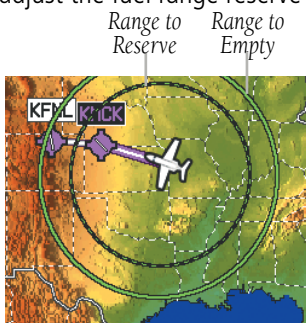

Navigation Map

### GLIDE RANGE RING



**NOTE:** In order for the Glide Range Ring to display on the map, Best Glide Speed ( $V_G$ ) and Sink Rate (at  $V_G$ ) must be configured on the Aircraft Configuration Page in Configuration Mode. Refer to the G3X Touch Installation Manual for more information.



**NOTE:** Many factors, such as winds at various altitudes, terrain, and even pilot actions affect the ability to accurately estimate the gliding range of an aircraft. The displayed Glide Range Ring should not be considered a replacement for in-flight emergency pilot training.

The Glide Range Ring is displayed as a cyan ring around the estimated area that can be reached by the aircraft in the best glide range configuration. The Glide Range Ring fades into view on the map as the aircraft climbs through 500 feet AGL. The range is based on the Best Glide Speed ( $V_G$ ) and Sink Rate (at  $V_G$ ) entered by the pilot. Best Glide and Sink Rate are combined with the aircraft's height (AGL), wind, and bank angle to determine the distance the aircraft can travel.

Glide Range Ring



Navigation Map - Glide Range Ring  
(Ideal Descent Profile - No Wind)



Navigation Map - Glide Range Ring  
(Ideal Descent Profile - Wind 245° at 25 kts)

When the aircraft is not being flown in an ideal best glide descent, the range of the cyan circle decreases and arrows are displayed depicting how far the aircraft is from an ideal descent profile.



Navigation Map - Glide Range Ring  
(NOT Ideal Descent)

### Enabling/disabling the Glide Range Ring:

- 1) With the Map Page displayed, press the **MENU** Key.
- 2) Touch **Set Up Map...**
- 3) Touch and drag the tabs left or right to find the desired tab.
- 4) Touch the 'Map' Tab.
- 5) Touch and drag the page up or down to find the **Glide Range Ring** field.
- 6) Touch the  in the **Glide Range Ring** field, and touch **On** or **Off**.



*Touch to  
Enable or  
Disable the  
Glide Range  
Ring*

Map Setup Page

## BEST AIRPORT BEARING POINTER



**NOTE:** In order to display the Best Airport Bearing Pointer, Best Glide Speed and Sink Rate (at VG) must be configured on the Aircraft Configuration Page in Configuration Mode. Refer to the G3X Touch Installation Manual for more information.



**NOTE:** Many factors such as winds at various altitudes, terrain, and even pilot actions affect the ability to accurately estimate the gliding range of an aircraft. The displayed Glide Range Ring should not be considered a replacement for normal pilot training to deal with in-flight emergencies.

The Best Airport Bearing Pointer points to the airport within the Glide Range Ring that is considered the best option for a landing based on the following criteria:

- 1) The airport must be within glide range as determined by the following:
  - a) User entered glide performance (Sink Rate and Best Glide Speed).
  - b) Aircraft altitude and direction of flight.
  - c) Airport elevation.
  - d) Wind velocity.
- 2) The expected flyover altitude (i.e., airports with 1000' or greater margin take precedence).
- 3) Hard surface runways (i.e., paved runways take precedence over grass runways).
- 4) Runway lengths.
- 5) Runway alignment with the wind (if known).

**Enabling/disabling the Best Airport Bearing Pointer:**

- 1) With the full screen PFD displayed, press the **MENU** Key.
- 2) Touch  next to a bearing pointer to display the bearing pointer options.
- 3) Touch **Best Airport**.

*Touch to Display the Best Airport Bearing Pointer*



**PFD Options**



*Bearing 1 Information Window  
-Identifier  
-Bearing Source*

*Bearing 2 Information Window  
-Identifier  
-Distance*

**HSI with Bearing Pointers**

System Overview

Flight Instruments

EIS

CNS Interface

GPS Navigation

Flight Planning

Hazard Avoidance

Additional Features

AFCs

Annun/Alerts

Appendix

Index



### BEST AIRPORT LINE

The Best Airport Line points the same airport that the Best Airport Bearing Pointer points to, but available on MFD and Split Screen Map displays instead of the HSI. The line appears as a series of cyan chevrons between the aircraft marker and the recommended glide-to airport.

#### Displaying/removing the Best Airport Line:

- 1) With the Map Page displayed, press the **MENU** Key.
- 2) Touch **Set Up Map**.
- 3) Touch and drag the tabs left or right to find the desired tab.
- 4) Touch the 'Line' Tab.
- 5) In the **Best Airport Line** field, touch **On** or **Off**.

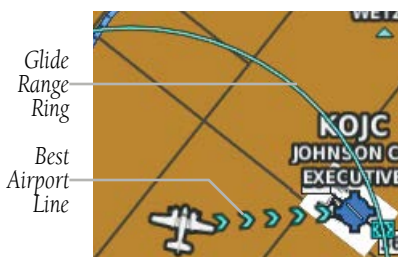

Navigation Map



Navigation Map

### SELECTED ALTITUDE INTERCEPT ARC

The map can display the location along the current track where the aircraft will intercept the selected altitude. The location will be shown as a cyan arc when the aircraft is climbing or descending.

#### Displaying/removing the selected altitude intercept arc:

- 1) With the Map Page displayed, press the **MENU** Key.
- 2) Touch **Set Up Map**.
- 3) Touch and drag the tabs left or right to find the desired tab.
- 4) Touch the 'Map' Tab.
- 5) In the **Selected Altitude Intercept Arc** field, touch **On** or **Off**.

## MEASURING BEARING AND DISTANCE

Distance and bearing from the aircraft's present position to any point on the viewable navigation map may be calculated using the 'Measure Distance' option from Map Page menu. The distance tool displays a dashed Measurement Line and a Map Pointer to aid in graphically identifying points to measure. Lat/Long, bearing, distance, and elevation data is provided.

### Measuring bearing and distance between any two points:

- 1) From the Map Page, press the **MENU** Key.
- 2) Touch **Measure Distance**.
- 3) Touch any point on the viewable navigation map.
- 4) If desired, touch **Set Ref** to set a reference point.

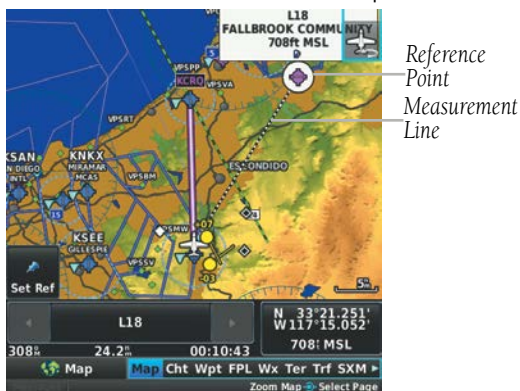

Map Page (Measure Distance)

## TOPOGRAPHY

Topographic data can be displayed or removed as described in the following procedures.

### Displaying/removing topographic data:

- 1) From the Map Page, press the **MENU** Key.
- 2) Touch **Topo Shading**.

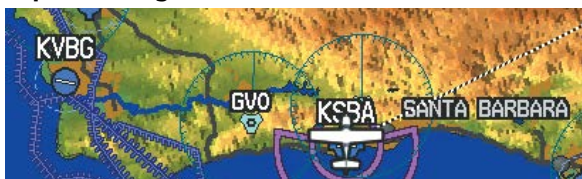

Topographic Shading (Map Page)

## MAP PAGE TRAFFIC

### Enabling/disabling traffic on the Map Page:

- 1) From the Map Page, press the **MENU** Key.
- 2) Touch **Traffic**.

### Enabling/Disabling TargetTrend Overlay:

- 1) From the Map Page, press the **MENU** Key.
- 2) Touch **Set Up Map**.
- 3) Under the 'Traffic' Tab, touch and drag to scroll to the **TargetTrend** field.
- 4) Touch .
- 5) Touch **On** or **Off**.

## MAP SYMBOLS

Refer to Appendix G for a list of map symbols.

### MAP DECLUTTER

The pilot can remove (declutter) unwanted items, such as highways from the map.

#### Decluttering the Map Page:

- 1) From the Map Page, press the **MENU** Key.
- 2) Touch **-1**, **-2**, or **-3** under **Map Detail**.

### MAP DETAIL

The map detail can also be adjusted. Map detail changes the amount of detail with respect to the zoom scale.

- 1) From the Map Page, press the **MENU** Key.
- 2) Touch **Set Up Map**.
- 3) Touch and drag the tabs left or right to find the desired tab.
- 4) Touch the 'General' Tab.
- 5) Touch the  in the **Detail Level** field.
- 6) Touch **Least**, **Less**, **Normal**, **More**, or **Most**.

## 5.3 AIRWAYS



**WARNING:** Do not use the approach information provided by the VFR navigation database residing within the G3X Touch as a means of navigating any instrument approach. The G3X Touch VFR navigation database is limited to present only the waypoints for the final approach leg of a published procedure. These waypoints and associated course line are made available for monitoring purposes only.

Low Altitude Airways (or Victor Airways) primarily serve smaller piston-engine, propeller-driven airplanes on shorter routes and at lower altitudes. Airways are eight nautical miles wide and start 1,200 feet above ground level (AGL) and extend up to but not including 18,000 feet mean sea level (MSL). Low Altitude Airways are designated with a "V" before the airway number (hence the name "Victor Airways") since they run primarily between VORs.

High Altitude Airways (or Jet Routes) primarily serve airliners, jets, turboprops, and turbocharged piston aircraft operating above 18,000 feet MSL. Jet Routes start at 18,000 feet MSL and extend upward to 45,000 feet MSL (altitudes above 18,000 feet are called "flight levels" and are described as FL450 for 45,000 feet MSL). Jet Routes are designated with a "J" before the route number.

Low Altitude Airways are drawn in gray. High Altitude Airways are drawn in green. When both types of airways are displayed, high altitude airways are drawn on top of Low Altitude Airways.

When airways are selected for display on the map, the airway waypoints (VORs, NDBs, and Intersections) are also displayed.

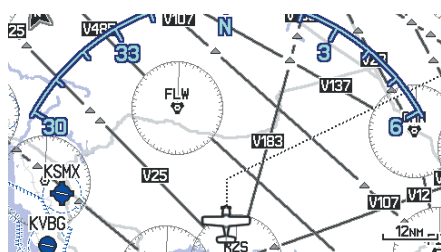



IFR Map

Airways may be displayed on the map at the pilot's discretion.

### Displaying/removing airways:

- 1) From the Map Page, press the **MENU** Key.
- 2) Touch **Set Up Map**.
- 3) Touch and drag the tabs left or right to find the desired tab or turn the large Knob associated with the MFD.
- 4) Touch the 'Map' Tab.
- 5) Touch the  in the **Map Type** field.
- 6) Touch **IFR**.

### Reviewing information for an airway:

- 1) With the IFR map displayed on the Map Page (see procedure above), touch a map feature.
- 2) If multiple map features are present, touch  or  to cycle through the list.
- 3) With the airway selected, touch the Map Feature button to display additional information.



**Low Altitude Airway Review Page**

## 5.4 WAYPOINTS

The Waypoint (Wpt) Page provides airport and waypoint information.

Waypoints are predetermined geographical positions (internal database) or pilot-entered positions, and are used for all phases of flight planning and navigation.

Waypoints can be changed by entering the ICAO identifier, entering the name of the facility, or by entering the city name. As a waypoint identifier, facility name, or location is entered, the G3X Touch's Spell'N'Find™ feature scrolls through the database, displaying those waypoints matching the characters which have been entered up to that point. A direct-to navigation leg to the selected waypoint can be initiated by pressing the Direct-to Key from the Waypoint Page.

The Waypoint Page allows the pilot to review airport information, runway information, frequencies, instrument procedures, airport directory information, and weather information. The pilot can manually enter the identifier or the G3X Touch will choose the most appropriate identifier based on the current position and phase of flight.

The following descriptions and abbreviations are used:

- Usage type: Public, Military, or Private
- Runway surface type: Hard, Turf, Sealed, Gravel, Dirt, Soft, Unknown, or Water
- Runway lighting type: No Lights, Part Time, Full Time, Unknown, or PCL Freq (for pilot-controlled lighting)
- COM Availability: TX (transmit only), RX (receive only), PT (part time), \* (additional information available)

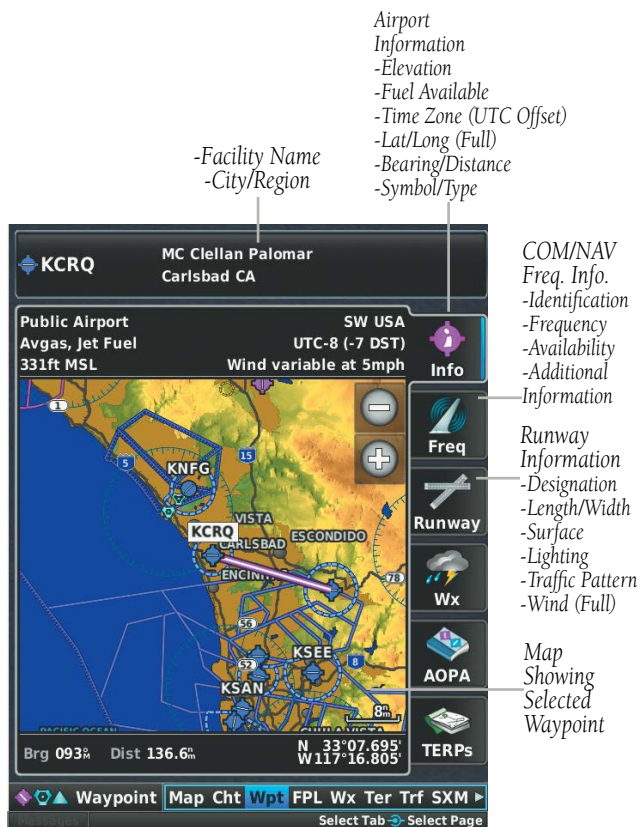

Waypoint Page - Info Tab

### Selecting an airport for review by identifier, facility name, or location:

- 1) From the Waypoint (Wpt) Page, touch the **Info** Tab if necessary.
- 2) Touch the waypoint identifier at the top of the page.
- 3) Enter the waypoint identifier using the keypad and touch **Enter**.

**Or:**

Touch **Find > Search Name > Search by Facility Name**. Enter the facility name using the keypad and touch **Enter**.

**Or:**

Touch **Find > Search City > Search by City**. Enter the city name using the keypad and touch **Enter**.

If duplicate entries exist for an identifier, a Duplicates Found Window is displayed. Touch the desired option options from the Duplicates Found Window.

**Selecting a runway:**

- 1) From the Waypoint (Wpt) Page, touch the **Runway** Tab if necessary.
- 2) Touch the waypoint identifier at the top of the page.
- 3) Enter the waypoint identifier using the keypad and touch **Enter**.
- 4) If necessary, touch the  to display additional runways. Touch the desired runway.

**Viewing additional information for a frequency:**

The **Freq** Tab uses the descriptions and abbreviations listed in the following table:

Communication Frequencies			Navigation Frequencies
Approach *	Control	Pre-Taxi	ILS
Arrival *	CTA *	Radar	LOC
ASOS	Departure *	Ramp	
ATIS	Gate	Terminal*	
AWOS	Ground	TMA *	
Center	Helicopter	Tower	
Class B *	Multicom	TRSA *	
Class C *	Other	Unicom	
Clearance			
* May include Additional Information			

**Frequency Abbreviations**

- 1) With the Waypoint (WPT) Page displayed, touch the **Freq** Tab.
- 2) Touch a frequency denoted with an \* to view additional information.
- 3) Touch **Tune**.



## NEAREST INFORMATION

The G3X Touch provides a **NRST** Key which gives the pilot quick access to nearest airport, weather, VOR, NDB, intersection, user waypoint, city, ARTCC, FSS, VRPs, and airspace information. If none are available, "None Within 200 NM" is displayed.

### Viewing nearest information:

- 1) Press the **NRST** Key.
- 2) Touch the Page Navigation Bar.
- 3) Touch **Airports, Airport WX, VORs, NDBs, Intersections, User WPTs, Cities, ARTCC, FSS, VRPs, or Airspace.**
- 4) Touch the desired option from the list.

## NEAREST AIRPORT CRITERIA

From the Menu on the Nearest Airports Page the pilot can define the minimum runway length and surface type used when determining the 15 nearest airports to display on the Nearest Airports Page. A minimum runway length and/or surface type can be entered to prevent airports with small runways or runways that are not appropriately surfaced from being displayed. Default settings are 0 feet (or meters) for runway length and "Any" for runway surface type. Private airports and Heliports can also be included.

The Page Menu also allows the pilot to choose between displaying the facility names, city names, bearing, or direction arrows.

### Setting nearest airport criteria:

- 1) With the Nearest Airports Page displayed, press the **MENU** Key.
- 2) Touch  to display the Runway Surface options.
- 3) Touch the desired option.
- 4) Touch the **Min Runway Length** value.
- 5) Enter the desired value using the keypad and touch **Enter**.
- 6) Touch **Private Airport** and/or **Heliports**.

### Restoring nearest airport criteria defaults:

- 1) With the Nearest Airports Page displayed, press the **MENU** Key.
- 2) Touch **Set Airport Criteria**.
- 3) Press the **MENU** Key.
- 4) Touch **Restore Default**.

## WEATHER INFORMATION

---

Textual weather information can be viewed from the Waypoint Page or the Nearest Airport WX Page.

### Selecting airport weather information:

From the Waypoint Page, touch the **Wx** Tab.

**Or:**

From the Nearest Airport WX Page, touch the desired airport and touch the **Wx** Tab.

## INTERSECTIONS

---

Intersections can be viewed from the Waypoint Page or the Nearest Intersections Page. In addition to displaying a map of the currently selected intersection and surrounding area, the Intersection Information Page displays the region, bearing, distance, latitude, and longitude.

### Selecting an intersection:

- 1) From the Waypoint (Wpt) Page, touch the **Info** Tab if necessary.
- 2) Touch the waypoint identifier at the top of the page.
- 3) Enter the intersection using the keypad and touch **Enter**.

**Or:**

- 1) Press the **NRST** Key.
- 2) Touch the Page Navigation Bar.
- 3) Touch **Intersections**.
- 4) Touch the desired intersection from the list.

## NDBs

NDBs can be viewed from the Waypoint Page or the Nearest NDBs Page. In addition to displaying a map of the currently selected NDB and surrounding area, the page displays the region, bearing, distance, latitude, longitude, and frequency.

The Nearest NDB Page can be used to quickly find a NDB close to the flight path. The list only includes NDBs that are within 200nm. If there are no NDBs in the list, text indicating that there are no nearest NDBs is displayed. If there are no nearest NDBs in the list, the information and frequency fields are dashed.

### Selecting a NDB:

- 1) From the Waypoint (Wpt) Page, touch the **Info** Tab if necessary.
- 2) Touch the waypoint identifier at the top of the page.
- 3) Enter the NDB identifier using the keypad and touch **Enter**.

**Or:**

- 1) Press the **NRST** Key.
- 2) Touch the Page Navigation Bar.
- 3) Touch **NDBs**.
- 4) Touch the desired NDB from the list.

## VORs

VORs can be viewed from the Waypoint Page or the Nearest VORs Page. In addition to displaying a map of the currently selected VOR and surrounding area, the page displays the region, city, state, bearing, distance, latitude, longitude, frequency, and class (High, Low, or Terminal VOR).

The Nearest VOR Page can be used to quickly find a VOR close to the flight path. The list only includes VORs that are within 200nm. If there are no VORs in the list, text indicating that there are no nearest VORs is displayed. If there are no nearest VORs in the list, the information and frequency fields are dashed.

Localizer information cannot be viewed on the VOR Information Page. If a VOR station is combined with a TACAN station it is listed as a VORTAC on the VOR Information Page and if it includes only DME, it's displayed as VOR-DME.

### Selecting a VOR:

- 1) From the Waypoint (Wpt) Page, touch the **Info** Tab if necessary.
- 2) Touch the waypoint identifier at the top of the page.
- 3) Enter the VOR identifier using the keypad and touch **Enter**.

#### Or:

- 1) Press the **NRST** Key.
- 2) Touch the Page Navigation Bar.
- 3) Touch **VORs**.
- 4) Touch the desired VOR from the list.

## USER WAYPOINTS

The G3X Touch can create and store up to 3,000 user-defined waypoints. Once a waypoint has been created, it can be renamed, deleted, or moved.

### Creating user waypoints:

- 1) Touch anywhere on the map.
- 2) Touch the Latitude/Longitude Location Button.
- 3) Optionally, touch the **Name** field to enter the new waypoint name and touch **Enter**.
- 4) Touch the default symbol.
- 5) Touch the desired symbol and touch **Enter**.
- 6) If desired touch the **Altitude** value.
- 7) Enter the desired altitude and touch **Enter**.
- 8) If desired touch the Location value.
- 9) Touch the arrows to change the location and touch **Enter**.

### Marking Current Location as a Waypoint:

- 1) From the **Info** Page, touch the latitude and longitude.

#### Or:

- 1) From the **Info** Page, press the **MENU** Key, and touch **Mark Waypoint**.
- 2) Touch **Yes** on the confirmation dialog box.
- 3) Optionally touch the **Name** field to rename the waypoint.
- 4) Touch **Back**.

### Creating a proximity waypoint:

- 1) Press the **MENU** Key twice.
  - 2) Touch User WPT.
  - 3) Touch the **Proximity** Tab.
  - 4) Press the **Menu** Key.
  - 5) Touch New Proximity Waypoint.
    - a) Touch **Use Identifier**.
    - b) Enter the desired identifier using the keypad.
- Or:**
- a) Touch **Use Map**.
  - b) Touch anywhere on the map.
- 6) Touch **Enter**.

### Selecting and viewing nearest user waypoints:

- 1) Press the **NRST** Key.
- 2) Touch **User WPTs**.
- 3) Touch the desired user waypoint.

### Editing or renaming a user waypoint:

- 1) Press the **NRST** Key.
- 2) Touch **User WPTs**.
- 3) Touch the desired user waypoint.
- 4) Press the **MENU** Key.
- 5) Touch **Edit Waypoint**.
- 6) Touch the desired field to edit.
- 7) Make the necessary changes and touch **Enter**.

### Deleting user waypoints:

- 1) Press the **NRST** Key.
- 2) Touch **User WPTs**.
- 3) Touch the desired user waypoint.
- 4) Press the **MENU** Key.
- 5) Touch **Delete Waypoint**.
- 6) Touch **Yes**.

## AUTOMATIC WAYPOINT SELECTION

Automatic waypoint selection is the system's attempt to deduce what Waypoint to display based on the aircraft's location in relation to the departure airport and/or the waypoints in the Flight Plan.

The pilot can override Automatic Waypoint Selection by manually entering a waypoint. The automatic selection will not resume until such time that the manually entered waypoint and the automatically selected waypoint coincide.

## 5.5 AIRSPACE

The Nearest Airspace Page and Airspace Alerts provide information about airspaces and the location of the aircraft in relationship to them. The Nearest Airspace Page can be used to quickly find airspaces close to the flight path.

The Nearest Airspace Page displays the class of airspace, controlling agency, vertical boundaries, and status.

### Selecting and viewing nearest airspaces:

- 1) Press the **NRST** Key.
- 2) Touch the Page Navigation Bar.
- 3) Touch **Airspace**.
- 4) Touch the desired airspace.

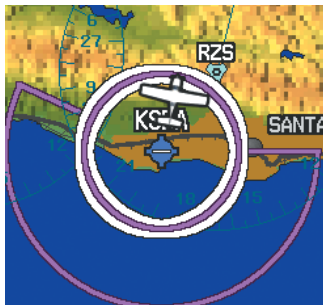

Nearest Airspace Page Map

## AIRSPACE ALERT MESSAGES

When an airspace alert appears, press the **NRST** Key to automatically show nearby airspace information on the Nearest Airspace Page. This information includes name, time to entry (if applicable), and status.

There are four types of status information:

- Ahead—Projected to enter the airspace within the next 10 minutes or less
- Near—Within two nautical miles of an airspace but not projected to enter it
- Near & Ahead—Projected to enter the airspace within two nautical miles
- Inside Airspace—Within the boundaries of the airspace

## SMART AIRSPACE™ WITH ALTITUDE OVERLAYS

Smart Airspace™ integration makes it easier for pilots to identify what airspace lies ahead. This feature conveniently highlights the airspace nearest to the aircraft's current altitude and de-emphasizes non-pertinent airspace so pilots can quickly distinguish their location to the relevant airspace around them.

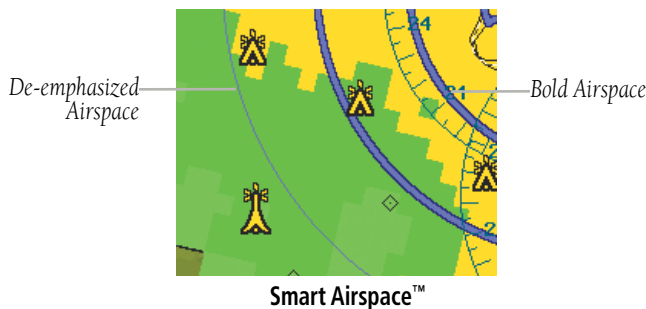

Additionally, newly incorporated airspace altitude overlays are depicted on the moving map and reduce pilot workload, particularly in congested airspace. With airspace altitude overlays, pilots can easily view airspace maximum and minimum altitudes within the U.S., so it's easier to identify airspace altitude limitations at a glance.



Smart Airspace™ with Altitude Overlays

## 5.6 DIRECT-TO NAVIGATION USING THE G3X TOUCH

The Direct-to method of navigation, initiated by pressing the **Direct-to** Key is quicker to use than a flight plan when the desire is to navigate to a single point such as a nearby airport.

Once a direct-to is activated, the G3X Touch establishes a point-to-point course line from the present position to the selected direct-to destination. Course guidance is provided until the direct-to is replaced with a new direct-to or flight plan, or cancelled.

### Entering a waypoint identifier, facility name, or city as a direct-to destination:

- 1) Press the **Direct-to** Key. The Direct-to Window is displayed (with the active flight plan waypoint as the default selection or a blank waypoint field if no flight plan is active).
- 2) If an external navigator is configured, touch **FPL Source** > **Internal** from the FPL Page.



- 3) Touch the waypoint identifier.
- 4) Enter the waypoint identifier using the keypad and touch **Enter**.

**Or:**

Touch **Find > Search Name > Search by Facility Name**. Enter the facility name using the keypad and touch **Enter**.

**Or:**

Touch **Find > Search City > Search by City**. Enter the city name using the keypad and touch **Enter**.

- 5) Touch **Activate**.

### Entering latitude and longitude coordinates as a direct-to destination:

- 1) Press the **Direct-to** Key. The Direct-to Window is displayed
- 2) Press the **MENU** Key.
- 3) Touch **Enter Coordinates**.
- 4) Use the on-screen directional arrows or the knobs to specify coordinates, and touch **Enter**.
- 5) Touch **Activate**.

### Selecting Recent Waypoints, Nearest Airports, Flight Plan Waypoints, or User Waypoints as a direct-to destination:

- 1) Press the **Direct-to** Key. The Direct-to Window is displayed (with the active flight plan waypoint as the default selection or a blank waypoint field if no flight plan is active).
- 2) If an external navigator is configured, touch **FPL Source > Internal** from the FPL Page.
- 3) Touch the waypoint identifier.
- 4) Touch **Find**
- 5) Touch the **Recent** Tab.

**Or:**

Touch the **Nearest Airports** Tab.

**Or:**

Touch the **Flight Plan** Tab.

**Or:**

Touch the **User** Tab.

- 6) Touch the desired waypoint.
- 7) Touch **Activate**.

### Selecting a waypoint as a direct-to destination using the pointer:

- 1) Touch anywhere on the map.
- 2) Press the **Direct-to** Key.
- 3) If an external navigator is configured, touch **FPL Source** > **Internal** from the FPL Page.
- 4) Touch **Activate**.

### Cancelling or resuming a direct-to:

- 1) Press the **Direct-to** Key.
- 2) If an external navigator is configured, touch **FPL Source** > **Internal** from the FPL Page.
- 3) Touch **Stop Navigation** or **Resume Flight**.

## OBS MODE

### Enabling/disabling OBS Mode (without external GPS navigator):

- 1) While navigating a flight plan or Direct-to, touch **CRS** on the PFD.
- 2) Touch **Yes** on the 'Set OBS and hold?' window.
- 3) Enter the desired course to/from the waypoint using the keypad and touch **Enter**.
- 4) To cancel OBS Mode and return to automatic waypoint sequencing, touch **OBS** on the PFD.
- 5) Touch **Release OBS Hold**.

### OR

- 1) From the Active Flight Plan Page press the **MENU** Key while navigating a flight plan or Direct-to.
- 2) Touch **Set OBS and Hold**.
- 3) Touch **Sync Course** or enter the desired course to/from the waypoint using the keypad and touch **Enter**.
- 4) To cancel OBS Mode and return to automatic waypoint sequencing, press the **MENU** Key.
- 5) Touch **Release Hold**.

- System Overview
- Flight Instruments
- EIS
- CNS Interface
- GPS Navigation**
- Flight Planning
- Hazard Avoidance
- Additional Features
- AFCS
- Annun/Alerts
- Appendix
- Index

Blank Page

## SECTION 6 FLIGHT PLANNING

### 6.1 INTRODUCTION



**NOTE:** In order to add, delete, or change flight plan waypoints from the G3X Touch when an external GPS navigator is configured, touch **FPL Source** > **Internal** from the Active Flight Plan Page or Direct-to Page. Press the **FPL Source** > **External** to return to the external GPS navigator's flight plan.



**NOTE:** While navigating using an external GPS navigation source, the ability to edit/invert/delete the Active Flight Plan or activate a Saved Flight Plan is disabled.



**NOTE:** Refer to section 8.11 (Connex Cockpit Connectivity) for information on wirelessly transferring flight plans from a mobile device (using Garmin Pilot) to the G3X Touch or external navigator (if configured).

Flight planning on the G3X Touch consists of building a flight plan by entering waypoints one at a time and inserting approaches as needed. The flight plan is displayed on maps using different line widths, colors, and types, based on the type of leg and the segment of the flight plan currently being flown.

Up to 50 flight plans with up to 300 waypoints each can be created and stored in memory. One flight plan can be activated at a time and becomes the active flight plan. The active flight plan is erased when the destination is reached and the system is turned off. When storing flight plans with an approach, the G3X Touch uses the waypoint information from the current database to define the waypoints. If the database is changed or updated, the G3X Touch automatically updates the information if the procedure has not been modified. If an approach is no longer available, the procedure is deleted from the affected stored flight plan(s), and an alert is displayed.

Whenever an approach is loaded into the active flight plan it replaces the destination airport with a sequence of waypoints for the selected approach. The airport must have a published instrument approach and only the final course segment (usually from final approach fix to missed approach point) of the published approach is available if an external navigator (i.e., GTN or GNS Series) is not configured.

## FLIGHT PLAN DATA FIELDS

### Changing the information shown in the flight plan data fields:

- 1) With a flight plan displayed, touch **FPL Source** > **Internal** if an external navigator is configured (Active Flight Plan only).
- 2) Touch one of the data fields to change.
- 3) Touch the desired data field.

## MANUALLY SWITCHING BETWEEN INTERNAL AND EXTERNAL FLIGHT PLAN SOURCES



**NOTE:** The selection of the internal GPS navigation source to persist through power cycles or reset to the external GPS navigation source is dependant on the configuration. Refer to the G3X Touch Installation Manual for more information.

Touch **FPL Source** > **Internal** on the Active Flight Plan Page or the Direct-to Page, to temporarily allow flight planning through the G3X Touch using the internal GPS flight plan when an external GPS Navigator is configured. Press the **FPL Source** > **External** to return to the external GPS navigator's flight plan.

When manually selecting the internal GPS flight plan, 'INT' is displayed in light blue in the lower left quadrant of the HSI.

### Switching between internal and external flight plan sources:

From the Active Flight Plan Page or the Direct-to Page, touch **FPL Source** > **Internal** or **FPL Source** > **External** to switch between the internal and external flight plan sources when an external GPS Navigator is configured.

## FAILURE OF THE EXTERNAL GPS NAVIGATION SOURCE

If the external GPS navigation source fails, the system reverts to the internal GPS navigation source and 'REV' is shown in yellow in the lower left quadrant of the HSI.

## 6.2 FLIGHT PLAN CREATION USING THE G3X TOUCH

The active flight plan is listed on the Active Flight Plan Page. It is the flight plan to which the G3X Touch is currently providing guidance, and is shown on the navigation maps. Stored flight plans are listed on the Flight Plan List Page, and are available for activation (becomes the active flight plan).



Active Flight Plan Page

### Creating an active flight plan using the G3X Touch:

- 1) Touch the Page Navigation Bar.
- 2) Touch **Active FPL**.
- 3) If an external navigator is configured, touch **FPL Source** > **Internal**.
- 4) Touch **Add Waypoint**.

- 5) Enter the waypoint using the keypad.

**Or:**

Touch **Find** > **Search Name** > **Search by Facility Name**. Enter the facility name using the keypad.

**Or:**

Touch **Find** > **Search City** > **Search by City**. Enter the city name using the keypad.

**Or:**

Touch **Find** > **Recent** Tab.

**Or:**

Touch **Find** > **Nearest Airports** Tab.

**Or:**

Touch **Find** > **Flight Plan** Tab.

**Or:**

Touch **Find** > **User** Tab.

- 6) Touch **Enter**.

- 7) Repeat steps 4-6 for each additional waypoint.

### Creating a stored flight plan using the G3X Touch:

- 1) Press the **MENU** Key twice.

- 2) Touch **FPL List**.

- 3) Press **MENU**.

- 4) Touch **New Flight Plan**.

- 5) Touch **Add Waypoint**.

- 6) Enter the waypoint using the keypad.

**Or:**

Touch **Find** > **Search Name** > **Search by Facility Name**. Enter the facility name using the keypad.

**Or:**

Touch **Find** > **Search City** > **Search by City**. Enter the city name using the keypad.

**Or:**



Touch **Find** > **Recent** Tab.

**Or:**

Touch **Find** > **Nearest Airports** Tab.

**Or:**

Touch **Find** > **Flight Plan** Tab.

**Or:**

Touch **Find** > **User** Tab.

- 7) Touch **Enter**.
- 8) Repeat steps 4-6 for each additional waypoint.
- 9) The new flight plan is now in the list.

## 6.3 FLIGHT PLAN STORAGE USING THE G3X TOUCH

The G3X Touch can store up to 50 flight plans. The active flight plan is erased when another flight plan is activated. Details about each stored flight plan can be viewed on the Flight Plan List Page

### Viewing information about a stored flight plan:

- 1) Press the **MENU** Key twice.
- 2) Touch **FPL List**.
- 3) Touch the desired flight plan.

### Storing an active flight plan from the Active Flight Plan Page:

- 1) From the Active Flight Plan, touch **FPL Source** > **Internal** if an external navigator is configured.
- 2) Press the **MENU** Key.
- 3) Touch **Save Flight Plan**.

## 6.4 FLIGHT PLAN ACTIVATION USING THE G3X TOUCH

Activating a stored flight plan erases the active flight plan and replaces it with a copy of the flight plan being activated. Inverting a stored flight plan reverses the waypoint order, erases the active flight plan, and replaces it with the flight plan being activated (the stored flight plan is not changed).

### Activating a stored flight plan:

- 1) Press the **MENU** Key twice.
- 2) Touch **FPL List**.
- 3) Touch the desired flight plan.
- 4) Press the **MENU** Key.
- 5) Touch **Activate Flight Plan**.
- 6) Touch **Yes**.

### Activating a Flight Plan Leg:

- 1) From the Active Flight Plan, touch **FPL Source** > **Internal** if an external navigator is configured.
- 2) Touch the waypoint leg to be activated.
- 3) Press the **Direct-to** Key.
- 4) If an external navigator is configured, touch **FPL Source** > **Internal**.
- 5) Touch **Activate**.

## 6.5 FLIGHT PLAN EDITING

### ADDING WAYPOINTS TO AN EXISTING FLIGHT PLAN

Waypoints can be added to the active flight plan or any stored flight plan. Choose the flight plan, select the desired point of insertion, enter the waypoint, and it is added in front of the selected waypoint. Flight plans are limited to 300 waypoints (including approach waypoints).

#### Adding a waypoint to a flight plan:

- 1) With a flight plan displayed, touch **FPL Source** > **Internal** if an external navigator is configured (Active Flight Plan only).
- 2) Touch the point in the flight plan to add the new waypoint. The new waypoint is placed directly in front of the selected waypoint.
- 3) Touch **Insert Waypoint**.
- 4) Enter the waypoint using the keypad.

**Or:**

Touch **Find** > **Search Name** > **Search by Facility Name**. Enter the facility name using the keypad.

**Or:**

Touch **Find** > **Search City** > **Search by City**. Enter the city name using the keypad.

**Or:**

Touch **Find** > **Recent** Tab.

**Or:**

Touch **Find** > **Nearest Airports** Tab.

**Or:**

Touch **Find** > **Flight Plan** Tab.

**Or:**

Touch **Find** > **User** Tab.

- 5) Touch **Enter**.

### Adding a waypoint to a flight plan using the map:

- 1) With a flight plan displayed, touch **FPL Source** > **Internal** if an external navigator is configured (Active Flight Plan only).
- 2) Press **Menu**.
- 3) Touch **Edit on Map**.
- 4) Touch the desired leg on the map.
- 5) With the flight plan leg selected, touch the waypoint to insert. If multiple waypoints are available at the selected location, they are displayed in boxes next to the selected location.
- 6) Touch **Save**.

## EDITING FLIGHT PLAN SPEED, FUEL, AND/OR NAME



**NOTE:** If a fuel flow sensor is configured, the user-entered 'Plan Fuel' value is used while on the ground. In the air, the 'Plan Fuel' field is hidden and the fuel calculations are based on the actual measured fuel flow.

### Adjusting the Active Flight Plan fuel:

- 1) From the Active Flight Plan, touch **FPL Source** > **Internal** if an external navigator is configured.
- 2) Touch **Plan Fuel**.
- 3) Enter the desired value using the keypad and touch **Enter**.

Plan Fuel	Leg DTK	Leg Dist
7.0		
<b>KCRQ</b> MC Clellan Palomar	---	---
<b>KSBA</b> Santa Barbara Mun	290 <sup>M</sup>	150 <sup>m</sup>
Add Waypoint		
<b>Total</b>		150 <sup>m</sup>

Plan Fuel

### Adjusting the Saved Flight Plan speed and fuel:

- 1) Press the **MENU** Key twice.
- 2) Touch **FPL List**.
- 3) Touch the desired saved flight plan.
- 4) Touch **Plan Fuel**.
- 5) Enter the desired value using the keypad and touch **Enter**.
- 6) Touch **Plan Speed**.
- 7) Enter the desired value using the keypad and touch **Enter**.

### Editing the Saved Flight Plan Name:

- 1) Press the **MENU** Key twice.
- 2) Touch **FPL List**.
- 3) Touch the desired saved flight plan.
- 4) Touch **Edit**.
- 5) Press the **MENU** Key.
- 6) Touch the **Name** field.
- 7) Enter the desired name using the keypad and touch **Enter**.

**Or:**

- 5) Touch the name field at the top of the window.
- 6) Enter the desired name using the keypad and touch **Enter**.

## COPYING FLIGHT PLANS

The G3X Touch allows copying a flight plan into a new flight plan memory slot, allowing editing, etc., without affecting the original flight plan. This can be used to duplicate an existing stored flight plan for use in creating a modified version of the original stored flight plan.

### Copying a stored flight plan:

- 1) Press the **MENU** Key twice.
- 2) Touch **FPL List**.
- 3) Touch the desired saved flight plan to copy.
- 4) Press the **MENU** Key.
- 5) Touch **Copy Flight Plan**.

## DELETING FLIGHT PLANS

Individual or all stored flight plans can be deleted from the G3X Touch memory.

### Deleting a stored flight plan:

- 1) Press the **MENU** Key twice.
- 2) Touch **FPL List**.
- 3) Touch the desired saved flight plan to delete.
- 4) Press the **MENU** Key.
- 5) Touch **Delete Flight Plan**.
- 6) Touch **Yes**.

### Deleting all stored flight plans:

- 1) Press the **MENU** Key twice.
- 2) Touch **FPL List**.
- 3) Press the **MENU** Key.
- 4) Touch **Delete All**.
- 5) Touch **Yes**.



**NOTE:** The changes made to the active flight plan affect navigation as soon as they are entered. Editing the active flight plan does not affect any saved flight plans. Waypoints in the final approach segment (such as the FAF or MAP) can not be deleted individually.

### Deleting the Active Flight Plan:

- 1) From the Active Flight Plan, touch **FPL Source** > **Internal** if an external navigator is configured.
- 2) Press the **MENU** Key.
- 3) Touch **Stop Navigation**.

### Deleting an individual waypoint from the active flight plan:

- 1) From the Active Flight Plan, touch **FPL Source** > **Internal** if an external navigator is configured.
- 2) Touch the desired waypoint to delete.
- 3) Touch **Remove Waypoint**.
- 4) Touch **Yes**.

### Deleting an individual waypoint from a saved flight plan:

- 1) Press the **MENU** Key twice.
- 2) Touch **FPL List**.
- 3) Touch the desired saved flight plan.
- 4) Touch the desired waypoint to delete.
- 5) Touch **Remove Waypoint**.
- 6) Touch **Yes**.

## INVERTING A FLIGHT PLAN

Any flight plan may be inverted (reversed) for navigation back to the original departure point.

### Inverting the active flight plan:

- 1) From the Active Flight Plan, touch **FPL Source** > **Internal** if an external navigator is configured.
- 2) Press the **MENU** Key.
- 3) Touch **Invert Flight Plan**.

### Inverting a saved flight plan:

- 1) Press the **MENU** Key twice.
- 2) Touch **FPL List**.
- 3) Touch the desired saved flight plan.
- 4) Press the **Menu** Key.
- 5) Touch **Invert Flight Plan**.

## IMPORTING/EXPORTING FLIGHT PLANS

### Importing flight plans:

- 1) Press the **MENU** Key twice.
- 2) Touch **FPL List**.
- 3) Press the **Menu** Key.
- 4) Touch **Import Flight Plan**.

### Exporting flight plans:

- 1) Press the **MENU** Key twice.
- 2) Touch **FPL List**.
- 3) Touch the desired saved flight plan.
- 4) Press the **Menu** Key.
- 5) Touch **Export Flight Plan**.

## 6.6 APPROACHES (WITHOUT EXTERNAL NAVIGATOR CONFIGURED)



**WARNING:** Do not use the approach information provided by the VFR navigation database residing within the G3X Touch as a means of navigating any instrument approach. The G3X Touch VFR navigation database is limited to present only the waypoints for the final approach leg of a published procedure. These waypoints and associated course line are made available for monitoring purposes only.



**NOTE:** This section is not applicable if an external GPS navigator is configured. Approach configuration is handled via the external GPS navigator's controls only. Refer to the external GPS navigator's Pilot's Guide for more information.

An approach can be loaded at any airport that has one available, and provides situational awareness for non-precision and precision approaches to airports with published instrument approach procedures. Only one approach can be loaded at a time in a flight plan. If an approach is loaded when another approach is already in the active flight plan, the new approach replaces the previous approach.

Whenever an approach is selected, the choice to either "Load Approach" or "Activate Approach" is given. "Load Approach" adds the approach to the end of the flight plan without immediately using it for navigation guidance. This allows continued navigation via the intermediate waypoints in the original flight plan, but keeps the procedure available on the Active Flight Plan Page for quick activation when needed. "Activate Approach" also adds the procedure to the end of the flight plan but immediately begins to navigate to the first waypoint in the approach.



## SELECTING AN APPROACH

When selecting an approach, it replaces the destination airport with the sequence of waypoints for the selected approach. Keep in mind that the airport must have a published approach (GPS, RNAV, VOR, NDB, localizer, or ILS) and only the final course segment (final approach fix to missed approach point) of the published approach is available (unless an external navigator is configured).

An approach can be selected from the Direct-to Window, Waypoint (WPT) Page, Active Flight Plan Page, and the Saved Flight Plan Page.

### Loading an approach from the saved flight plan page:

- 1) Press the **MENU** Key Twice.
- 2) Touch **FPL List**.
- 3) Touch the desired saved flight plan.
- 4) Press the **MENU** Key.
- 5) Touch **Select Approach**.
- 6) Touch  to view a list of approaches.
- 7) Touch the desired approach.
- 8) Touch **Select Approach**.

### Loading an approach from the active flight plan page:

- 1) From the Active Flight Plan, touch **FPL Source** > **Internal** if an external navigator is configured.
- 2) Press the **MENU** Key.
- 3) Touch **Select Approach**.
- 4) Touch  to view a list of approaches.
- 5) Touch the desired approach.
- 6) Touch **Load Approach**.

### Viewing a chart for the selected approach:

- 1) Press the **MENU** Key Twice.
- 2) Touch **Wpt**.
- 3) Touch **TERPs**.

**Activating an approach on the Active Flight Plan Page:**

- 1) From the Active Flight Plan, touch **FPL Source** > **Internal** if an external navigator is configured.
- 2) Touch any leg of the loaded approach.
- 3) Touch **Activate Approach**.

**Loading/Activating an approach from the Direct-to Window:**

- 1) Press the **Direct-to** Key.
- 2) Press the **MENU** Key.
- 3) Touch **Select Approach**.
- 4) If necessary, touch the identifier name.
- 5) Enter the identifier and touch **Enter**.
- 6) Touch  to view a list of approaches.
- 7) Touch the desired approach.
- 8) Touch **Activate Approach**.

**Removing an approach from the Active Flight Plan:**

- 1) From the Active Flight Plan, touch **FPL Source** > **Internal** if an external navigator is configured.
- 2) Press the **MENU** Key.
- 3) Touch **Remove Approach**.

## ACTIVATING VECTORS-TO-FINAL

After an approach has been activated, Activate Vectors-to-Final is used when being vectored to the final approach course by Air Traffic Control (ATC).

The G3X Touch creates an extension of the final course, beyond the final approach waypoint in the database (final approach fix [FAF]). On the Active Flight Plan Page, a Vector to Final symbol appears beside the first approach waypoint.



Vectors-to-Final



Vectors-to-Final

The G3X Touch does not provide guidance to the inbound course. The course deviation needle on the graphic HSI remains off-center until established on the final approach course. The map shows an extension of the final approach course using a bold magenta line.

If Activate Vectors-to-Final is not selected, the G3X Touch creates a straight-line course directly to the first waypoint in the approach.

Loading the approach cancels the Direct-to and initiates a route to the FAF.

### Activating Vectors-to-Final:

- 1) From the Active Flight Plan, touch **FPL Source** > **Internal** if an external navigator is configured.
- 2) With an approach loaded in the Active Flight Plan, touch any leg of the approach.
- 3) Touch **Activate Vectors-to-Final**.

### Cancelling Vectors-to-Final:

- 1) From the Active Flight Plan, touch **FPL Source** > **Internal** if an external navigator is configured.
- 2) With Vectors-to-Final activated, press the **MENU** Key.
- 3) Touch **Cancel Vectors-to-Final**.

## SECTION 7 HAZARD AVOIDANCE

### 7.1 WEATHER INFORMATION

#### WEATHER SOURCE

On installations that include the capability to receive both SiriusXM and FIS-B (through GDL® 39) weather information, there are three options available for selection through the Main Menu or Weather Page; AUTO, SXM (SiriusXM), and GDL FIS-B. The default selection is 'AUTO.' With AUTO selected, and a SiriusXM subscription, SiriusXM weather information is displayed. If SiriusXM service is unavailable with AUTO selected, FIS-B weather information is displayed, if available. If either SiriusXM or GDL FIS-B source is selected, only the selected source is used to display weather information and no automatic source-switching will occur. Data from the selected weather source will apply to all weather shown on the Map Page, Waypoint Page, Weather Page, Nearest Page, and configurable data fields.

#### Switching Weather Sources:

- 1) Press the **MENU** Key twice.
- 2) Touch **Setup > Weather**.
- 3) Touch the Weather Data Source.
- 4) Touch **Auto, SiriusXM, or GDL FIS-B**.

**Or**

- 1) From the Weather Page, press the **MENU** Key.
- 2) Touch **Data Source**.
- 3) Touch **Auto, SiriusXM, or GDL FIS-B**.

## DATA LINK WEATHER (OPTIONAL)



**NOTE:** See the G3X Touch Installation Manual for Data Link Weather activation instructions.



**NOTE:** Data Link Weather is only available with the optional GDU 465 or GDU 455.

## DATA LINK WEATHER ADVISORY

Each time the system powers-up, the pilot is prompted to acknowledge a Data link weather advisory.



Data link Weather Advisory

Touch **Press To Accept**.

## USING DATA LINK WEATHER PRODUCTS



**WARNING:** Do not use data link weather information for maneuvering in, near, or around areas of hazardous weather. Information contained within data link weather products may not accurately depict current weather conditions.



**WARNING:** Do not use the indicated data link weather product age to determine the age of the weather information shown by the data link weather product. Due to time delays inherent in gathering and processing weather data for data link transmission, the weather information shown by the data link weather product may be significantly older than the indicated weather product age.

Data Link Weather Products can be displayed on the Map Page and individually on the Weather (Wx) Page.

### FIS-B

The GDL 39/39R is a receive-only data link radio with on-board GPS, 978 MHz (the Universal Access Transceiver frequency band), and 1090 MHz Extended Squitter (1090 ES) receivers. It is designed to receive, process, and output traffic (ADS-B air-to-air, and TIS-B traffic information), and weather (Flight Information Service-Broadcast (FIS-B)) information to the G3X Touch system through an RS-232 serial connection. As a UAT receiver, the GDL 39/39R can receive and, when connected to the G3X Touch, display Flight Information Service-Broadcast (FIS-B) weather products as well as traffic.

FIS-B is a subscription-free weather service that is broadcast by Ground Based Transceivers (GBTs) over the 978 MHz UAT frequency band as part of the FAA's Next Generation Air Transportation System (NextGen). To receive FIS-B weather information, the GDL 39/39R must be within range and line-of-sight of an operating GBT. Reception may be affected by altitude, terrain, and other factors. GDL 39/39R-supported FIS-B weather products include METARs, TAFs, NEXRAD (Regional and CONUS (Combined)), AIRMETs, SIGMETs, PIREPs, and Winds and Temperatures Aloft. Other products include NOTAMs and TFRs. Only one display in a multiply-display installation may be configured to show FIS-B weather information. It is recommended that the GDL 39/39R be connected to the MFD in a multiple-display system.

## FIS-B EXPIRATION TIME

FIS-B weather broadcasts are updated regularly and may take approximately ten minutes to transmit all available weather data. Therefore, weather data is not immediately available. No pilot action is required to receive FIS-B weather information. Weather product status can be viewed on the dedicated Weather Page, or the Data Link Page from the Tools menu.

When a FIS-B weather product is active on a map, the age of the data is displayed on the screen in the lower left corner. The age of the product is based on the time difference between when the data was assembled on the ground and the current GPS time. Weather products are broadcast at specific intervals (see broadcast interval in the table below).

If, for any reason, a weather product is not refreshed within the Expiration Time intervals (see table), the data is considered expired and is removed from the display. This ensures that only data that is consistent with FIS-B broadcast data is displayed. If more than half of the expiration time has elapsed, the color of the product age displayed changes to yellow. The system displays dashes instead of a product age when a product has expired. If a weather product is not available or has not been received, the system displays 'N/A' instead of a product age.

The table below shows the FIS-B weather expiration time and the broadcast interval. The broadcast interval represents the interval at which FIS-B GBTs broadcast new signals that may or may not contain new weather data. It does not represent the rate at which weather data is updated or new content is received by the GDL 39/39R.

FIS-B Products	Expiration Time	Update Interval (Minutes)	Broadcast Interval (Minutes)
NEXRAD Composite Reflectivity (CONUS)	60 minutes	~5 minutes precipitation mode 10 minutes for clear air	15
NEXRAD Composite Reflectivity (Regional)	60 minutes	As Available	2.5
METAR	8 hours	1 minute (where available), As Available otherwise	5



FIS-B Products	Expiration Time	Update Interval (Minutes)	Broadcast Interval (Minutes)
TAF	12 hours	8 hours	10
AIRMET	12 hours	As Available	5
SIGMET	12 hours	As Available, then at 15 minute intervals for 1 hour	5
PIREP	8 hours	As Available	10
Winds and Temperatures Aloft	12 hours	12 hours	10
NOTAM (D)/FDC (Including TFRs)	12 hours	As Available	10

### Weather Product Timing

#### Viewing Ground Station Status:

- 1) Press the **MENU** Key twice to display the Main Menu.
- 2) Touch Data Link.
- 3) Press the **MENU** Key.
- 4) Touch **Ground Stations**.

## SIRIUSXM

Before SiriusXM Weather can be used, the service must be activated. Service is activated by providing SiriusXM Satellite Radio with a Radio ID.

SiriusXM Satellite Radio uses the Radio ID to send an activation signal that allows the G3X Touch to display weather data and/or entertainment programming.

### SXM Weather Information

- Radio ID—Eight-digit ID number used for activation.
- Service Level—SiriusXM Weather subscription plan purchased.
- Weather Products—List of weather features and age of weather data in minutes.

## Accessing Data Link Weather information:

From the Weather (Wx) Page or SiriusXM (SXM) Page, press the **MENU** Key and touch **More Info....**

### DATA LINK WEATHER SETUP

The setup menu for the Map Page controls the map range settings above which weather products are decluttered from the display. If a map range larger than the weather product map range setting is selected, the weather product data is removed from the map. For weather products such as Lightning, and Storm Cells, the weather product is displayed when a map range "smaller" than the weather product map range setting is selected (Satellite Mosaic works inversely). The menu also provides a means for enabling/disabling display of 'Airmets', 'Sigmets', 'Weather Data', 'NEXRAD', and/or 'Fronts' on the Map Page.

Additional information about the following can be displayed by touching the item on the Weather Page or the Map Page:

- Storm Cells
- SIGMETs
- AIRMETs
- METARs
- TFRs

### Viewing Data Link Weather products on the Map Page:

- 1) From the Map Page, press the **MENU** Key.
- 2) Touch Weather.
- 3) Touch the desired weather product on the map.
- 4) With the weather product selected, touch the Map Feature Button to display additional information.

### Viewing Data Link Weather products on the Weather (Wx) Page:

- 1) From the Wx Page, touch the desired weather product on the map.
- 2) With the weather product selected, touch the Map Feature Button to display additional information.

### Setting up and customizing weather data for the Map Page:

- 1) From the Map Page press the **MENU** Key.
- 2) Touch **Set Up Map**.
- 3) Scroll the tabs left or right if necessary.
- 4) Touch the **Weather Tab**.
- 5) Touch  to view a list of options (**On, Off, Auto, range settings**).
- 6) Touch the desired option for each weather product.

### Restoring default weather data for the Map Page:

- 1) From the Map Page press the **MENU** Key.
- 2) Touch **Set Up Map**.
- 3) Touch the **Weather Tab**.
- 4) Press the **MENU** Key.
- 5) Touch **Restore Category Defaults**.

### Viewing legends for displayed weather products:

- 1) From the Map Page or the Wx Page, press the **MENU** Key.
- 2) Touch **Weather Legend**.
- 3) Touch  to cycle through the weather products.

### Animating weather:

- 1) From the Map Page or the Wx Page, press the **MENU** Key.
- 2) Touch **Animate Weather**.

## WEATHER PRODUCTS

Weather Product	SiriusXM Weather (products vary by subscription)	GDL 39/39R FIS-B Weather (Subscription-free)
NEXRAD Radar (CONUS) Base and Composite Reflectivity	+	
NEXRAD Radar (CONUS low resolution)		+
NEXRAD Radar (Regional high resolution)		+
NEXRAD Radar (Canada)	+	
Satellite Mosaic	+	
Surface Precipitation	+	
Surface Analysis	+	
Sea Surface Temperatures	+	
Echo Tops	+	
Surface Pressure	+	
Lightning	+	
Storm Cells	+	
METAR (US)	+	+
METAR (Canada)	+	
TAF (US)	+	+
TAF (Canada)	+	
AIRMET	+	+
SIGMET	+	+
PIREP	+	+
Winds Aloft	+	+
Temperatures Aloft		+
NOTAMs		+
Temporary Flight Restrictions	+	+

- System Overview
- Flight Instruments
- EIS
- CNS Interface
- GPS Navigation
- Flight Planning
- Hazard Avoidance**
- Additional Features
- AFCs
- Annun/Alerts
- Appendix
- Index

Weather Product	SiriusXM Weather (products vary by subscription)	GDL 39/39R FIS-B Weather (Subscription-free)
Freezing Level	+	
Turbulence Forecast	+	
Icing Forecast	+	
City Forecast	+	

### Supported Weather Products by Source

## NEXRAD

NEXRAD (NEXt-generation RADar), is a network of multiple high-resolution Doppler radar sites that are operated by the National Weather Service (NWS). NEXRAD data provides centralized meteorological information for the continental United States and selected overseas locations. The maximum range of a single NEXRAD radar site is 250 nm. In addition to a wide array of services, the NEXRAD network provides important information about severe weather and air traffic safety.

NEXRAD data is not real-time. The lapsed time between collection, processing, and dissemination of NEXRAD images can be significant and may not reflect the current radar synopsis. Due to the inherent delays and the relative age of the data, it should be used for long-range planning purposes only. Never use NEXRAD data or any radar data to penetrate hazardous weather. Rather, use it in an early-warning capacity of pre-departure and enroute evaluation.

Composite data from all the NEXRAD radar sites in the United States is shown. This data is composed of the maximum reflectivity from the individual radar sweeps. The display of the information is color-coded to indicate the weather severity level.

The display of radar coverage is always active when NEXRAD is selected. Areas where NEXRAD radar coverage is not currently available or is not being collected are indicated in grayish-purple. Radar capability exists in these areas, but it is not active or is off-line.

## NEXRAD Abnormalities

There are possible abnormalities regarding displayed NEXRAD images. Some, but not all, of those include:

- Ground clutter
- Strokes and spurious radar data
- Sun strokes, when the radar antenna points directly at the sun
- Military aircraft deploy metallic dust (chaff) which can cause alterations in radar scans
- Interference from buildings or mountains, which may cause shadows

## NEXRAD Limitations

Certain limitations exist regarding the NEXRAD radar displays. Some, but not all, are listed for the user's awareness:

- NEXRAD base reflectivity does not provide sufficient information to determine cloud layers or precipitation characteristics (hail vs. rain). For example, it is not possible to distinguish between wet snow, wet hail, and rain.
- NEXRAD base reflectivity is sampled at the minimum antenna elevation angle. An individual NEXRAD site cannot depict high altitude storms at close ranges, and has no information about storms directly over the site.
- Radar coverage only extends to 55°N.
- Any precipitation displayed between 52°N and 55°N is unknown.

## Reflectivity

Reflectivity is the amount of transmitted power returned to the radar receiver. Colors on the NEXRAD display directly correlate to the level of detected reflectivity. Reflectivity as it relates to hazardous weather can be very complex. The role of radar is essentially to detect moisture in the atmosphere. Simply put, certain types of weather reflect radar better than others. The intensity of a radar reflection is not necessarily an indication of the weather hazard level. For instance, wet hail returns a strong radar reflection, while dry hail does not. Both wet and dry hail can be extremely hazardous.

The different NEXRAD echo intensities are measured in decibels (dB) relative to reflectivity (Z). NEXRAD measures the radar reflectivity ratio, or the energy reflected back to the radar receiver (designated by the letter Z). The value of Z increases as the returned signal strength increases.

### NEXRAD Intensity

Colors are used to identify the different NEXRAD echo intensities (reflectivity) measured in dBZ (decibels of Z). "Reflectivity" (designated by the letter Z) is the amount of transmitted power returned to the radar receiver. The dBZ values increase as returned signal strength increases. Precipitation intensity is displayed using colors corresponding to the dBZ values.

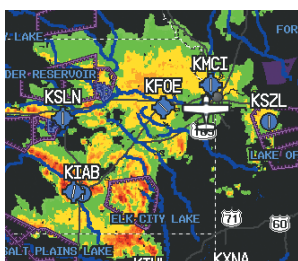

NEXRAD Data

### FIS-B Radar Products

FIS-B weather provides two different Radar products, CONUS and Regional. The system can display each individually or a composite (COMBINED). When Regional Radar is displayed, only precipitation for your current region is displayed. The subdued (grayish-purple colored) area represents the area not covered by the regional radar product. When Combined radar data is viewed, Regional Radar data is displayed on top of CONUS data and the time shown in the lower left corner is associated with Regional Radar data only.



FIS-B Radar (Combined)

## SATELLITE MOSAIC

Satellite Mosaic displays infrared composite images of cloud cover taken by geostationary weather satellites. The Satellite Mosaic provides up to seven levels of cloud cover.

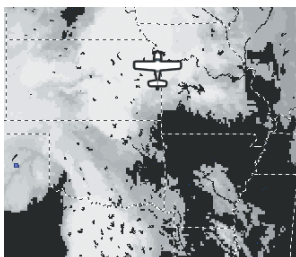

Satellite Mosaic Data

## ECHO TOPS

Echo Tops are derived from NEXRAD radar and indicate the highest altitude at which precipitation is falling. Echo Tops at or above the altitude you select are displayed, in 5,000 foot increments up to 70,000 ft. Echo Tops can be helpful in determining the severity of thunderstorms.



Echo Tops Data

System Overview

Flight Instruments

EIS

CNS Interface

GPS Navigation

Flight Planning

Hazard Avoidance

Additional Features

AFCs

Annun/Alerts

Appendix

Index



## WINDS ALOFT

Winds Aloft data shows the forecasted wind speed and direction at the surface and at selected altitudes. Altitudes can be displayed in 3,000-foot increments up to 42,000 feet MSL.

Winds Aloft are displayed using wind barbs or a wind streamline depending on the selected range. The wind barbs indicate wind speed and direction. The wind streamline indicates wind direction with arrows.

The wind barbs always point in the direction that the wind is coming from. The wind speed is depicted using flags at the end of the wind barb. A short wind flag is 5 knots, a long wind flag is 10 knots, and a triangle flag is 50 knots.

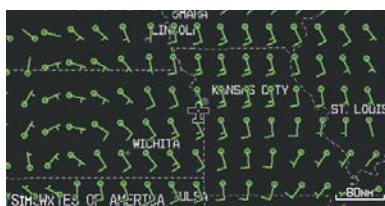

**Winds Aloft Data**

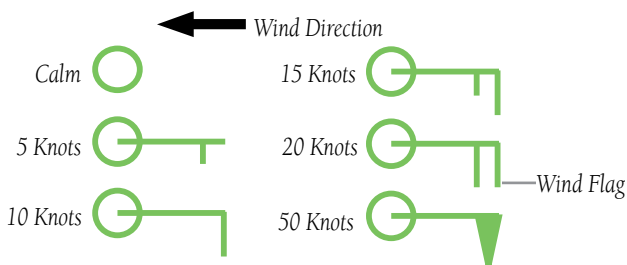

**Winds Barbs**

## SURFACE PRESSURE

This feature displays pressure isobars and pressure centers. The isobars connect points of equal pressure. Pressure readings can help determine weather and wind conditions. High pressure areas are generally associated with fair weather. Low pressure areas are generally associated with clouds and the chance of precipitation. Isobars that are packed closely together show a strong pressure gradient. Strong gradients are associated with areas of stronger winds. Pressure units can be displayed in Millibars (mb) and Inches of Mercury (in).

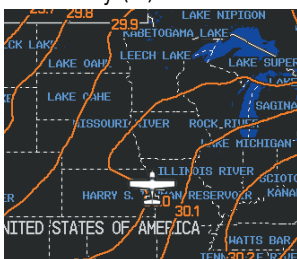

Surface Pressure Data

## LIGHTNING

Lightning data shows the approximate location of cloud-to-ground lightning strikes. A strike icon represents a strike that has occurred within a two-kilometer region and within the last seven minutes. The exact location of the lightning strike is not displayed.



Lightning Data

## STORM CELLS

The Storm Cells feature displays storms as well as the storm's projected path in the immediate future.

The direction of the storm is displays by an arrow (at a range of 20 nm or less). The tip of the arrow indicates where the storm should be in 15 minutes. Critical information about the storm cell (tops and intensity) can be viewed by touching the storm cell.



Storm Cell Data

## METARs AND TAFs



**NOTE:** METAR information is only displayed within the installed aviation database service area.

METAR (METeorological Aerodrome Report) is an international code used for reporting weather observations. METARs are updated hourly or as needed. METARs typically contain information about the temperature, dewpoint, wind, precipitation, cloud cover, cloud heights, visibility, and barometric pressure. They can also contain information on precipitation amounts, lightning, and other critical data. If METAR data is available for an airport, a color-coded flag is shown next to the airport.

TAF (Terminal Area Forecast) is the standard format for 24-hour weather forecasts. TAFs may contain some of the same code as METAR data. It typically forecasts significant weather changes, temporary changes, probable changes, and expected changes in weather conditions.

METAR and TAF text data is displayed on the Map Page and the Weather (WX) Page. An abbreviated version can be viewed by touching the METAR flag. Touching the identifier name displays additional information.

The METAR flag color is determined by the information in the METAR text.

- System Overview
- Flight Instruments
- EIS
- CNS Interface
- GPS Navigation
- Flight Planning
- Hazard Avoidance
- Additional Features
- AFCs
- Annun/Alerts
- Appendix
- Index



VFR (ceiling greater than 3000 feet AGL and visibility greater than 5 miles)



Marginal VFR (ceiling 1000-3000 feet AGL and/or visibility 3-5 miles)



IFR (ceiling 500 to below 1000 feet AGL and/or visibility 1 mile to less than 3 miles)



Low IFR (ceiling below 500 feet AGL or visibility less than 1 mile)



METAR text does not contain adequate information to determine flight conditions

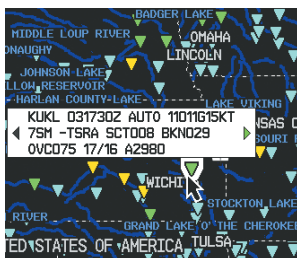

METAR Selected

## AIRMETS

An AIRMET (AIRmen’s METeological Information) can be especially helpful for pilots of light aircraft that have limited flight capability or instrumentation. An AIRMET must affect or be forecast to affect an area of at least 3,000 square miles at any one time. AIRMETS are routinely issued for six-hour periods and are amended as necessary due to changing weather conditions. AIRMETS are displayed as colored, dashed lines.

## SIGMETs

A SIGMET (SIGnificant METeological Information) advises of weather that is potentially hazardous to all aircraft. In the contiguous United States, the following items are covered: severe icing, severe or extreme turbulence, volcanic ash, dust storms, and sandstorms that lower visibility to less than three statute miles.

A Convective SIGMET is issued for the following conditions: thunderstorms, isolated severe thunderstorms, embedded thunderstorms, hail at the surface, and tornadoes.

A SIGMET is widespread and must affect or be forecast to affect an area of at least 3,000 square miles. SIGMETs are displayed as a yellow-dashed line.

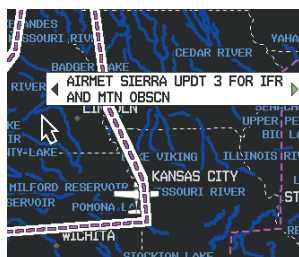

AIRMET Selected

### TEMPORARY FLIGHT RESTRICTIONS (TFR)



**NOTE:** Do not rely solely upon data link services to provide Temporary Flight Restriction (TFR) information. Always confirm TFR information through official sources such as Flight Service Stations or Air Traffic Control.

Temporary Flight Restrictions, or TFRs, temporarily restrict all aircraft from entering the selected airspace unless a waiver has been issued. TFRs are routinely issued for activities such as sporting events, dignitary visits, military depots, and forest fires. TFRs are represented as an area highlighted by red (active) or yellow (not yet active).



TFR Data

## PIREPs

Pilot Weather Reports (PIREPs) provide timely weather information for a particular route of flight. When significant weather conditions are reported or forecast, Air Traffic Control (ATC) facilities are required to solicit PIREPs. A PIREP may contain unforecast adverse weather conditions, such as low in-flight visibility, icing conditions, wind shear, and turbulence. PIREPs are issued as either Routine (UA) (blue) or Urgent (UUA) (yellow).



PIREP Data

## FREEZING LEVELS

Freezing Level shows contours for the lowest forecast altitude where icing conditions are likely to occur.

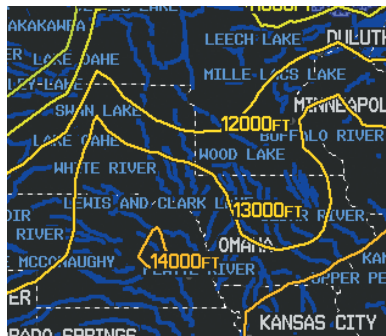

Freezing Level Data

## TURBULENCE FORECAST

Turbulence data identifies the potential for erratic movement of high-altitude air mass associated winds. Turbulence is classified as light, moderate, severe, or extreme. Turbulence data is intended to supplement AIRMETs and SIGMETs.



**Severe Turbulence Selected**

## ICING FORECAST (CIP & SLD)

Current Icing Product (CIP) data shows a graphical view of the current icing environment. Icing severity is displayed in four categories: light, moderate, severe, and extreme (not specific to aircraft type). The CIP product is not a forecast, but a representation of the current conditions at the time of the analysis.

Supercooled Large Droplet (SLD) icing conditions are characterized by the presence of relatively large, super cooled water droplets indicative of freezing drizzle and freezing rain aloft. SLD threat areas are depicted as magenta dots over the CIP colors.

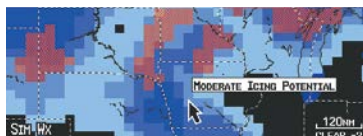

**Moderate Icing Selected**

## FORECAST

Forecast information is available for current and forecast weather conditions. Forecasts are available for intervals of 12, 24, 36, and 48 hours.



Forecast Data



Forecast Legend

## 7.2 TERRAIN



**WARNING:** Do not use Terrain information for primary terrain avoidance. Terrain information is intended only to enhance situational awareness.



**NOTE:** Terrain data is not displayed when the aircraft is outside the installed terrain database coverage area.



**NOTE:** Terrain depicted in the Profile View is always “ahead” of the aircraft, and will change as ground track changes.



The Terrain Page displays altitudes of terrain and obstructions relative to the aircraft position and altitude with reference to a database that may contain inaccuracies. Terrain and obstructions are shown only if they are in the database. Terrain and obstacle information should be used as an aid to situational awareness. They should never be used to navigate or maneuver around terrain.

Note that all obstructions may not be available in the terrain and obstacle database. No terrain and obstacle information is shown without a valid 3-D GPS position.

The G3X Touch GPS receiver provides the horizontal position and altitude of the aircraft. Aircraft GPS altitude is derived from satellite position. GPS altitude is then converted to a mean sea level (MSL)-based altitude (GPS-MSL altitude) and is used to determine terrain and obstacle proximity. GPS-MSL altitude accuracy is affected by satellite geometry, but is not subject to variations in pressure and temperature that normally affect pressure altitude sensors. GPS-MSL altitude does not require local altimeter settings to determine MSL altitude. It is a widely-used MSL altitude source.

Terrain and obstacle databases are referenced to MSL. Using the GPS position and altitude, the Terrain feature portrays a 2-D picture of the surrounding terrain and obstacles relative to the position and altitude of the aircraft. GPS position and GPS-MSL altitude are used to calculate and predict the aircraft's flight path in relation to the surrounding terrain and obstacles. In this way, the pilot can view predicted dangerous terrain and obstacle conditions.

Alert windows appear on all pages (except the Terrain (Ter) Page) to inform the pilot of proximity to the terrain and obstacles, as well as an unsafe descent rate. These alerts depend on user-defined parameters in the Terrain Page setup.

## SYNTHETIC VISION

Terrain is integrated within Synthetic Vision (when active) to provide land contours (colors are consistent with those of the topographical map display), large water features, towers, obstacles over 200' AGL, as well as visual and auditory alerts to indicate the presence of terrain and obstacle threats relevant to the projected flight path. Synthetic Vision terrain information is displayed in red and yellow shading on the PFD. Refer to section 8.1 (Synthetic Vision) for more information.

## TERRAIN INFORMATION

The areas of the terrain shaded red are predicted to be within 100 feet below or above the aircraft. The yellow terrain areas are between the user-defined Caution Elevation and 100 feet below the aircraft. By default, the Caution Elevation is 1,000 feet; therefore, the areas in yellow are between 1,000 feet and 100 feet below the aircraft. The black areas are further than the Caution Elevation. A projected point of impact is marked with an "X" symbol.

### Enabling/Disabling Terrain Shading on the Map Page:

From the Map Page, press **MENU**, then touch **TERRAIN**.

## TERRAIN VIEWS

Two views are displayed on the Terrain (Ter) Page: the Map View, and the Profile View.

Yellow Terrain is Between the User-defined Caution Elevation and 100 ft Below the Aircraft  
Map View

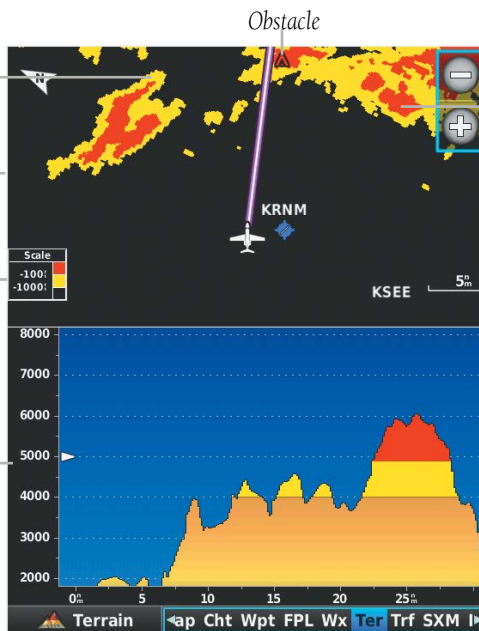

Red Terrain is above the aircraft, or within 100 ft below the aircraft.

Terrain (Ter) Page



**NOTE:** When on the ground, the terrain color scale changes so no yellow is shown, and the red band starts at 400 feet above the aircraft. This allows the pilot to quickly identify threatening terrain while on the ground. After the aircraft is airborne, the terrain display reverts to normal.

## OBSTACLE INFORMATION

Obstacles are shown on the Terrain Page at or below the map range of 12 nm. Obstacles are also shown on the Map Page when the map range is set to 3 nm or below.

Standard aeronautical chart symbols are used for lighted or unlighted obstacles taller than 200 feet Above Ground Level (AGL). Refer to the Obstacle Icons legend below.

Each obstacle is labeled with the altitude of the top of the obstacle, or Mean Sea Level (MSL). Each obstacle also lists, in parentheses, the actual height of the obstacle, or Above Ground Level (AGL).

Unlighted Obstacle		Lighted Obstacle		Potential Impact Points	Obstacle Location
< 1000' AGL	> 1000' AGL	< 1000' AGL	> 1000' AGL		
					WARNING: Red obstacle is above or within 100' below current aircraft altitude
					CAUTION: Yellow obstacle is between 100' and 1000' (default) below current aircraft altitude

Terrain Obstacle Colors and Symbology

## TERRAIN SETTINGS

Use the terrain settings to set levels for terrain alerts as well as obstacles in or near your flight path.

- **Caution Elevation**—The G3X Touch will provide an alert if the terrain or obstacle is within the default Caution Elevation or user-defined Caution Elevation.
- **Look Ahead Time**—Determines the maximum time when an alert annunciation occurs. For example, if 120 seconds is selected, the G3X Touch provides an alert up to 120 seconds before you reach the terrain or obstacle.
- **Alert Sensitivity**—The three Alert Sensitivity settings (Terrain, Obstacle, and Descent Rate) determine what level of alerts are annunciated. The G3X Touch defaults to 'High' sensitivity, which annunciates all red and yellow alerts at the time set in Look Ahead Time. 'Medium' sensitivity annunciates all of the red and the highest priority of yellow alerts. 'Low' only annunciates red alerts. 'Off' disables the alert.

### Accessing the terrain settings:

- 1) From the Terrain Page, press the **MENU** Key.
- 2) Touch **Caution Elevation** and touch **500ft Below**, **750ft Below**, or **1000ft Below**.

**Or:**

Touch **Look Ahead Time** and touch **60 Seconds**, **90 Seconds**, or **120 Seconds**.

**Or:**

Touch **Terrain**, **Obstacles**, or **Descent Rate** and touch **Off**, **Low**, **Medium**, or **High**.

**Or:**

Touch **Alerts** to toggle between **Enabled** and **Inhibited**.

**Or:**

Touch **Profile View** to toggle on and off.

## TERRAIN ALERTS

Terrain, Obstacle, and Descent Rate Alerts are issued when flight conditions meet parameters that are set within the software algorithms. Terrain alerts typically employ a CAUTION or a WARNING alert severity level, or both. When an alert is issued, visual annunciations are displayed and aural alerts are simultaneously issued. When the aircraft descends through 500 feet above the destination airport an audible “Five Hundred” altitude reminder occurs.

If the Terrain Page is not displayed, a pop-up alert appears in the lower left corner of the page. The Range Rings on the pop-up alert are spaced every whole mile/kilometer/nautical mile. Touch the alert to acknowledge the pop-up and/or aural alert.

Terrain and obstacle annunciations appear on the PFD in the upper left corner of the Attitude Indicator. Arrows are depicted on the terrain and obstacle annunciations if terrain is outside the Synthetic Vision field of view.

*Arrows indicate the terrain is outside the Synthetic Vision field of view.*



Terrain Annunciation on PFD

### Enabling/Disabling terrain alerts:

- 1) From the Terrain Page, press the **MENU** Key.
- 2) Touch **Alerts** to toggle between **Enabled** and **Inhibited**.

## AURAL ALERTS

- “Five Hundred”—when the aircraft descends through 500 feet above the destination airport.

The following aural terrain alerts are issued when flight conditions meet parameters that are set within the software algorithms, and are dependent on the sensitivity level set in the Terrain Setup Menu.

Alert Severity	Terrain	Obstacle	Descent Rate
<b>Caution</b>	“caution, terrain” “caution, terrain ahead”	“caution, obstacle” “caution, obstacle ahead”	“caution, sink rate”
<b>Warning</b>	“terrain ahead! pull up!” “terrain! terrain! pull up! pull up!”	“obstacle ahead! pull up!” “obstacle! obstacle! pull up! pull up!”	“sink rate, pull up!” “pull up!”

**Aural Alerts Summary**

- System Overview
- Flight Instruments
- EIS
- CNS Interface
- GPS Navigation
- Flight Planning
- Hazard Avoidance
- Additional Features
- AFCs
- Annun/Alerts
- Appendix
- Index



PFD Terrain Alert



MFD Terrain Alerts

## 7.3 TRAFFIC SYSTEMS

### TRAFFIC SOURCE

The G3X Touch is compatible with three different traffic sources; TIS-A traffic via a Garmin Mode S Transponder (GTX 33, GTX 330 or GTX 23), TAS via a GTS 800, or ADS-B/TIS-B traffic via a GDL 39/39R. When the G3X Touch system is configured with both a Mode S transponder capable of receiving TIS-A traffic and a GDL 39/39R capable of receiving ADS-B/TIS-B traffic the G3X Touch will automatically switch between traffic sources. The following conditions describe the traffic display logic.

- If the GTX is not receiving TIS-A traffic data, GDL 39/39R ADS-B traffic will be displayed.
- If the GDL 39/39R is receiving both air-to-air ADS-B traffic data and ground uplink TIS-B traffic, then the GDL 39/39R ADS-B traffic will be displayed.
- If the GTX is receiving TIS-A traffic, and the GDL 39/39R is not receiving ground uplink TIS-B traffic, then GTX TIS-A traffic will be displayed.

System Overview

Flight Instruments

EIS

CNS Interface

GPS Navigation

Flight Planning

Hazard Avoidance

Additional Features

ATIS

Annun/Alerts

Appendix

Index

If more than one traffic source is configured, the current traffic source is annunciated in the upper left hand corner of the Traffic Page (TRF).

Traffic Source	Description
<b>GTX TIS-A Operating</b>	Displaying TIS-A traffic from a Mode S transponder.
<b>GDL ADS-B Operating Normal</b>	Displaying ADS-B/TIS-B traffic from a GDL 39/39R
<b>GTS TAS Operating Normal</b>	Displaying TAS traffic from a GTS 800

### Traffic Source Annunciation

## TRAFFIC PRIORITIZATION

The G3X Touch supports multiple traffic receivers and automatically prioritizes these devices.

The following are the traffic receivers in order of priority:

- GTS 800 Active Traffic System
- GDL39/39R ADS-B traffic system receiving both air-to-air and TIS-B
- GTX23ES/GTX330ES TIS-A traffic system receiving TIS-A
- GDL39/39R ADS-B traffic system receiving only air-to-air

If the GTS 800 is turned off, the system will automatically use the next available receiver according to priority.



## TRAFFIC INFORMATION SERVICE (TIS-A) (OPTIONAL)



**NOTE:** Refer to Appendix E for general information regarding Traffic Information Service (TIS-A).

The G3X Touch supports Traffic input from a Garmin Mode S transponder, such as the GTX 330 or GTX 23.

### SYSTEM STATUS

The traffic system status is annunciated in the upper right corner of the Map Page.

System Status	Traffic Icon
Operating	
No Traffic Data Available	

*If a Traffic Icon is not displayed, check the Map Page range and/or the Traffic Display Range on the Map Set Up menu.*

### Traffic Modes



### TRAFFIC SYMBOLOGY

Traffic is shown on the G3X Touch according to TCAS symbology, graphically shown on the Traffic Page (Optional), Map Page, and in the Traffic Warning Window.

A Proximity Advisory (PA) indicates that the intruding aircraft is within  $\pm 1200$  feet and is within a 5 nm range, but is still not considered a threat.

A Traffic Advisory (TA) symbol appears as a solid yellow circle. All other traffic within range is shown as a hollow white diamond. Altitude deviation from own aircraft altitude is shown above the target symbol if traffic is above own aircraft altitude, and below the symbol if they are below own aircraft altitude. Altitude trend is shown as an up arrow ( $>+500$  ft/min), down arrow ( $<-500$  ft/min), or no symbol if less than 500 ft/min rate in either direction.

- System Overview
- Flight Instruments
- EIS
- CNS Interface
- GPS Navigation
- Flight Planning
- Hazard Avoidance
- Additional Features
- AFCS
- Annun/Alerts
- Appendix
- Index

TIS-A Symbol	Description
	Non-Threat Traffic
	Proximity Advisory (PA)
	Traffic Advisory (TA)

Traffic Symbols

## TRAFFIC ANNUNCIATIONS

The G3X Touch displays traffic symbolically on the Map Page, and the Traffic Warning Window (Inset Map) in the lower left corner of the GDU 46X MFD display.

When a traffic advisory (TA) is detected, the following automatically occur:

- The Traffic Warning Window (Inset Map) is enabled and displays traffic (GDU 46X Only).
- A flashing black-on-yellow 'TRAFFIC' annunciation will appear in the upper right corner of the Attitude Indicator for five seconds and remains displayed until no TAs are detected in the area.
- A single "Traffic" voice alert is generated

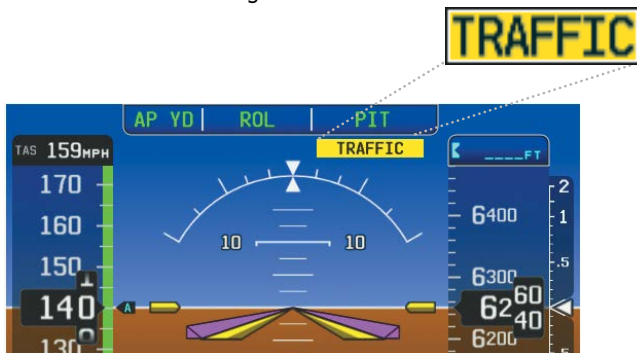

Traffic Alerts

Arrows are depicted on the traffic message if traffic is outside the Synthetic Vision field of view. The arrow points in the direction of the traffic.



**Traffic Outside the Synthetic Vision Field of View (PFD)**

## TRAFFIC VOICE ALERTS

A traffic voice alert is generated whenever the number of Traffic Advisories on the G3X Touch screen increases from one scan to the next. Limiting Traffic Advisories only reduces the “nuisance” alerting due to proximate aircraft. For example, when the first Traffic Advisories appear on the TIS-A display, the user is alerted audibly. So long as a single aircraft remains on the traffic display, no further voice alert is generated. If a second (or more) aircraft appears on the screen, a new voice alert is sounded.

If the number of Traffic Advisories on the traffic display decreases and then increases, a new voice alert is sounded. The traffic voice alert is also generated whenever traffic becomes available. The following traffic voice alerts are available:

- “Traffic”—Traffic alert received.
- “Traffic Not Available”—Traffic service is not available or out of range.

### Enable/disable traffic alerts:

- 1) Touch the Page Navigation Bar.
- 2) Touch **Traffic**.
- 3) Press the **MENU** Key.
- 4) Touch **Alerts** to toggle between **Enabled** and **Inhibited**.

## TRAFFIC WARNING WINDOW

When a traffic threat is imminent, the Traffic Warning Window is shown. The Traffic Warning Window shows a small pop-up map in the lower left corner. The Range Rings on the pop-up alert are spaced every whole mile/kilometer/nautical mile.



Traffic Warning Window



**NOTE:** The Traffic Warning Window is disabled when the aircraft ground speed is less than 30 knots or when on the approach leg of a route.

## TRAFFIC GROUND TRACK

Traffic ground track is indicated on the G3X Touch screen by a “target track vector,” a short line shown in 45-degree increments, extending in the direction of target movement.

### DISPLAYING TRAFFIC DATA

Traffic is displayed by default on the Map Page and the Traffic Warning Window.

Traffic information is also displayed on the PFD when Synthetic Vision is enabled. See the ‘Additional Features’ Section for more information.

### Displaying Traffic information:

Touch the traffic on the map to display range and altitude separation information.



Traffic (Map Page)

### Enabling/disabling traffic data on the Map Page:

- 1) From the Map Page, press the **MENU** Key.
- 2) Touch **Traffic**.

### Enabling/disabling traffic on the Synthetic Vision display:

- 1) Touch the HSI or Attitude Indicator.
- 2) Touch **More Options**.
- 3) Touch and drag to scroll down.
- 4) Touch **Traffic** to deselect it.

## DEDICATED TRAFFIC PAGE (TRF)

### Disabling/Enabling the traffic alerts:



**NOTE:** Traffic alerts are reset to 'enabled' on the next power cycle.

- 1) From the Traffic (Trf) Page, press the **MENU** Key.
- 2) Touch **Alerts** to toggle between **Inhibit** and **Enable**.

- System Overview
- Flight Instruments
- EIS
- CNS Interface
- GPS Navigation
- Flight Planning
- Hazard Avoidance
- Additional Features
- AFCs
- Annun/Alerts
- Appendix
- Index

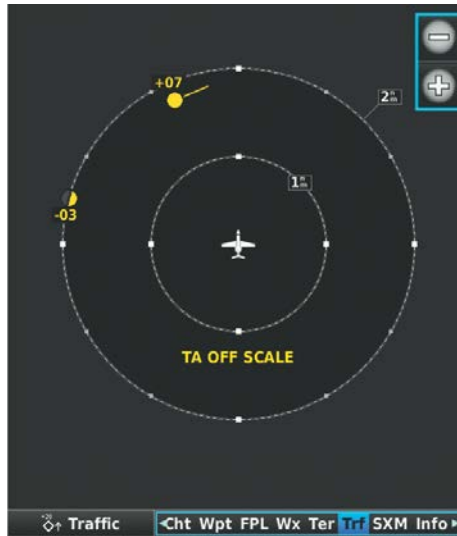

Traffic Page

## GARMIN GTS 800 TRAFFIC (OPTIONAL)



**WARNING:** Do not rely solely upon the display of traffic information for traffic avoidance maneuvering. The GTS 800 Traffic Advisory System (TAS) is intended for advisory use only to aid the pilot in visually acquiring traffic. No avoidance maneuvers should be based solely upon TAS traffic information. It is the responsibility of the pilot in command to see and maneuver to avoid traffic.



**NOTE:** Pilots should be aware of TAS system limitations. TAS systems require transponders of other aircraft to respond to system interrogations. If the transponders do not respond to interrogations due to phenomena such as antenna shading or marginal transponder performance, traffic may be displayed intermittently, or not at all. Aircraft without altitude reporting capability are shown without altitude separation data or climb descent indication. Pilots should remain vigilant for traffic at all times.



**NOTE:** TIS-A is disabled when TAS installed.

The optional Garmin GTS 800 is a Traffic Advisory System (TAS). It enhances flight crew situational awareness by displaying traffic information for transponder-equipped aircraft. The system also provides visual and aural traffic alerts including voice announcements to assist in visually acquiring traffic.

The GTS 800 is capable of tracking up to 45 intruding aircraft equipped with Mode A or C transponders, and up to 30 intruding aircraft equipped with Mode S transponders. A maximum of 30 aircraft with the highest threat potential can be displayed simultaneously. No TAS surveillance is provided for aircraft without operating transponders.

## THEORY OF OPERATION





When the GTS 800 is in Operating Mode, the unit interrogates the transponders of intruding aircraft while monitoring transponder replies. The system uses this information to derive the distance, relative bearing, and if reported, the altitude and vertical trend for each aircraft within its surveillance range. The GTS 800 then calculates a closure rate to each intruder based on the projected Closest Point of Approach (CPA). If the closure rate meets the threat criteria for a Traffic Advisory (TA), visual and aural alerting is provided.

## TAS SURVEILLANCE VOLUME

The GTS 800 surveillance system monitors the airspace within  $\pm 10,000$  feet of own altitude. Under ideal conditions, the GTS 800 unit scans transponder traffic up to 12 nm in the forward direction. The range is somewhat reduced to the sides and aft of own aircraft due to the directional interrogation signal patterns. In areas of greater transponder traffic density or when TCAS II (Traffic Alert and Collision Avoidance System II) systems are detected, the GTS 800 automatically reduces its interrogation transmitter power (and therefore range) in order to limit potential interference from other signals.

## TAS SYMBOLOGY

The GTS 800 uses symbology to depict intruding traffic using the symbols shown below.

Symbol	Description
	Traffic Advisory.
	Traffic Advisory out of the selected display range. Displayed at outer range ring at proper bearing.
	Proximity Advisory.
	Non-Threat Traffic.

### GTS 800 Traffic Symbols

A Traffic Advisory (TA), displayed as a yellow circle or triangle, alerts the crew to a potentially hazardous intruding aircraft, if the closing rate, distance, and vertical separation meet TA criteria. A Traffic Advisory that is beyond the selected display range (off scale) is indicated by a half TA symbol at the edge of the screen at the relative bearing of the intruder.

A Proximity Advisory (PA), displayed as a solid white diamond or triangle, indicates the intruding aircraft is within  $\pm 1200$  feet and is within a 6 nm range, but is still not considered a TA threat.

A Non-threat Advisory, shown as an open white diamond or triangle, is displayed for traffic beyond 6 nm that is neither a TA or PA.

Relative altitude, when available, is displayed above or below the corresponding intruder symbol in hundreds of feet. When this altitude is above own aircraft, it is preceded by a '+' symbol; a minus sign '-' indicates traffic is below own aircraft.

A vertical trend arrow to the right of the intruder symbol indicates climbing or descending traffic with an upward or downward-pointing arrow respectively.



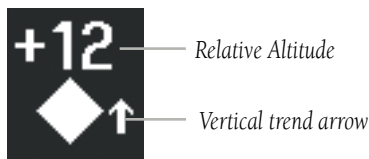

**Intruder Altitude and Vertical Trend Arrow**

Flight IDs may also be displayed with traffic symbols; see the Flight IDs discussion in this section for more information.

**TAS ALERTS**

When the GTS 800 detects a new TA, the following occur:

- A single “Traffic!” voice alert is generated, followed by additional voice information about the bearing, relative altitude, and approximate distance from the intruder that triggered the TA. The announcement “Traffic! 12 o’clock, high, four miles,” would indicate the traffic is in front of own aircraft, above own altitude, and approximately four nautical miles away.
- A TRAFFIC Annunciation appears at the top right of the airspeed on the PFD, flashing for five seconds and remains displayed until no TAs are detected in the area.

If the bearing of TA traffic cannot be determined, a yellow text banner will be displayed in the center of the Traffic Page and in the lower-left of the PFD inset map (GDU 46X only) instead of a TA symbol. The text will indicate “TA” followed by the distance, relative altitude, and vertical trend arrow for the TA traffic, if known.

Bearing	Relative Altitude	Distance (nm)
“One o’clock” through “Twelve o’clock” or “No Bearing”	“High”, “Low”, “Same Altitude” (if within 200 feet of own altitude), or “Altitude not available”	“Less than one mile”, “One Mile” through “Ten Miles”, or “More than ten miles”

**TA Descriptive Voice Announcements**

## TA ALERTING CONDITIONS

The GTS 800 automatically adjusts its TA sensitivity level to reduce the likelihood of nuisance TA alerting during flight phases likely to be near airports. The system uses Level A TA sensitivity when the groundspeed is less than 120 knots; Level B TA sensitivity applies in all other conditions.

Sensitivity Level	Intruder Altitude Available	TA Alerting Conditions
A	Yes	Intruder closing rate provides less than 20 seconds of vertical and horizontal separation. Or: Intruder closing rate provides less than 20 seconds of horizontal separation and vertical separation is within 600 feet. Or: Intruder range is within 0.2 nm and vertical separation is within 600 feet.
A	No	Intruder closing rate provides less than 15 seconds of separation.
B	No	Intruder range is less than 20 seconds.
B	Yes	Intruder closing rate provides less than 30 seconds of vertical and horizontal separation. Or: Intruder closing rate provides less than 30 seconds of horizontal separation and vertical separation is within 800 feet. Or: Intruder range is within 0.55 nm and vertical separation is within 800 feet.

**TA Sensitivity Level and TA Alerting Criteria**

- System Overview
- Flight Instruments
- EIS
- CNS Interface
- GPS Navigation
- Flight Planning
- Hazard Avoidance
- Additional Features
- AFCs
- Annun/Alerts
- Appendix
- Index

## SYSTEM TEST



**NOTE:** Traffic surveillance is not available during the system test. Use caution when performing a system test during flight.

The GTS 800 provides a system test mode to verify the TAS system is operating normally. The test takes ten seconds to complete. When the system test is initiated, a test pattern of traffic symbols is displayed on the Traffic Page. If the system test passes, the aural announcement "TAS System Test Passed" is heard, otherwise the system announces "TAS System Test Failed." When the system test is complete, the traffic system enters Standby Mode.

- 1) From the Traffic Page, touch **+** or **-** to set the range to 2/6 nm to allow the full test pattern to be displayed during test.
- 2) Press the **MENU** Key.
- 3) Touch **Self-test**.

## OPERATION



**NOTE:** The GTS 800 automatically transitions from **Standby** to **Operate** mode eight seconds after takeoff. The unit also automatically transitions from **Operate** to **Standby** mode 24 seconds after landing.

After power-up, the GTS 800 is in Standby Mode. The GTS 800 must be in Operating Mode for traffic to be displayed and for TAs to be issued.

Touching **Operate** on the Traffic Page Options Menu, allows the traffic unit to switch from Standby Mode to Operating Mode as necessary. Touching **Standby**, forces the unit into Standby Mode.

### Switching from operating mode to standby mode:

- 1) From the Traffic Page, press the **MENU** Key.
- 2) Touch **Standby**.

### Switching from standby mode to operating mode:

- 1) From the Traffic Page, press the **MENU** Key.
- 2) Touch **Operate**.

## Changing the altitude range:

- 1) From the Traffic Page, press the **MENU** Key.
- 2) Touch **Alt Mode**.
- 3) Touch one of the following:
  - **Above:** Displays non-threat and proximity traffic from 9000 feet above the aircraft to 2700 feet below the aircraft. Typically used during climb phase of flight.
  - **Normal:** Displays non-threat and proximity traffic from 2700 feet above the aircraft to 2700 feet below the aircraft. Typically used during enroute phase of flight.
  - **Below:** Displays non-threat and proximity traffic from 2700 feet above the aircraft to 9000 feet below the aircraft. Typically used during descent phase of flight.
  - **Unrest:** (unrestricted): All traffic is displayed from 9900 feet above and 9900 feet below the aircraft.

## FLIGHT ID DISPLAY

The Flight IDs of other aircraft (when available) can be enabled for display on the Traffic Page. When a flight ID is received, it will appear above or below the corresponding traffic symbol on the Traffic Page when this option is enabled.

### Enabling/Disabling Flight ID Display:

- 1) From the Traffic (Trf) Page, press the **MENU** Key.
- 2) Touch **Flight ID** to toggle the Flight ID on and off.

## TRAFFIC PAGE

The Traffic Page shows surrounding TAS traffic data in relation to the aircraft's current position and altitude, without basemap clutter. It is the primary page for viewing traffic information. Aircraft orientation is always heading up unless there is no valid heading. Map range is adjustable by touching **+** and **-**, as indicated by the map range rings.

The traffic mode and altitude display mode are annunciated in the upper left corner of the page.

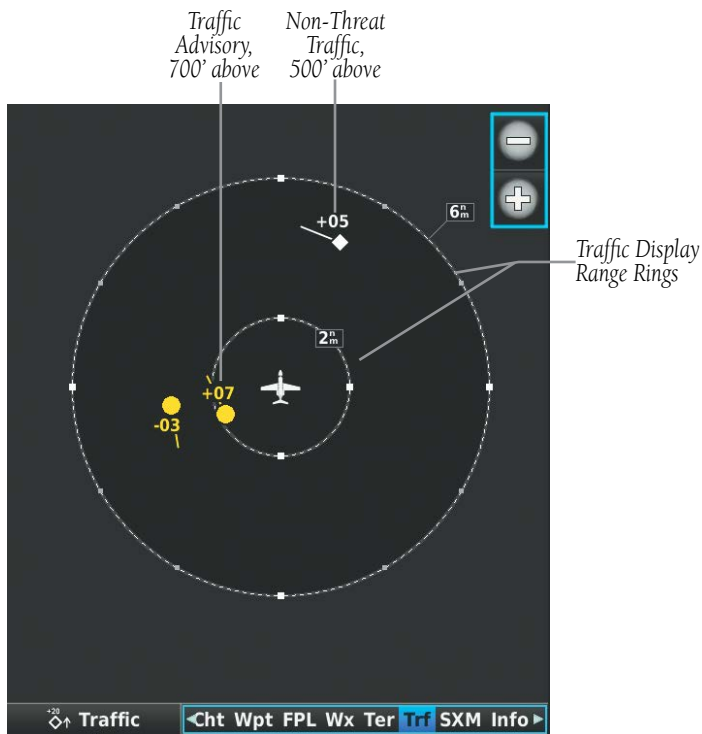

Traffic Page (GTS 800)

## DATA LINK TRAFFIC (GDL 39/39R) (OPTIONAL)

The GDL 39/39R is a receive-only data link radio with on-board GPS, 978 MHz (Universal Access Transceiver frequency band), and 1090 MHz Extended Squitter (1090 ES) receivers. It is designed to receive, process, and output traffic (ADS-B air-to-air, and TIS-B traffic information), and weather (Flight Information Service-Broadcast (FIS-B)) information to the G3X Touch system through an RS-232 serial connection or Bluetooth connection.

ADS-B (Automatic Dependent Surveillance-Broadcast) is a surveillance technology deployed across the United States as the cornerstone of the FAA’s Next Generation Air Transportation System (NextGen). ADS-B enables improved surveillance services, both air-to-air and air-to-ground, especially in areas where radar is ineffective due to terrain or where it is impractical or cost prohibitive. Initial applications of air-to-air ADS-B are for “advisory” use only, enhancing a pilot’s visual acquisition of other nearby ADS-B equipped aircraft either when airborne or on the airport surface.

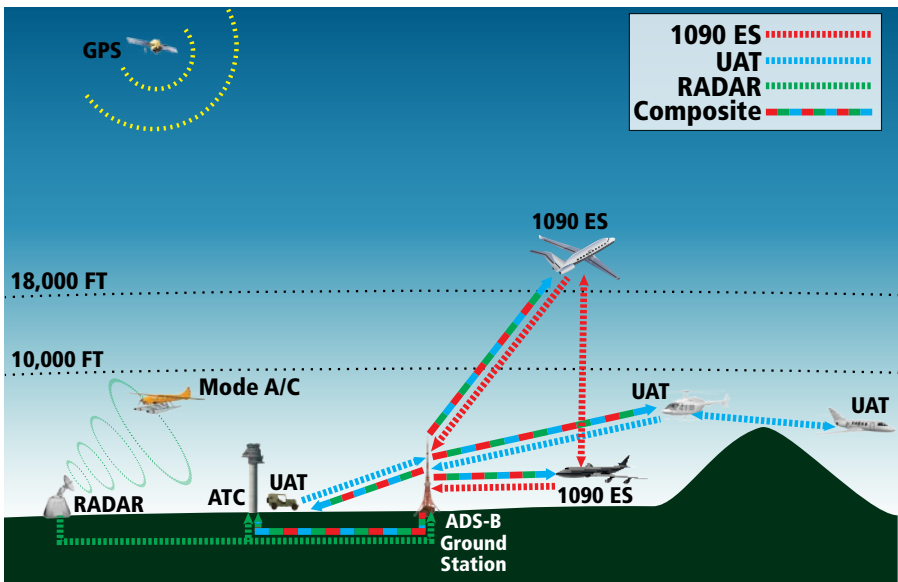

ADS-B System

For the purpose of distinguishing between levels of ADS-B service, there are three classifications of aircraft or system capability; ADS-B In, ADS-B Out, and ADS-B participating. ADS-B In refers to the capability to receive ADS-B information. ADS-B Out refers to the capability to transmit ADS-B information. ADS-B participating refers to the capability to both send and receive ADS-B information. Aircraft lacking either ADS-In, ADS-B Out, or both ADS-B capabilities may also be referred to as ADS-B non-participating aircraft.

Currently, rule-compliant ADS-B Out capability in the United States requires a TSO'ed SBAS-enabled GPS, such as a Garmin GPS 400W or similar, and one of two possible data links: 1090 ES transponder or a 978 MHz UAT. Either data link system is capable of transmitting the aircraft's position, velocity, identification, and other information every second to compatible aircraft and ground stations called Ground Based Transceivers (GBTs).

Because 1090 ES transponders and UATs operate on different frequencies, aircraft not similarly equipped cannot transmit/receive data link information directly to/from each other. Instead, operation within range of a GBT is required to receive data link information on both frequencies. The GDL 39/39R is unique in its ADS-B In capability since it can receive data link information from both 1090 ES transponders and UATs.

Thus, the GDL 39/39R receives traffic information directly from any ADS-B Out aircraft within range as well as the rebroadcast of ADS-B information from any nearby GBT. This rebroadcast is called Automatic Dependent Surveillance-Rebroadcast (ADS-R) and is automatically triggered by the detection of an ADS-B participating aircraft within the service volume of the GBT. As a 978 MHz (UAT frequency) receiver, the GDL 39/39R can receive both the Traffic Information Service-Broadcast (TIS-B) and Flight Information Service-Broadcast (FIS-B) provided in conjunction with ADS-R services when in range of a GBT.

FIS-B service is provided continuously, but ADS-R including TIS-B will only be broadcast by a GBT when an ADS-B participating aircraft is within the GBT's defined service volume. In this case, a GBT will only rebroadcast TIS-B information relative to the ADS-B participating aircraft. **Only traffic that is within 15 nm lateral and 3,500' vertical of the ADS-B participating aircraft is provided in the broadcast.** Non-participating traffic aircraft located farther than 15 nm laterally and 3,500' vertically from the participating aircraft are excluded from the information transmitted by the GBT.

TIS-B traffic information includes non-participating aircraft detected by ATC surveillance radar. As TIS-B data is derived from ATC surveillance radar data, TIS-B traffic position updates typically occur every three to thirteen seconds. **Therefore, TIS-B traffic may be displayed with degraded positional accuracy. Aircraft without operating transponders are invisible to TIS-B. Aircraft operating outside of the ATC radar coverage area are also not displayed.**

Since the GDL 39/39R is a receive-only device, even when used onboard an aircraft equipped with a qualifying GPS and 1090 ES transponder, a GBT may not identify it as an ADS-B participating aircraft. The squitter of some 1090 ES transponders, including the Garmin GTX 23ES, must be configured to communicate that the aircraft has 978 MHz receive capability in order to be identified as an ADS-B participating aircraft.



---

**WARNING:** Do not rely solely upon the display of traffic information for collision avoidance maneuvering. The traffic display does not provide collision avoidance resolution advisories and does not, under any circumstances or conditions, relieve the pilot's responsibility to see and avoid other aircraft.

---



---

**WARNING:** Do not rely solely upon the display of traffic information to accurately depict all of the traffic within range of the aircraft. Due to lack of equipment, poor signal reception, and/or inaccurate information from aircraft or ground stations, traffic may be present that is not represented on the display.

---



## Viewing the GDL 39/39R Traffic and Weather Status:

- 1) Press the **MENU** Key twice.
- 2) Touch **Data Link**.



## SYSTEM STATUS

The traffic system status is announced in the upper right corner of the Map Page as well as the lower left corner of the dedicated Traffic Page.

Traffic Icon	System Status
	<p>Full traffic services available for an ADS-B participating aircraft (ground linked TIS-B, FIS-B and ADS-R, and Air-to-Air ADS-B). If you are using the GDL 39/39R on a non-participating aircraft you may still see this when you are within the service area of any participating aircraft. As a non-participating aircraft you are only receiving TIS-B traffic information for traffic within 15 nm and 3,500' of a participating aircraft.</p>
	<p>Limited traffic services available (may be limited to Air-to-Air ADS-B)</p>
	<p>No Traffic Data Available</p>

### Traffic Modes

## TRAFFIC DESCRIPTION

ADS-B traffic operation is similar to the TAS systems discussed previously, but ADS-B adds additional symbology. The symbols used to display ADS-B traffic are shown in the table below. The traffic identifier and altitude are displayed below the traffic symbol. A small up or down arrow next to the traffic symbol indicates that the traffic is climbing or descending at a rate of at least 500 feet per minute. The vector line that extends from the traffic symbol is an indication of the intruder aircraft track. For directional traffic symbols, the arrow head points in the direction of aircraft's ground track.

Symbol	Description
	Non-threat, non-directional airborne traffic
	Non-threat directional airborne Traffic with absolute vector. Points in the direction of the aircraft track.
	Non-directional airborne Proximity Advisory (PA). Proximity Advisories are issued for any traffic within 6 nautical miles and +/- 1,200'.
	Directional airborne Proximity Advisory (PA) with absolute vector. Points in the direction of the aircraft track. Proximity Advisories are issued for any traffic within 6 nautical miles and +/- 1,200'.
	Non-directional airborne Traffic Advisory (TA)
	Non-directional off-scale airborne Traffic Advisory (TA). Displayed at outer range ring at proper bearing.
	Directional airborne Traffic Advisory (TA) with absolute vector. Points in the direction of the aircraft track.
	Directional off-scale airborne Traffic Advisory (TA). Points in the direction of the aircraft track.
	*Ground traffic without directional information. Ground traffic is only displayed when own aircraft is below 1,500 feet AGL or on the ground.
	*Directional surface traffic. Ground traffic is only displayed when own aircraft is below 1,500 feet AGL or on the ground.
	*Non-directional non-aircraft ground traffic. Ground traffic is only displayed when own aircraft is below 1,500 feet AGL or on the ground.
	*Directional non-aircraft ground traffic. Ground traffic is only displayed when own aircraft is below 1,500 feet AGL or on the ground.
*Ground traffic is only displayed on the Map Page when the aircraft is on the ground or below 1,500 feet AGL. Ground traffic is always displayed on the dedicated traffic page.	

### ADS-B Traffic Symbology



## TRAFFIC ADVISORIES (TA)

The GDL 39/39R automatically adjusts its Traffic Advisory (TA) sensitivity level to reduce the likelihood of nuisance TA alerts during various phases of flight. TAs are issued for traffic when they are predicted to be within a specified volume of airspace around your aircraft in a specified amount of time. The protected volume and time interval varies based on the current geodetic altitude and groundspeed. Thus, the protected volume of airspace increases with altitude and ground speed. Refer to the following table for details.

Altitude (Geodetic)	Look Ahead Time (sec.)	Vertical Separation (ft.)	Horizontal Separation (nm.)
Below 5,000	30	+/-850	.35
5,000-10,000	40	+/-850	.55
10,000-20,000	45	+/-850	.80
20,000-42,000	48	+/-850	1.10
Above 42,000	48	+/-1,200	1.10

### Traffic Advisories

The following Traffic symbols are displayed on the display when Synthetic Vision is installed and enabled. See the Additional Features Section for more information about Synthetic Vision.

ADS-B Symbol on the PFD (Synthetic Vision Only)	Description
	Proximity Advisory (PA)
	Traffic Advisory (TA)
	Non-threat traffic

### PFD ADS-B Symbology (Synthetic Vision Only)

## TRAFFIC ALERTS (ADS-B TIS-B)

A traffic voice alert is generated whenever the number of Traffic Advisories on the G3X Touch display increases. Limiting Traffic Advisories only reduces the “nuisance” alerting due to proximate aircraft. For example, when the first Traffic Advisories appear on the display, the user is alerted audibly. So long as a single aircraft remains on the display, no further voice alert is generated. If a second (or more) aircraft appears on the screen, a new voice alert is sounded. Traffic Advisories can only be issued when the GDL 39/39R knows its own altitude and the altitude of the intruder aircraft.

If the number of Traffic Advisories on the traffic display decreases and then increases, a new voice alert is sounded. The traffic voice alert is also generated whenever TIS-B service becomes available. The traffic voice alerts are as follows:

- “Traffic” —TIS-B/ADS-B traffic alert received.
- “Traffic Not Available” —TIS-B/ADS-B service is not available or out of range.

### Disabling/Enabling the traffic alerts:



---

**NOTE:** Traffic alerts are reset to ‘enabled’ on the next power cycle.

---

- 1) From the Traffic Page, press the **MENU** Key.
- 2) Touch **Alerts** to toggle between **Enabled** and **Inhibited**.

## TRAFFIC WARNING WINDOW

The Traffic Warning Window is shown, when the GDL 39/39R issues a traffic advisory (TA). The Traffic Warning Window shows a small pop-up map in the lower left corner. The Range Rings on the pop-up alert are spaced every whole mile/kilometer/nautical mile.

## DISPLAYING TRAFFIC DATA



Traffic is displayed by default on the Map Page and in the Traffic Warning Window. Traffic Symbol and Traffic Label (i.e., relative altitude, altitude trend and absolute motion vectors) settings selects the maximum range at which traffic labels or symbols are shown. Traffic Labels can also be turned off.

Traffic information is also displayed on the PFD when Synthetic Vision is enabled. See the ‘Additional Features’ Section for more information.

### Enabling/disabling traffic data on the Map Page:

- 1) From the Map Page, press the **MENU** Key.
- 2) Touch **Traffic**.

### Customizing traffic data on the Map Page:

- 1) From the Map Page, press the **MENU** Key.
- 2) Touch **Set Up Map**.
- 3) Touch and swipe the tabs to find the **Traffic** Tab.
- 4) Touch the **Traffic** Tab.
- 5) Touch the **Traffic Data**  to view a list of options.
- 6) Touch **On** or **Off**.
- 7) Touch the **Traffic Symbol**  to view a list of options.
- 8) Touch **Auto** or a range option.
- 9) Touch the **Traffic Label**  to view a list of options.
- 10) Touch **Off**, **Auto**, or a range.

### Enabling/disabling traffic on the Synthetic Vision display:

- 1) Touch the HSI or Attitude Indicator on the PFD.
- 2) Touch **More Options**.
- 3) Touch **Traffic** to toggle traffic on and off.

### Displaying Traffic information:

Touch the traffic on the map to display range and altitude separation information.



Traffic (Map Page)

## DEDICATED TRAFFIC PAGE (TRF)



**NOTE:** Traffic alerts and altitude filters can only be changed on the dedicated Traffic Page (Trf). If the Traffic Page (Trf) is configured off, voice alerts are enabled and the altitude filter is automatically set to 'Normal'

### Displaying/Removing the Traffic Page:

- 1) From the Traffic Page, press the **MENU** Key.
- 2) Touch the **Traffic Page**
- 3) Touch **Show** or **Hide**.

### Changing the altitude range:

- 1) From the Traffic Page, press the **MENU** Key.
- 2) Touch **Alt Mode**.
- 3) Touch one of the following:
  - **Above:** Displays non-threat and proximity traffic from 9000 feet above the aircraft to 2700 feet below the aircraft. Typically used during climb phase of flight.
  - **Normal:** Displays non-threat and proximity traffic from 2700 feet above the aircraft to 2700 feet below the aircraft. Typically used during enroute phase of flight.
  - **Below:** Displays non-threat and proximity traffic from 2700 feet above the aircraft to 9000 feet below the aircraft. Typically used during descent phase of flight.
  - **Unrest:** (unrestricted): All traffic is displayed from 9900 feet above and 9900 feet below the aircraft.



**Traffic Page (GDL 39/39R)**

### FLIGHT ID DISPLAY

The Flight IDs of other aircraft (when available) can be displayed on the Traffic Page. When a Flight ID or call sign is received, it will appear below the corresponding traffic symbol when enabled.



**Example ADS-B Traffic Symbol**

- System Overview
- Flight Instruments
- EIS
- CNS Interface
- GPS Navigation
- Flight Planning
- Hazard Avoidance
- Additional Features
- AFCS
- Annun/Alerts
- Appendix
- Index

**Enabling/Disabling Flight ID Display:**

- 1) From the Traffic Page, press the **MENU** Key.
- 2) Touch the **Flight ID**.

**MOTION VECTORS**

There are two pilot-selectable and mutually exclusive types of motion vectors, Absolute and TargetTrend, which are differentiated by color and function. Absolute vectors are white and indicate ground track as reported by the traffic. TargetTrend vectors are green and indicate the flight path and position, relative to your aircraft, at which the traffic will be after the passing of one of four predetermined look-ahead intervals. The end of the TargetTrend vector indicates the traffic's predicted location relative to your predicted location at the end of the look-ahead time. For example, if traffic is ahead of you and traveling along the same track but at a slower rate, the motion vector would point opposite of its indicated direction of flight showing that you are overtaking the traffic.

The TargetTrend look-ahead time interval is automatically adjusted from 30 seconds to five minutes and corresponds to the traffic display range setting. The greater the range setting, the longer the time interval and vice versa. Refer to the table below for more details.

Traffic Page Range Ring Settings	TargetTrend Look-ahead
.5nm to 2nm	30 seconds
2nm to 6nm	60 seconds
6nm to 12nm	2 minutes
12nm to 40nm	5 minutes

**TargetTrend Look-ahead**

Motion vector selection is made from the Traffic Page Menu by enabling/disabling TargetTrend. Absolute vectors are selected by default and are replaced when TargetTrend is enabled.

**Enabling/Disabling TargetTrend:**

- 1) From the Traffic Page, press the **MENU** Key.
- 2) Touch the **TargetTrend**.



### TARGETTREND ON MAP

In addition to the Traffic Page, the Map Page can show TargetTrend vectors of nearby traffic. These indications are overlaid on top of regular topographic maps and VFR/IFR charts, showing how nearby traffic relates to surrounding waypoints, airspaces and ground features.



TargetTrend Overlaid on Moving Map

### Enabling/Disabling TargetTrend Overlay:

- 1) With the Map Page displayed, press the **MENU** Key.
- 2) Touch **Set Up Map**.
- 3) Under the 'Traffic' Tab, touch and drag to scroll to the **TargetTrend** field.
- 4) Touch **On** or **Off**.

- System Overview
- Flight Instruments
- EIS
- CNS Interface
- GPS Navigation
- Flight Planning
- Hazard Avoidance**
- Additional Features
- AFCS
- Annun/Alerts
- Appendix
- Index

Blank Page

## SECTION 8 ADDITIONAL FEATURES



**NOTE:** With the availability of SafeTaxi, FliteCharts, and ChartView in electronic form, it is still advisable to carry another source of charts on board the aircraft.

Additional features of the system include the following:

- Synthetic Vision (SVX)
- SafeTaxi®
- ChartView and FliteCharts® electronic charts
- Airport Directory Data (AOPA , AC-U-KWIK, etc.)
- SiriusXM Radio entertainment (Optional)
- Electronic Checklists (Optional)
- Flight Data Logging

Synthetic Vision provides a three-dimensional forward view of terrain features on the PFD. Synthetic Vision imagery shows the pilot's view of relevant features in relation to the aircraft attitude, as well as the flight path pertaining to the active flight plan.

SafeTaxi diagrams provide detailed taxiway, runway, and ramp information at more than 1000 airports in the United States.

ChartView and FlightCharts provide on-board electronic terminal procedure charts. Electronic charts offer the convenience of rapid access to essential information. Either ChartView or FliteCharts may be used at one time, but not both. For example, if ChartView is on the SD Card and FliteCharts is on the system's internal memory, ChartView will always take precedence (FliteCharts may be used once the SD Card containing ChartView is ejected).

The Airport Directory contains airport statistics such as pattern altitudes, noise abatement information, FBO phone numbers, hours of operation, local attractions, ground transportation, lodging, and services.

The optional SiriusXM Radio entertainment audio feature offers more than 170 channels of music, news, and sports.

Optional checklists help to quickly find the proper procedure on the ground or during flight.

The Flight Data Logging feature automatically stores critical flight and engine data on an SD data card. A 2 GB SD card can store over 1,000 hours of flight data or up to 1,000 files (whichever comes first).

## 8.1 SYNTHETIC VISION (SVX)



**WARNING:** Use appropriate primary systems for navigation, and for terrain, obstacle, and traffic avoidance. Synthetic Vision is intended as an aid to situational awareness only and may not provide either the accuracy or reliability upon which to solely base decisions and/or plan maneuvers to avoid terrain, obstacles, or traffic.

Synthetic Vision is a visual enhancement to the G3X Touch. Synthetic Vision depicts a forward-looking attitude display of the topography immediately in front of the aircraft. Synthetic Vision information is shown on the Primary Flight Display (PFD). The depicted imagery is derived from the aircraft attitude, heading, GPS three-dimensional position, and databases of terrain, obstacles, and other relevant features. Loss of any of the required data, including temporary loss of the GPS signal, will cause Synthetic Vision to be disabled until the required data is restored.

The Synthetic Vision terrain display shows land contours (colors are consistent with those of the topographical map display), large water features, towers, and other obstacles over 200' AGL that are included in the obstacle database. Cultural features on the ground such as roads, highways, railroad tracks, cities, and state boundaries are not displayed even if those features are found on the Navigation Map. The terrain display also includes a north-south east-west grid with lines oriented with true north.

Terrain is integrated within Synthetic Vision to provide visual and auditory alerts to indicate the presence of terrain and obstacle threats relevant to the projected flight path. Terrain alerts are displayed in red and yellow shading on the PFD.

The terrain display is intended for situational awareness only. It may not provide the accuracy or fidelity on which to base decisions and plan maneuvers to avoid terrain or obstacles. Navigation must not be predicated solely upon the use of the terrain or obstacle data displayed by Synthetic Vision.

The following Synthetic Vision enhancements appear on the PFD:

- Pathways
- Flight Path Marker
- Traffic Display
- Airport Signs
- Runway Display
- Terrain Alerting
- Obstacle Alerting
- Zero-Pitch Line

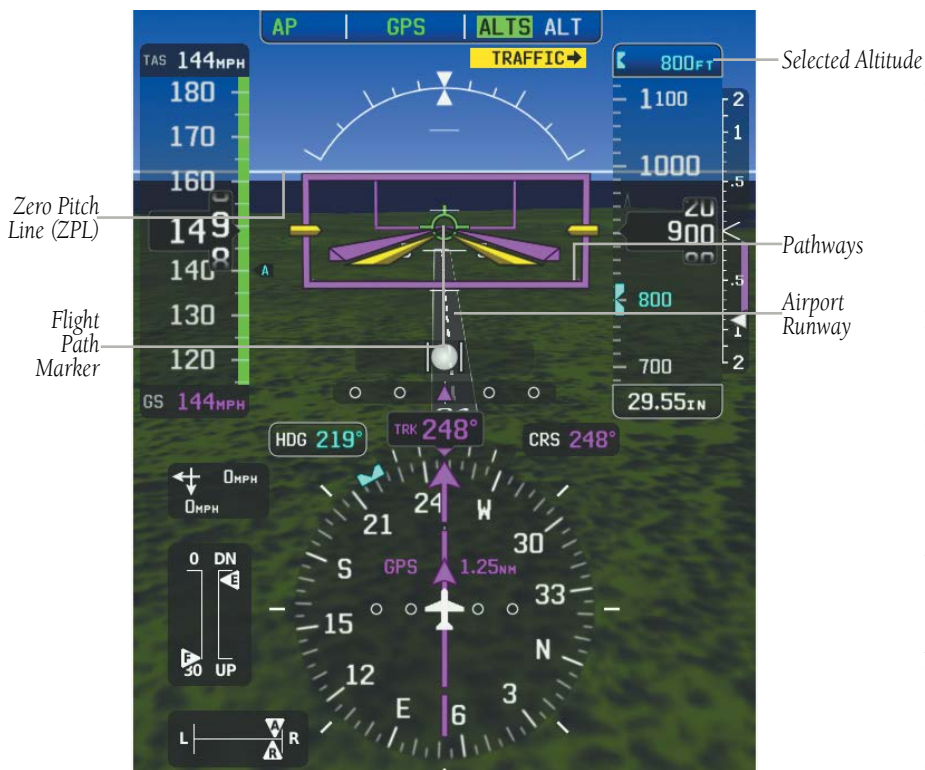

Synthetic Vision

## SYNTHETIC VISION OPERATION

Synthetic Vision is activated from the PFD Setup Page. When Synthetic Vision is enabled, the pitch scale increments are reduced.

### Activating and deactivating synthetic vision:

- 1) Touch the Attitude Indicator or HSI to display the PFD Options.
- 2) Touch **More Options**.
- 3) Touch and drag to scroll down.
- 4) Touch **Synthetic Vision** to toggle on and off.

## PATHWAYS



**NOTE:** Pathways and terrain features are not a substitute for standard course and altitude deviation information provided by the CDI, VSI, and VDI.



**NOTE:** Pathways boxes may not be displayed for holding patterns, procedure turns and certain portions of the flight plan being received from an external GPS navigator.

Pathways provide a three-dimensional perspective view of the selected route of flight shown as colored rectangular boxes representing the horizontal and vertical flight path of the active flight plan. The box size represents 700 feet wide by 200 feet tall during enroute, oceanic, and terminal flight phases. During an approach, the box width is 700 feet or one half full scale deviation on the HSI, whichever is less. Other than the descending portion of an ILS or WAAS GPS approach (starting from the leg leading into the FAF), pathways boxes are shown at the level of the altitude bug.

The color of the rectangular boxes may be magenta, green, or white depending on the route of flight and navigation source selected. The active GPS or GPS overlay flight plan leg is represented by magenta boxes that correspond to the Magenta CDI. A localizer course is represented by green boxes that correspond to a green CDI. An inactive leg of an active flight plan is represented by white boxes corresponding to a white line drawn on the Navigation Map indicating an inactive leg.

Pathways provide supplemental glidepath information on an active ILS, LPV, LNAV/VNAV, and some LNAV approaches. Pathways are intended as an aid to situational awareness and should not be used independent of the CDI, VDI, glide path indicator, and glide slope indicator. They are removed from the display when the selected navigation information is not available. Pathways are not displayed beyond the active leg when leg sequencing is suspended and are not displayed on any portion of the flight plan leg that would lead to intercepting a leg in the wrong direction.

### Activating and deactivating pathways:

- 1) Touch the Attitude Indicator or HSI to display the PFD Options.
- 2) Touch **More Options**.
- 3) Touch and drag to scroll down.
- 4) Touch **Pathways** to toggle on and off.

## DEPARTURE AND ENROUTE

Prior to intercepting an active flight plan leg, pathways are displayed as a series of boxes with pointers at each corner that point in the direction of the active waypoint. Pathways are not displayed for the first leg of the flight plan if that segment is a Heading-to-Altitude leg. The first segment displaying pathways is the first active GPS leg or active leg with a GPS overlay. If this leg of the flight plan route is outside the SVX field of view, pathways will not be visible until the aircraft has turned toward this leg. While approaching the center of the active leg and prescribed altitude, the number of pathway boxes decreases to a minimum of four.

Pathways are displayed along the flight plan route at the selected altitude for the leg. Climb profiles cannot be displayed due to the variables associated with aircraft performance. Flight plan legs requiring a climb are indicated by pathways displayed at a level above the aircraft at the altitude selected.

## DESCENT AND APPROACH



**NOTE:** During the final segment of an ILS or WAAS GPS approach, the pathways boxes automatically adjust to correspond with the localizer/glideslope (ILS) or horizontal/vertical (GPS) deviation signals received from the external navigator.

When an approach providing vertical guidance is activated, Pathways are shown level at the selected altitude. Pathways are shown level at the selected altitude up to the point along the final approach course where the altitude intercepts the extended vertical descent path or glideslope. From the vertical path descent or glideslope intercept point, the pathways are shown inbound to the Missed Approach Point (MAP) along the published lateral and vertical descent path.

During an ILS approach, the initial approach segment is displayed in magenta at the segment altitudes if GPS is selected as the navigation source on the CDI. When switching to the localizer inbound with LOC selected as the navigation source on the CDI, pathways are displayed in green along the localizer and glideslope.

If GPS is the selected navigation source on the HSI, the pathways boxes are magenta. If LOC is the selected navigation source on the HSI, the pathways boxes are green for the ILS. Pathways boxes are not displayed for segments such as heading legs or VOR radials.



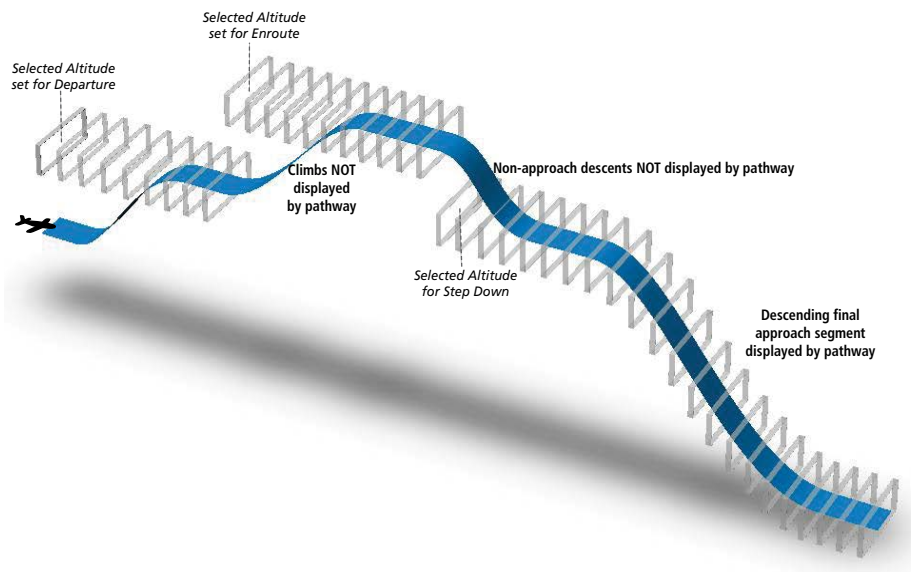

Pathways - Enroute, Descent, and Approach

**MISSED APPROACH**

Pathways are displayed at the selected altitude upon activating the missed approach on the external GPS navigator.

- System Overview
- Flight Instruments
- EIS
- CNS Interface
- GPS Navigation
- Flight Planning
- Hazard Avoidance
- Additional Features**
- AFCs
- Annun/Alerts
- Appendix
- Index

## FLIGHT PATH MARKER

The Flight Path Marker (FPM), also known as a Velocity Vector, is displayed on the PFD at groundspeeds above 30 knots. The FPM depicts the approximate projected path of the aircraft accounting for wind speed and direction relative to the three-dimensional terrain display.

The FPM is always available when the Synthetic Vision feature is in operation. The FPM represents the direction of the flight path as it relates to the terrain and obstacles on the display, while the airplane symbol represents the aircraft heading.

The FPM may be used to identify a possible conflict with the aircraft flight path and distant terrain or obstacles. Displayed terrain or obstacles in the aircraft's flight path extending above the FPM could indicate a potential conflict, even before a terrain alert is issued. However, decisions regarding terrain and/or obstacle avoidance should not be made using only the FPM.

### Activating and deactivating the flight path marker:

- 1) Touch the Attitude Indicator or HSI to display the PFD Options.
- 2) Touch **More Options**.
- 3) Touch and drag to scroll down.
- 4) Touch **Flt. Path Marker** to toggle the flight path marker on and off.

## ZERO PITCH LINE

The Zero Pitch Line is drawn completely across the display and represents the aircraft attitude with respect to the horizon. It may not align with the terrain horizon, particularly when the terrain is mountainous or when the aircraft is flown at high altitudes.

### TRAFFIC



**WARNING:** Intruder aircraft at or below 500 ft. AGL may not appear on the Synthetic Vision display or may appear as a partial symbol.

Traffic symbols are displayed in their approximate locations. Traffic symbols are displayed in three dimensions, appearing larger as they are getting closer, and smaller when they are further away. Traffic within 250 feet laterally of the aircraft will not be displayed on the Synthetic Vision display. Traffic symbols and coloring are consistent with that used for traffic displayed on the Inset Map or Map Page. If the traffic altitude is unknown, the traffic will not be displayed on the Synthetic Vision display. For more details refer to the Traffic Information Service (TIS-A) discussion in the Hazard Avoidance section. Arrows are depicted on the traffic message if traffic is outside the Synthetic Vision field of view.

#### Enabling/disabling traffic on the Synthetic Vision display:

- 1) Touch the Attitude Indicator or HSI to display the PFD Options.
- 2) Touch **More Options**.
- 3) Touch and drag to scroll down.
- 4) Touch **Traffic** to toggle synthetic vision traffic on and off.

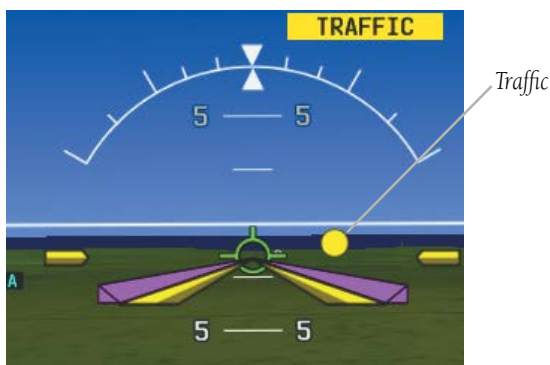

Synthetic Vision Traffic

## AIRPORT SIGNS

Airport Signs provide a visual representation of airport location and identification on the synthetic vision display. Airport Signs appear on the display when the aircraft is approximately 15 nm from an airport and disappear at approximately 4.5 nm. Airport signs are shown without the identifier until the aircraft is approximately eight nautical miles from the airport.

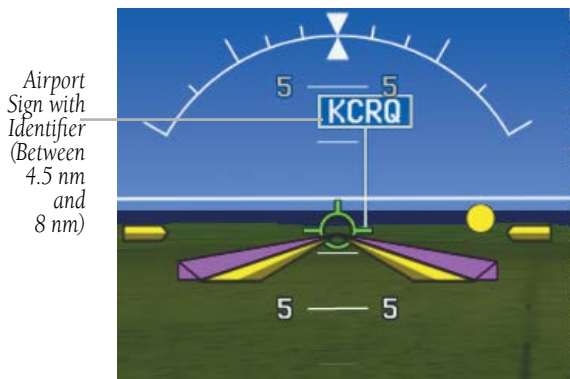

Airport Signs

System Overview

Flight Instruments

EIS

CNS Interface

GPS Navigation

Flight Planning

Hazard Avoidance

Additional Features

AFCS

Annun/Alerts

Appendix

Index

## RUNWAYS



**WARNING:** Do not use Synthetic Vision runway depictions as the sole means for determining the proximity of the aircraft to the runway or for maintaining the proper approach path angle during landing.



**NOTE:** Not all airports have runways with endpoint data in the database, therefore, these runways are not displayed.

Runway data provides improved awareness of runway location with respect to the surrounding terrain. All runway thresholds are depicted at their respective elevations as defined in the database. In some situations, where threshold elevations differ significantly, crossing runways may appear to be layered. As runways are displayed, those within 45 degrees of the aircraft heading are outlined in white. Other runways (those NOT aligned with the aircraft heading) are outlined in gray. When an approach for a specific runway is active, that runway appears brighter and is outlined with a white box, regardless of the runway orientation as related to aircraft heading. As the aircraft gets closer to the runway, more detail such as runway numbers and centerlines are displayed.

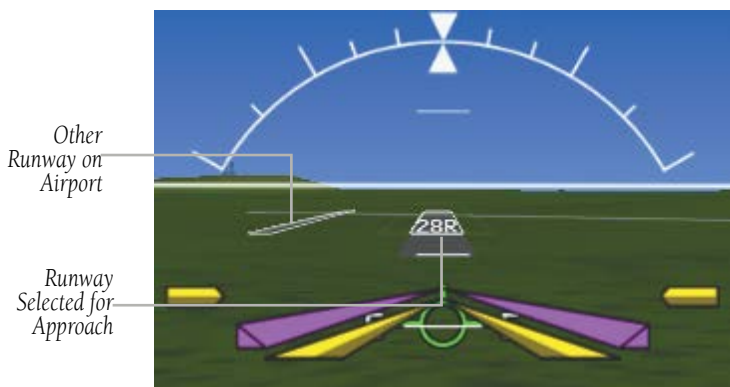

Airport Runways

## SYNTHETIC VISION TERRAIN AND OBSTACLE DATA

Terrain alerting on the synthetic vision display corresponds to the red and yellow X symbols on the Inset Map (GDU 46X only) and Navigation Map. For more detailed information regarding Synthetic Vision Terrain and Obstacle Data, refer to the Hazard Avoidance Section.

In some instances, a terrain or obstacle alert may be issued with no conflict shading displayed on the synthetic vision. In these cases, the conflict is outside the Synthetic Vision field of view and the alert will have arrows indicating the direction of the alert.



PFD Terrain Alert



MFD Terrain Alerts

Obstacles are represented on the synthetic vision display by standard two-dimensional tower symbols found on the Inset Map (GDU 46X Only) and Navigation Map. Obstacle symbols appear in the perspective view with relative height above terrain and distance from the aircraft. Unlike the Inset Map and Navigation Map display, obstacles on the synthetic vision display do not change colors to warn of potential conflict with the aircraft's flight path until the obstacle is associated with an actual terrain alert. Obstacles greater than 1000 feet below the aircraft altitude are not shown. Obstacles are shown behind the airspeed and altitude displays.

Arrows indicate the obstacle is outside the Synthetic Vision field of view.



**Obstacle Outside the Synthetic Vision Field of View**



**Synthetic Vision Obstacle Alerts**

During unusual attitude conditions or when the terrain gradient is great enough to completely fill the display, a brown (earth) or blue (sky) colored bar at the top or bottom of the screen is displayed to prevent the pilot from losing sight of the horizon.



**Blue Sky Bar with Full Display Terrain**

## SYNTHETIC VISION FIELD OF VIEW

The PFD field of view can be represented on the MFD Navigation Map Page. Two dashed lines forming a V-shape in front of the aircraft symbol on the map, represent the forward viewing area shown on the PFD.

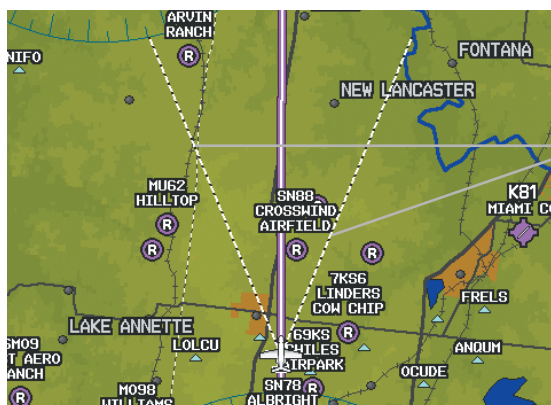

Synthetic Vision Field of View

### Configuring field of view:

- 1) From the Map Page press the **MENU** Key.
- 2) Touch **Set Up Map**.
- 3) Touch and drag the tabs to scroll.
- 4) Touch the **Miscellaneous** Tab.
- 5) Touch the **Field of View** .
- 6) Touch **On** or **Off**.



## 8.2 SAFETAXI®

SafeTaxi is an enhanced feature that gives greater map detail when viewing airports at close range. When viewing at ranges close enough to show the airport detail, the map reveals taxiways with identifying letters/numbers, runway incursion “Hot Spots”, and airport landmarks including ramps, buildings, control towers, and other prominent features. Resolution is greater at lower map ranges. The SafeTaxi feature can be seen on the Map Page and the Waypoint Page

Designated Hot Spots are recognized at airports with many intersecting taxiways and runways, and/or complex ramp areas. Airport Hot Spots are outlined to caution pilots of areas on an airport surface where positional awareness confusion or runway incursions happen most often. Hot Spots are defined by a red shaded area.

During ground operations the aircraft’s position is displayed in reference to taxiways, runways, and airport features. When panning over the airport, features such as runway holding lines and taxiways are shown at the cursor.



SafeTaxi Depiction on the Map Page

### Enabling/disabling SafeTaxi:

- 1) From the Map Page press the **MENU** Key.
- 2) Touch **Set Up Map**.
- 3) Touch and drag the tabs to scroll.
- 4) Touch the **Airport** Tab.
- 5) Touch and drag to scroll down
- 6) Touch the **SafeTaxi** .
- 7) Touch **On** or **Off**.

## SAFETAXI CYCLE NUMBER AND REVISION

SafeTaxi database is revised every 56 days. SafeTaxi is always available for use after the expiration date. The Power-up Page indicates whether the databases are current, out of date, or not available. The Power-up Page shows the SafeTaxi database is current when the SafeTaxi Expires date is shown in white. When the SafeTaxi cycle has expired, the SafeTaxi Expires date appears in yellow.

The SafeTaxi Region, Version, Cycle, Effective date, and Expiration date of the database cycle can also be found in the Main Menu, under 'Database Information'.

The SafeTaxi database is provided by Garmin. Refer to Appendix C for instructions on updating the SafeTaxi database.

## 8.3 CHARTVIEW



**WARNING:** Do not use the approach information provided by the VFR navigation database residing within the G3X Touch as a means of navigating any instrument approach. The G3X Touch VFR navigation database is limited to present only the waypoints for the final approach leg of a published procedure. These waypoints and associated course line are made available for monitoring purposes only.

ChartView resembles the paper version of Jeppesen terminal procedure charts. The MFD depiction displays the aircraft position on the moving map in the plan view of the approach charts and on airport diagrams.

ChartView database is revised every 14 days. Charts are still viewable during a period that extends from the cycle expiration date to the disables date. ChartView is disabled 70 days after the expiration date and is no longer available for viewing. When turning on the system, the Power-up Page displays the current status of the ChartView database.

The ChartView database subscription is available from Jeppesen, Inc. Available data includes:

- Arrivals (STAR)
- Departure Procedures (DP)
- Approaches
- Airport Diagrams
- NOTAMS

The geo-referenced aircraft position is indicated by an aircraft symbol displayed on the chart when the current position is within the boundaries of the chart. Inset boxes are not considered within the chart boundaries. Therefore, when the aircraft symbol reaches a chart boundary line, or inset box, the aircraft symbol is removed from the display.

The figure below, shows examples of off-scale areas, indicated by the grey shading. Note, the grey shading is for illustrative purposes only and will not appear on the published chart or display. These off-scale areas appear on the chart to convey supplemental information. However, the depicted geographical position of this information, as it relates to the chart planview, is not the actual geographic position. Therefore, when the aircraft symbol appears within one of these areas, the aircraft position indicated is relative to the chart planview, not to the off-scale area.

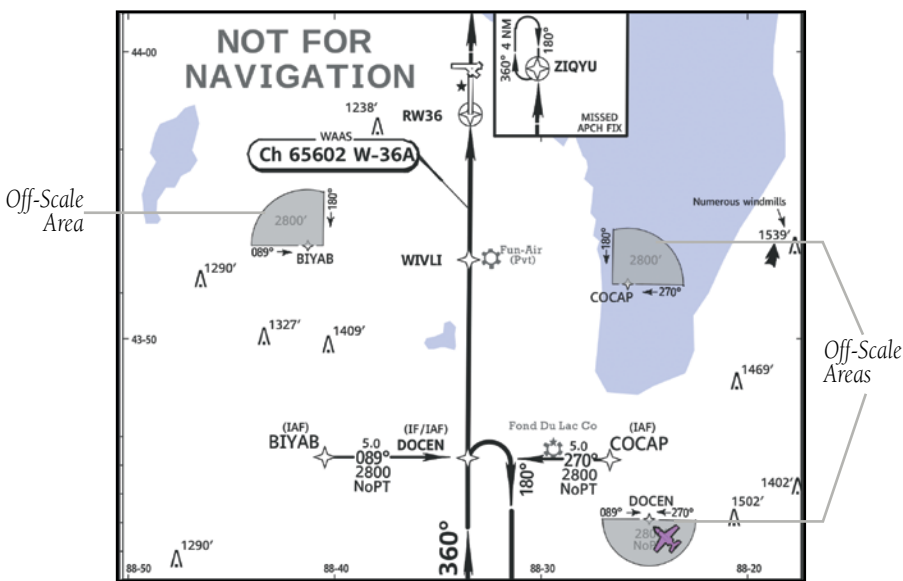

Sample Chart Indicating Off-Scale Areas

## Displaying ChartView:

- 1) From the Waypoint Page, touch the **TERPs** Tab.
- 2) If necessary, touch the Waypoint Identifier Field at the top of the page.
- 3) Enter the desired airport using the keypad or the **Find** option.
- 4) Touch  to display a list of charts.
- 5) Touch the desired chart from the list.

When a terminal procedure chart is not available for the requested airport or there is an error rendering the data, the banner “CHART NOT AVAILABLE” appears on the screen. The “CHART NOT AVAILABLE” banner does not refer to the ChartView subscription, but rather the availability of a particular airport chart selection or procedure for a selected airport.



Chart Not Available Banner

## AIRCRAFT SYMBOL

The aircraft symbol is shown in magenta on the chart only if the chart is to scale and the aircraft position is within the boundaries of the chart. The aircraft symbol is not displayed when the Aircraft Symbol Not Shown Icon (X over the aircraft symbol) appears in the lower right corner. The Aircraft Symbol Not Shown Icon may appear at certain times, even if the chart is displayed to scale.

## CHART RANGE

### Changing the chart range:

From the Waypoint Page with the TERPs Tab selected, touch - or + to change the range.

## NAVIGATION DATABASE-PUBLISHED NOTAMS



**NOTE:** Only NOTAMs for the selected airport is shown (when available). There may be other NOTAMs available pertaining to the flight that may not be displayed. Contact Jeppesen for more information regarding Jeppesen database-published NOTAMs.

Recent NOTAMs applicable to the current ChartView cycle are included in the ChartView database. If NOTAMs are available for the selected airport, a 'Chart NOTAMs' option will be displayed at the bottom of the drop-down menu of available charts. Select the 'Chart NOTAMs' option from the chart menu to display the applicable NOTAM information.

## 8.4 FLITECHARTS®



**WARNING:** Do not use the approach information provided by the VFR navigation database residing within the G3X Touch as a means of navigating any instrument approach. The G3X Touch VFR navigation database is limited to present only the waypoints for the final approach leg of a published procedure. These waypoints and associated course line are made available for monitoring purposes only.

FliteCharts resemble the paper version of National Aeronautical Charting Office (NACO) terminal procedures charts. The charts are displayed with high-resolution and in color for applicable charts. FliteCharts database subscription is available from Garmin. Available data includes:

- Arrivals (STAR)
- Departure Procedures (DP)
- Approaches
- Airport Diagrams
- Takeoff Minimums
- Alternate Minimums

The geo-referenced aircraft position is indicated by an aircraft symbol displayed on the chart when the current position is within the boundaries of the chart. An aircraft symbol may be displayed within an off-scale area depicted on some charts.

The figure below shows examples of off-scale areas, indicated by the grey shading. Note, these areas are not shaded on the published chart. These off-scale areas appear on the chart to convey supplemental information. However, the depicted geographical position of this information, as it relates to the chart planview, is not the actual geographic position. Therefore, when the aircraft symbol appears within one of these areas, the aircraft position indicated is relative to the chart planview, not to the off-scale area.

- System Overview
- Flight Instruments
- EIS
- CNS Interface
- GPS Navigation
- Flight Planning
- Hazard Avoidance
- Additional Features
- AFCs
- Annun/Alerts
- Appendix
- Index

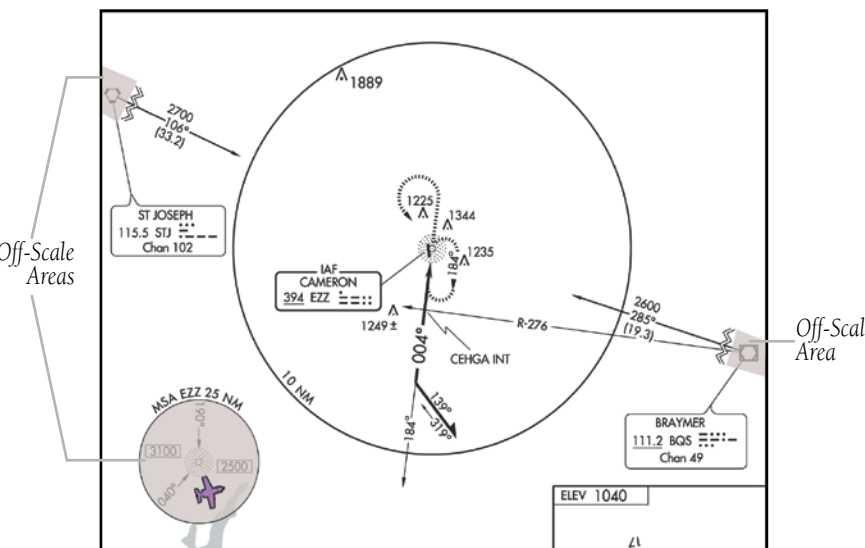
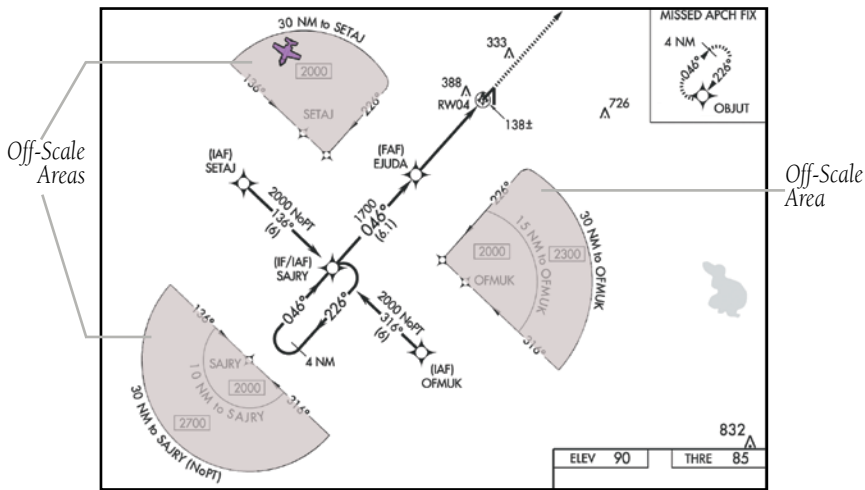

Sample Chart Indicating Off-Scale Areas



**NOTE:** Do not maneuver the aircraft based solely upon the geo-referenced aircraft symbol.

### Displaying FliteCharts:

- 1) From the Waypoint Page, touch the **TERPs** Tab.
- 2) If necessary, touch the Waypoint Identifier Field at the top of the page.
- 3) Enter the desired airport using the keypad or the **Find** option.
- 4) Touch  to display a list of charts.
- 5) Touch the desired chart from the list.

Airport Identifier

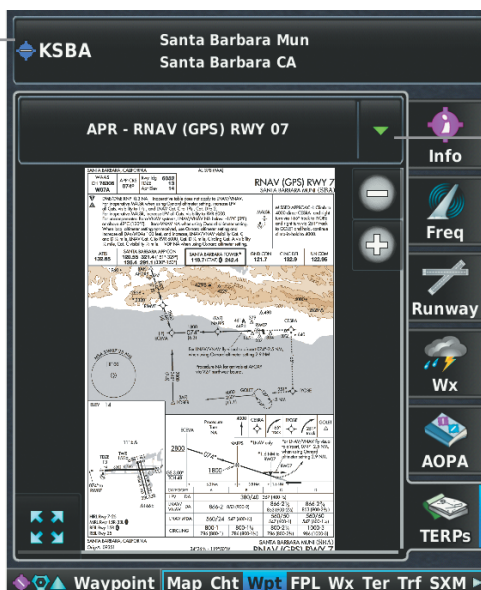

Touch to view Available Approaches

### FliteCharts

When a terminal procedure chart is not available for the requested airport or there is an error rendering the data, the banner "CHART NOT AVAILABLE" appears on the screen. The "CHART NOT AVAILABLE" banner does not refer to the FliteCharts subscription, but rather the availability of a particular airport or procedure for a selected airport.



Chart Not Available Banner

## AIRCRAFT SYMBOL

---

The aircraft symbol is shown in magenta on the chart only if the chart is to scale and the aircraft position is within the boundaries of the chart. The aircraft symbol is not displayed when the Aircraft Not Shown Icon appears. The Aircraft Not Shown Icon may appear at certain times, even if the chart is displayed to scale.

## CHART RANGE

---

### Changing the chart range:

From the Waypoint Page with the TERPs Tab selected, touch - or + to change the range.

## FLITECHARTS CYCLE NUMBER AND EXPIRATION DATE

---

FliteCharts data is revised every 28 days. FliteCharts do not expire and will remain viewable after the expiration date. The Power-up Page indicates any of four different possible criteria for chart availability. These indications are whether the databases are not configured, not available, current or out of date.



## 8.5 AIRPORT DIRECTORY DATA

The Airport Directory contains airport statistics such as pattern altitudes, noise abatement information, FBO phone numbers, hours of operation, local attractions, ground transportation, lodging, and services.

The AOPA Airport Directory provides data on airports and heliports throughout the U.S. and it is updated on a 56-day cycle. Detailed information for over 5,300 U.S. airports, along with the names and phone numbers of thousands of FBOs can be viewed. This service allows the pilot to plan an overnight, choose fuel stops, find ground transportation, etc.

Optional airport directory databases such as AC-U-KWIK are also supported. AC-U-KWIK provides complete listings of FBOs, charter companies, fuel suppliers, ground transportation, maintenance and catering services at public airports across the world.

If the AOPA database is in use, the **AOPA** Tab is displayed on the Waypoint (WPT) Page. If another airport directory database is in use, such as AC-U-KWIK, the **DIRECTORY** Tab is displayed on the Waypoint (WPT) Page.

### Viewing Airport Directory information:

From the Waypoint (WPT) Page, touch the **AOPA** or **DIRECTORY** Tab.

- System Overview
- Flight Instruments
- EIS
- CNS Interface
- GPS Navigation
- Flight Planning
- Hazard Avoidance
- Additional Features
- AFCs
- Annun/Alerts
- Appendix
- Index

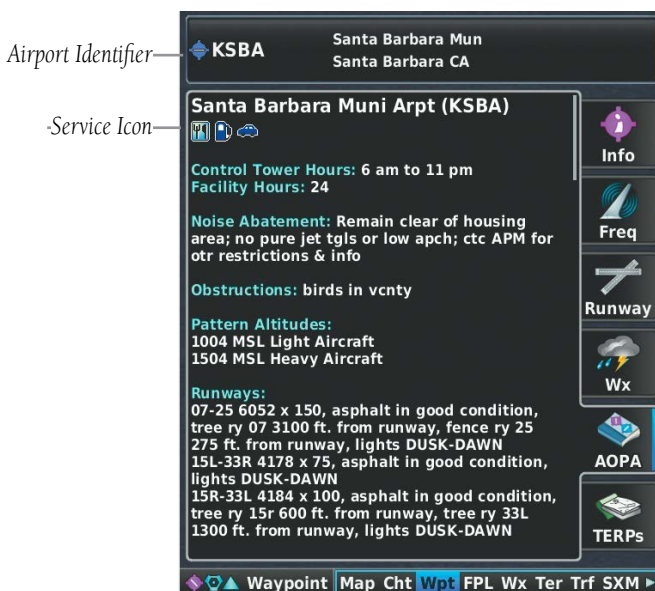

## Airport Directory Information

Icon	Description
	Restaurant on Field
	Self Serve Fuel
	Courtesy Car

## Airport Directory Service Icons

## 8.6 SIRIUSXM RADIO ENTERTAINMENT (OPTIONAL)



**NOTE:** See the G3X Touch Installation Manual for SiriusXM activation instructions.



**NOTE:** SiriusXM Radio is only available with the optional GDU 465 or GDU 455.



**NOTE:** Refer to the Hazard Avoidance Section for information about Weather products.

SiriusXM Satellite Radio offers a variety of radio programming over long distances without having to constantly search for new stations. Based on signals from satellites, coverage far exceeds land-based transmissions. SiriusXM Satellite Radio services are subscription-based.

### ACTIVATING SIRIUSXM SATELLITE RADIO SERVICES

The service is activated by providing SiriusXM Satellite Radio with a coded ID (Radio ID).

#### Accessing the Radio ID:

- 1) From the **SXM** Page, press the **MENU** Key.
- 2) Touch **More Info....**

### USING SIRIUSXM RADIO

The SXM Page provides information and control of the audio entertainment features of the SiriusXM Satellite Radio.

#### Selecting the SXM Page:

- 1) Touch the Page Navigation Bar.
- 2) Touch **SiriusXM**.

- System Overview
- Flight Instruments
- EIS
- CNS Interface
- GPS Navigation
- Flight Planning
- Hazard Avoidance
- Additional Features
- AFCS
- Annun/Alerts
- Appendix
- Index

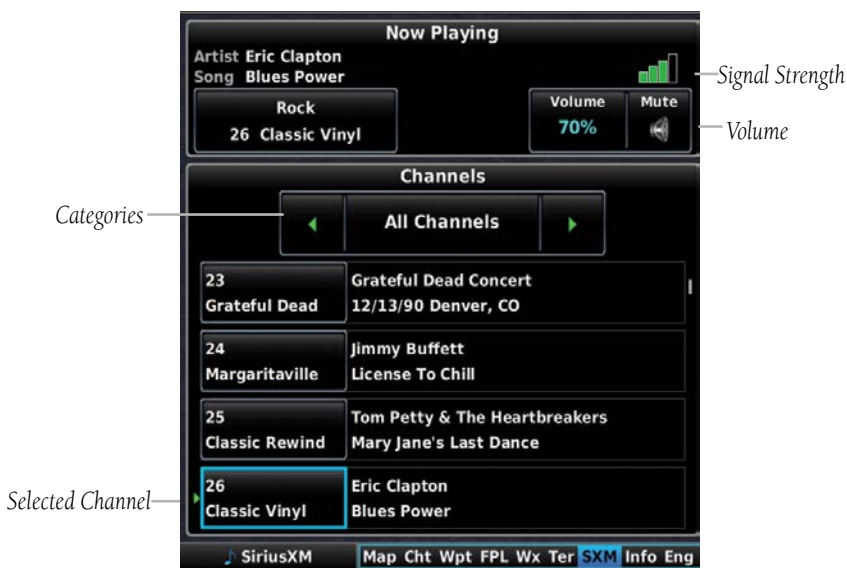

SXM Page

### Selecting a category:

From the SXM Page, touch to cycle through the categories.

### Selecting a channel:

From the SXM Page, touch a Channel to select it.

### Adding a channel to Favorites:

- 1) From the SXM Page, touch a Channel to select it.
- 2) Press the **MENU** Key.
- 3) Touch **Add to Favorites**.

### Selecting Favorites:

From the SXM Page, touch to cycle through the categories until you see the Favorites Category.

### Deleting a channel from Favorites:

- 1) With a Favorite Channel selected, press the **MENU** Key.
- 3) Touch **Remove Favorite**.

## VOLUME

### Adjusting the volume:

From the SXM Page, touch the volume, and touch the volume slider to adjust the volume.

## 8.7 VERTICAL POWER (OPTIONAL)

The Vertical Power electronic circuit breaker (VP-X) integrates with the G3X Touch system to provide a visual display of the aircraft's electrical system. From the Vertical Power (VP-X) Page pilots control, view and respond to electrical faults. The Vertical Power (VP-X) Page only appears when a VP-X is connected, configured and operational.

When an electrical device is selected, device sensitive menu options appear, which provide the pilot with control of the device from the GDU. Devices connected to the VP-X can be controlled via dedicated switches. The Vertical Power system can be connected to the PFD or MFD.

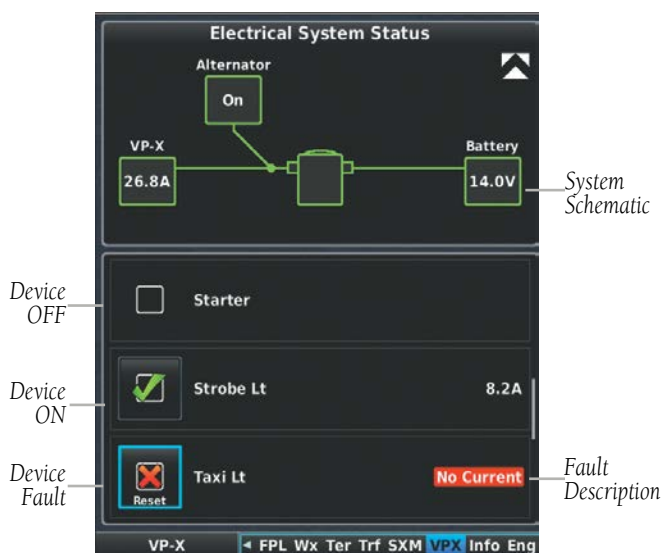

Vertical Power (VP-X) Page

Device Controls	Description
ON/OFF	Device sensitive controls for devices such as; Fuel Pump, Landing light, or anything else that would have an on/off type function.
TRIM UP/TRIM DN	Device sensitive controls for Pitch Trim devices.
TRIM L/TRIM R	Device sensitive controls for Roll Trim devices.
FLAPS UP/FLAP DN	Device sensitive controls for a Flap motor.
AUTO	Only appears when the landing light(s) have been configured to 'wig-wag'. When AUTO (default) is selected the VP-X will automatically pulse (wig-wag) the landing lights based on the current phase of flight. When AUTO is not selected the landing lights will remain steady-on (no wig-wag).
RESET	Only appears when the selected device is in a fault condition. By selecting 'RESET' the VP-X will attempt to clear the fault (similar to resetting the circuit breaker).

## Device Sensitive Controls

### Selecting and controlling an electrical device from the list:

- 1) With the **VP-X** Page displayed, touch the desired device.
- 2) Press the **MENU** Key.
- 3) Touch the desired function from the list.

**Or:**

Select touch **Reset**, to reset a faulted device.

## 8.8 ELECTRONIC CHECKLISTS (OPTIONAL)



**NOTE:** The information described in this section is not intended to replace the checklist information described in the AFM.



**NOTE:** Garmin does not create, modify, or update G3X Touch checklists and thus cannot be responsible for the availability and/or content.



**NOTE:** Checklists cannot be edited from within the system.

The G3X Touch is capable of displaying checklists (if available from the aircraft manufacturer) which allow a pilot to quickly find the proper procedure on the ground and during each phase of flight. The G3X Touch accesses the checklist file (\*.ace) from the root directory (/\*.ace) of the SD card. If a checklist file is available on the SD card, the 'Checklists' Main Menu Option will appear. The Checklist Editor may be downloaded from the Updates & Downloads page which can be accessed via the G3X or G3X Touch webpage or by entering the following URL into a web browser: <http://www8.garmin.com/support/collection.jsp?product=010-00G3X-00&cID=155&pID=63892>.

## 8.9 FLIGHT DATA LOGGING

The flight data logging feature automatically stores flight and engine data to an SD card. Data is recorded to the SD card every second. A data file is created each time the system is powered on with an SD card inserted, or each time an SD card is inserted after power on. A 2 GB SD card can store over 1,000 hours of flight data or up to 1,000 files (whichever comes first). The data files stored on the SD card have an extension of .csv. This file format can be opened using a spread sheet application on a personal computer. Garmin recommends using a 8 GB SanDisk or Toshiba SD card.

## 8.10 VIRB VIDEO INPUT



**NOTE:** Configuring this feature allows the camera to be controlled wirelessly. Viewing the video on the display requires a wired connection to the video input on the back of the display.

### Displaying/removing the Video In Page on the Page Navigation Bar:

- 1) Press the **MENU** Key twice.
- 2) Touch **Setup** > **Display**.
- 3) In the **Video Main Page** field, touch **Show** or **Hide**.

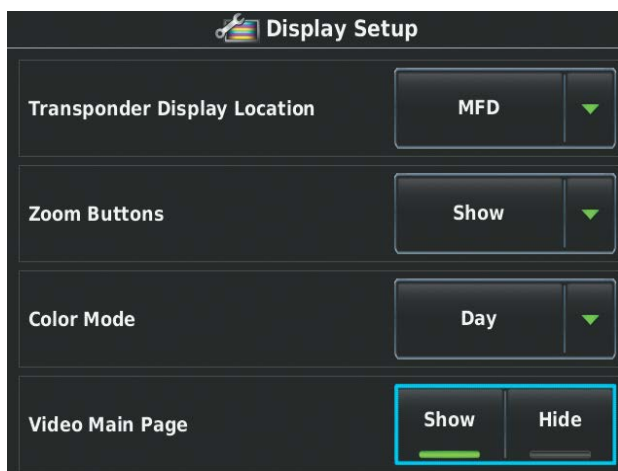

Show/Hide Video Main Page

Display Setup



### Displaying the Video In Page:

- 1) Touch the page navigation bar.
- 2) Touch **Video In**
- 3) Touch **Video Input**.

**Or:**

Touch the Video Input PFD inset Window.



*Video In Page*

### Video In Page

### Displaying the VIRB Video Input in the PFD inset window:

- 1) From the full screen PFD, touch the **MENU** Key.
- 2) Touch the left or right **Inset Window** Button.
- 3) Touch **Video Input**.

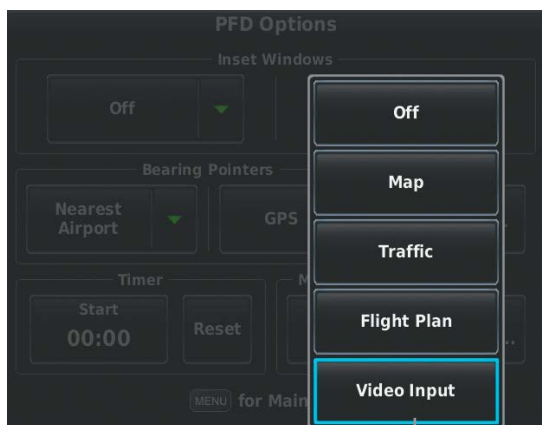

*Displays Video Input in the PFD Inset Window*

### PFD Options

- System Overview
- Flight Instruments
- EIS
- CNS Interface
- GPS Navigation
- Flight Planning
- Hazard Avoidance
- Additional Features
- AFCs
- Annun/Alerts
- Appendix
- Index



Video Input in the PFD Inset Window

## PFD Inset Windows

### Displaying the VIRB Video Input in the PFD inset window:

- 1) From the full screen PFD, touch the **MENU** Key.
- 2) Touch the right **Inset Window** Button.
- 3) Touch **Video Input**.

### Pairing the VIRB to the G3X Touch:

Pairing the VIRB to the G3 X Touch is a 2-part procedure which involves first selecting settings on the VIRB, then selecting settings on the GDU.



**NOTE:** Stay 10 m away from other ANT+ sensors while pairing.

- 1) Setting up the VIRB for pairing.
  - a) On a VIRB/VIRB Elite, select **MODE > SETUP**. On a VIRB X/VIRB XE, use the Menu button to access **SETUP** mode.
  - b) Use the arrow keys to highlight **REMOTE**, then press **OK**.
  - c) Use the arrow keys to turn **REMOTE ON/OFF** field to **ON**.
  - d) Use the arrow keys to highlight **VIRB TYPE** and select **MAIN VIRB**.
  - e) Bring the VIRB within range (3m) of the G3X Touch.

- 2) Setting up the GDU for pairing.
  - a) Press the **MENU** Key twice.
  - b) Touch **Tools > VIRB**.
  - c) For initial pairing with a new camera, touch **Search For VIRB**.
  - d) When connecting to a VIRB that has previously been paired, touch **CONNECT**. The VIRB should quickly be found and added to the GDU pairing list.
  - e) After the VIRB is paired with the G3X Touch, the VIRB status displays **Connected** in green.

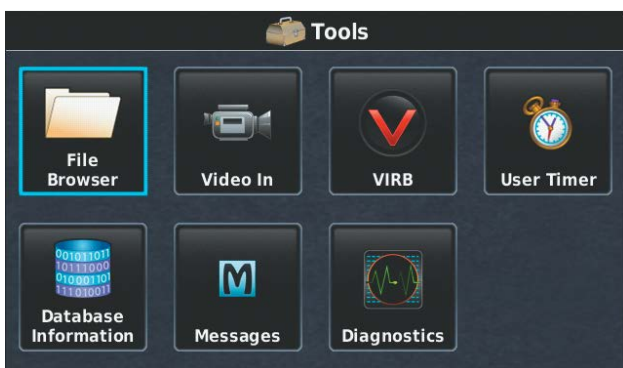

Tools Menu

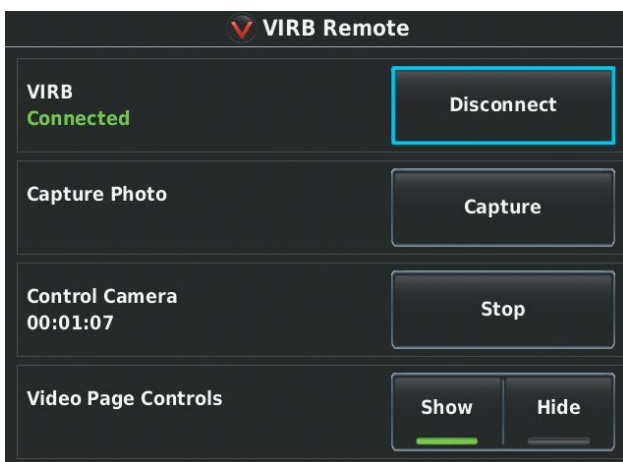

VIRB Remote

### Searching for new VIRB video input:

- 1) Press the **MENU** Key twice.
- 2) Touch **Tools > VIRB**.
- 3) Press the **MENU** Key and touch **Search For New VIRB**.

### Displaying/removing video page controls:

- 1) Press the **MENU** Key twice.
- 2) Touch **Tools > VIRB**.
- 3) In the **Video Page Controls** field, touch **Show** or **Hide**.

#### Or:

- 1) Press the **MENU** Key twice.
- 2) Touch **Tools > Video In**.
- 3) Press the **MENU** Key.
- 4) Touch **Show/Hide VIRB Controls**.

### Capturing a photo using the VIRB video input:

- 1) With the video recording, press the **MENU** Key twice.
- 2) Touch **Tools > VIRB > Capture**.

#### Or:

Touch **Tools > Video In > Capture**.

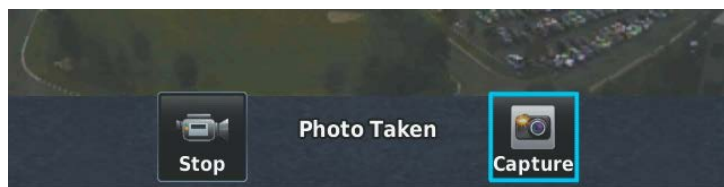

Video In

### Recording video using the VIRB video input:

- 1) With the VIRB connected, press the **MENU** Key twice.
- 2) Touch **Tools > VIRB > Record**.

#### Or:

Touch **Tools > Video In > Record**.

### Stop recording video using the VIRB video input:

- 1) With the VIRB connected and recording video, press the **MENU** Key twice.
- 2) Touch **Tools > VIRB > Stop**.

**Or:**

Touch **Tools > Video In > Stop**.

### Scale VIRB video input:

- 1) With the video recording, press the **MENU** Key twice.
- 2) Touch **Tools > Video In**.
- 3) Press the **MENU** Key.
- 4) Touch **Scale to fit width**, **Scale to fit height**, **Scale to best fit (maintain aspect)**, or **Scale to screen (stretch)**.

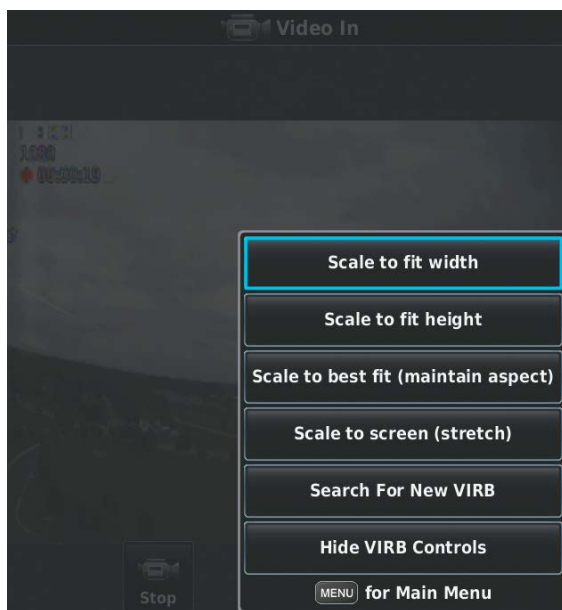

Video In Page Menu

# 8.11 CONNEXT COCKPIT CONNECTIVITY

System Overview

Flight Instruments

EIS

CNS Interface

GPS Navigation

Flight Planning

Hazard Avoidance

Additional Features

AFCs

Annun/Alerts

Appendix

Index



**NOTE:** Interfacing with iOS devices requires a Connex config module for proper Bluetooth operation. Without this config module the G3X Touch/ Garmin Pilot authentication will not complete. Refer to the G3X Touch Installation Manual for more information.



**NOTE:** In a multiple display G3X Touch system, Connex Bluetooth connections to Garmin Pilot devices should only be made to the PFD1 display.

Connex allows the wireless sharing of data between devices via Bluetooth®. For example:

- Flight plans are wirelessly transferred from a mobile device (using Garmin Pilot™) to the G3X Touch or external navigator (if configured).
- An iOS or Android device (with Garmin Pilot™) paired with both a G3X Touch and GDL 39/39R, shares GPS, attitude, traffic and weather data.

The following platforms support Connex:

iOS 8.1 +	Android 4.4 +
iPhone 5 and Newer	Google Nexus Devices
iPad 3 and Newer	Samsung Galaxy Note 10.1
iPad Air and Newer	Samsung Galaxy S5
iPad Mini with Retina and Newer	Samsung Galaxy S4

### Connex Supported Platforms

#### Connex Bluetooth pairing recommendations:

- 1) Only use the Bluetooth interface on PFD1 for Connex data sharing with iOS or Android devices using Garmin Pilot.
- 2) Do not attempt to pair the displays to each other in a multiple display installation.
- 3) Turn off the Bluetooth transceiver for any display which is not using it.



**NOTE:** In general one or two iOS or Android devices running Garmin Pilot may be connected as shown below. Due to the wide variability of these devices, the best user experience may, in some cases, be limited to a single mobile device connected to the system components.

Connex Bluetooth Supported Configurations	
<p>One or two Android or iOS devices may be connected to the G3X Touch</p>	
<p>One Android or iOS* device may be connected to both a GDL 39/39R and a G3X Touch.</p> <p>A second Android or iOS* device may be connected to either the GDL 39/39R or the G3X Touch, but not both.</p>	

\*iOS Garmin Pilot 7.2+ with location data disabled

- System Overview
- Flight Instruments
- EIS
- CNS Interface
- GPS Navigation
- Flight Planning
- Hazard Avoidance
- Additional Features
- AFCs
- Annun/Alerts
- Appendix
- Index

## Pairing the G3X Touch with an iOS or Android device:



**NOTE:** For iOS and Android devices, the Bluetooth pairing to the G3X Touch may be established from the iOS or Android Bluetooth settings page with the G3X touch Bluetooth Setup Page selected and visible.

- 1) Power on the iOS or Android device and ensure Bluetooth® is turned on in Settings.
- 2) Refer to the iOS or Android device's documentation for instructions on making the device discoverable.
- 3) Refer to the iOS or Android device's documentation for instructions on finding the device name. Take note of the device name as it is the name you will want to select in step 8.
- 4) Press the **MENU** Key twice.
- 5) Touch **Setup > Bluetooth**.
- 6) If Bluetooth is set to **Off**, touch the **Bluetooth** .
- 7) Touch **On**. The G3X Touch will begin searching for devices.
- 8) When the G3X Touch has completed the search for available devices, touch **Not Paired** next to the iOS or Android device to be paired.

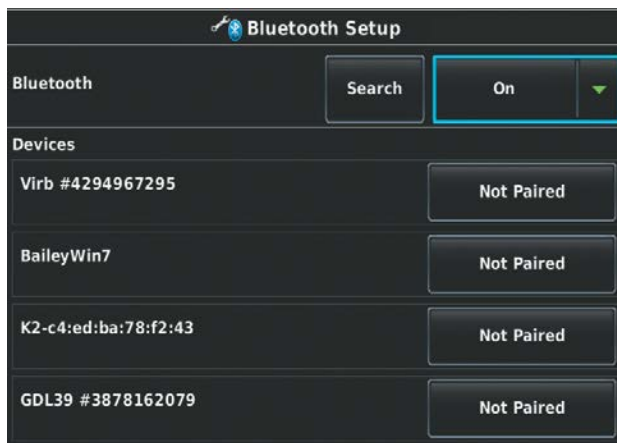

Bluetooth Setup



- 9) The first time a device is paired, a Bluetooth Passkey Window may be displayed to confirm what device you are attempting to pair with. Touch **OK** to confirm the passkey. When the device is paired, **Connected** is displayed next to the device.

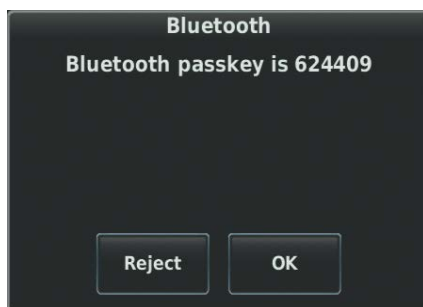

Bluetooth Passkey Window



**NOTE:** Once an iOS device is initially paired to the G3X Touch, the Bluetooth connection is automatic each time both devices are powered up.



**NOTE:** Once an Android device is initially paired to the G3X Touch, the Bluetooth connection is automatic each time Garmin Pilot is started.

### Transferring a flight plan from an iOS or Android device to the G3X Touch:

- 1) If not already paired, pair the iOS or Android device to the G3X Touch. Refer to the previous procedure. NOTE: Previously paired devices are saved to make future connections automatic.
- 2) Install (if not already installed) and open the Garmin Pilot App on the iOS/Android device.
- 3) If an external navigator is configured, touch **FPL Source > Internal** or **FPL Source > External** on the Flight Plan Page of the G3X Touch.
- 4) Send a flight plan to the G3X Touch from the Garmin Pilot App on the device. Refer to the Garmin Pilot Help File for more information on sending a flight plan to a navigator.
- 5) Tell the G3X Touch or external navigator what to do with the transferred flight plan:  
If **FPL Source > Internal** is selected on the Flight Plan Page, a **Flight**

**Plan Received** notification is displayed on the G3X Touch. Touch one of the following:

**Ignore:** Discard the flight plan.

**Store:** Save the flight plan to the Flight Plan List.

**Activate:** Activate the flight plan without saving it to the Flight Plan List.



Flight Plan Received Notification

**Or:**

If **FPL Source > External** is selected on the Flight Plan Page, the flight plan is automatically pushed to the external navigator. A message flashes on the external navigator to prompt the pilot to review and accept the flight plan. The pilot can then choose to save or activate the transferred flight plan on the external navigator.

## Pairing the G3X Touch to a GDL39/39R:



**NOTE:** Bluetooth pairing is not necessary, and should not be performed, on a display where the GDL39/39R is hardwired to the display.

- 1) Power on the GDL39/39R. The GDL39/39R will automatically enter Bluetooth pairing mode.
- 2) Press the **MENU** Key twice.
- 3) Touch **Setup > Bluetooth**.
- 4) If Bluetooth is set to **Off**, touch the **Bluetooth** .
- 5) Touch **On**. The G3X Touch will begin searching for devices.
- 6) When the G3X Touch has completed the search for available devices, touch **Not Paired** next to the GDL39/39R.

- The first time a device is paired, a Bluetooth Passkey Screen will be displayed to confirm what device you are attempting to pair with. Touch **OK** to confirm the passkey. When the device is paired, **Connected** is displayed next to the device.

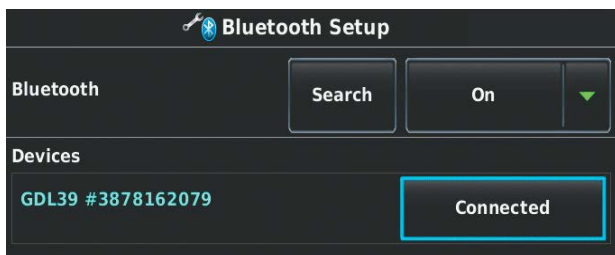

Bluetooth Setup

- Press the **BACK** Key twice and touch **Data Link** to display the device information.

Data Link Information	
Device	GDL39 3.10 3878162079
Status	Connected
GPS Position	Valid (External)
Pressure Altitude	1390ft
Ground Uplink Signal	<input type="checkbox"/> <input type="checkbox"/> <input type="checkbox"/> <input type="checkbox"/>
TIS-B Traffic Data	Disabled
Air-To-Air Traffic	Disabled
AIRMETs	--:--
METARs	-00:02
NEXRAD Radar (CONUS)	--:--
NEXRAD Radar (Regional)	--:--
NOTAMs	-00:02
PIREPs	-00:02
SIGMETs	--:--
TAFs	-00:02
Temperatures Aloft	--:--
TFRs	-00:02
Winds Aloft	--:--

Data Link Information

## 8.12 ELECTRONIC STABILITY & PROTECTION (ESP-X)



**WARNING:** Do not assume ESP-X will provide stability protection in all circumstances. There are in-flight situations that can exceed the capabilities of ESP-X technology.



**NOTE:** Third party autopilot installations are not supported for ESP-X. ESP-X requires Garmin GSA 28 servos.

Electronic Stability and Protection (ESP) is an optional feature that is intended to monitor the aircraft and provide control input feedback when necessary to discourage operating the aircraft at potentially unsafe attitudes and/or airspeeds. If enabled, this feature will automatically arm when the aircraft is above 500 feet AGL and the autopilot is not engaged, and disarm when below 200 feet AGL.

When selected, ESP engages automatically when the aircraft approaches or exceeds one or more predetermined airspeed or attitude limitations. Stability protection for each flight axis is provided by the autopilot servos, which apply force to the appropriate control surface(s) to discourage pilot control inputs that would cause the aircraft to exceed the normal or "protected" flight envelope. This is perceived by the pilot as resistance to control movement in the undesired direction when the aircraft approaches a steep attitude, and/or the airspeed is below the minimum or above the maximum configured airspeed.

As the aircraft deviates further from the normal attitude and/or airspeed, the force increases proportionally (up to an established maximum) to encourage control movement in the direction necessary to return to the normal attitude and/or airspeed range.

When ESP has been engaged for more than fifteen seconds (cumulative; not necessarily consecutive seconds) of a 30-second interval, the autopilot can be configured to engage with the flight director in Level Mode, bringing the aircraft into level flight. An aural "Autopilot" alert is played and the flight director mode annunciation will indicate 'LVL' for vertical and lateral modes.

Level mode as activated by ESP is limited by altitude. ESP will not be able to activate Level mode until the aircraft climbs above 2000 feet AGL. ESP will be locked out of automatically activating Level mode after the aircraft descends below 1500 feet AGL as well. Also note that Level mode as activated by ESP is different than manually selected Level mode. Manually selected Level mode is not limited by altitude at all.

The pilot can interrupt ESP by pressing and holding the Autopilot Disconnect / Control Wheel Steering (AP DISC / CWS) switch. Upon releasing the AP DISC / CWS switch, ESP force will again be applied. ESP can also be overridden by overpowering the servo's torque limit.

ESP is configured on the Electronic Stability Configuration page in Configuration Mode. Refer to the Installation Manual for more information on configuring ESP.

ESP is enabled or disabled from the Automatic Flight Control System page or using an externally wired ESP discrete switch.

### Enabling/Disabling ESP using the G3X Touch Autopilot Interface:

- 1) From the PFD, touch the Autopilot Status Box. The Automatic Flight Control System page is displayed.
- 2) Touch the **ESP** button on the Automatic Flight Control System page to enable/disable ESP.

ESP can be configured to be automatically enabled on system power-up.

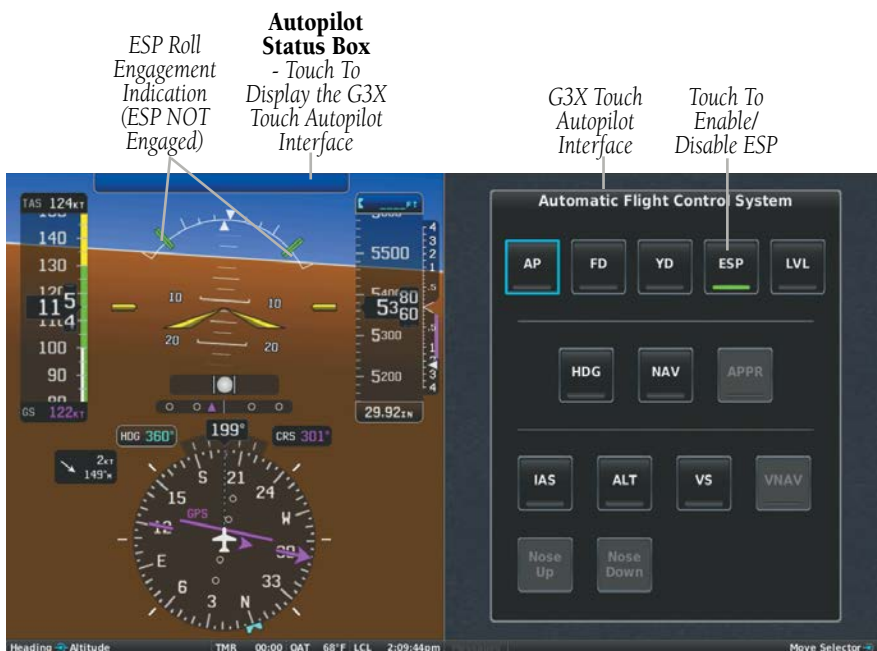

AFCS (ESP Enabled)

## ROLL ENGAGEMENT

Roll Limit Indicators displayed on the roll scale are configurable between 45° and 60° right and left, indicating where ESP will engage. As roll attitude exceeds the configured limit, ESP will engage and the Roll Limit Indicators will move to 15° less than the configured ESP bank limit. The Roll Limit Indicator now indicates where ESP will disengage as roll attitude decreases.

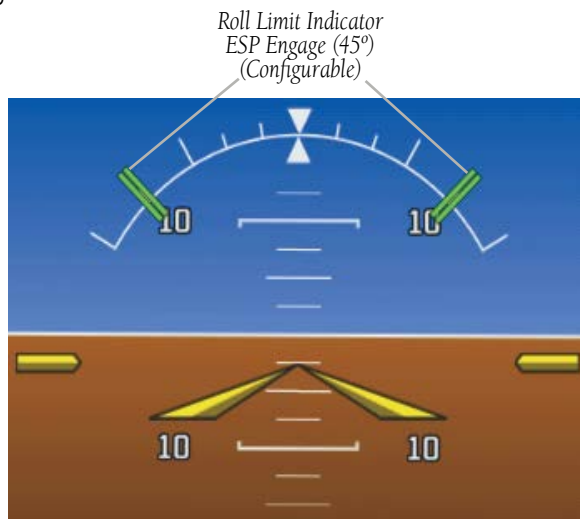

### ESP Roll Engagement Indication (ESP Enabled but NOT Engaged)

ESP Engage (45°) (Configurable)  
Aircraft Roll Attitude = 35°

ESP Disengage (30°)  
(15° < Configured Bank Limit)

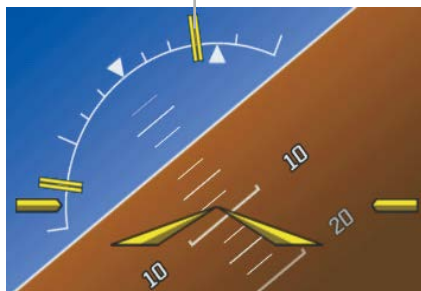
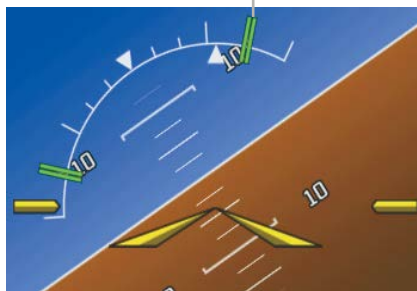

Roll Increasing to ESP Engagement

Once engaged, the torque applied by ESP is at its maximum when bank angle is 15° more than the configured bank limit, and tapers to the minimum applied torque when the bank angle is 15° less than the configured bank limit. The force increases as roll attitude increases and decreases as roll attitude decreases. The applied force is intended to encourage pilot input to return the airplane to a more normal roll attitude. When beyond 15° of the configured bank limit, the maximum torque is held until the aircraft returns inside the protected envelope.

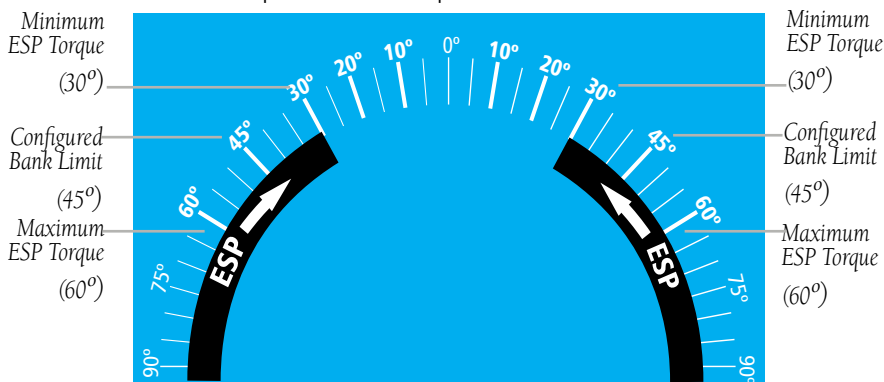

**ESP Roll Operating Range When Engaged**  
 (Force Increases as Roll Increases & Decreases as Roll Decreases)

## PITCH ENGAGEMENT

ESP pitch engagement is configurable between 10° and 25° nose-up and between 5° and 25° nose-down. Once engaged, the torque applied by ESP is at its maximum when pitch is 5° more than the configured nose-up and nose-down pitch limits, and tapers to the minimum applied torque when pitch is 5° less than the configured nose-up and nose-down pitch limits. When beyond 5° of the configured pitch limit, the maximum torque is held until the aircraft returns inside the protected envelope.

The opposing force increases or decreases depending on the pitch angle and the direction of pitch travel. This force is intended to encourage movement in the pitch axis in the direction of the normal pitch attitude range for the aircraft.

The presence of yellow chevrons indicate that ESP is engaged in these nose-up/nose-down conditions.

- System Overview
- Flight Instruments
- EIS
- CNS Interface
- GPS Navigation
- Flight Planning
- Hazard Avoidance
- Additional Features
- AFCs
- Annun/Alerts
- Appendix
- Index

- System Overview
- Flight Instruments
- EIS
- CNS Interface
- GPS Navigation
- Flight Planning
- Hazard Avoidance
- Additional Features
- AFCs
- Annun/Alerts
- Appendix
- Index



ESP Engaged (Nose-Low)



ESP Engaged (Nose-High)

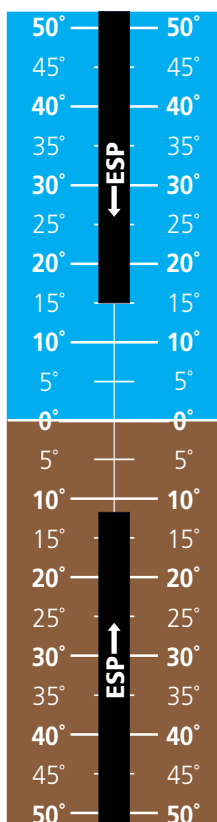

**ESP Pitch Operating Range When Engaged**  
 (Force Increases as Pitch Increases & Decreases as Pitch Decreases)



## AIRSPEED PROTECTION

An airspeed below the minimum configured airspeed or above maximum configured airspeed will result in ESP applying force to raise or lower the nose of the aircraft. When the high or low airspeed condition is remedied, ESP force is no longer applied.



ESP Engaged (Low Airspeed)

## 8.13 CARBON MONOXIDE (CO) DETECTOR (OPTIONAL)



**NOTE:** Refer to the approved Pilot's Operating Handbook (POH) for emergency procedures.

If a carbon monoxide (CO) detector is installed, the current CO measurement in parts per million (ppm) can be displayed in the data bar.

### Displaying the current CO measurement in the data bar field:

- 1) Press the **MENU** Key twice.
- 2) Touch **Setup > Data Bar > Change...**
- 3) Touch one of the data bar fields.
- 4) Touch **CO** from the list of data fields.

Carbon monoxide levels are recorded in the G3X Touch data log file as well.

CO Measurement In PPM

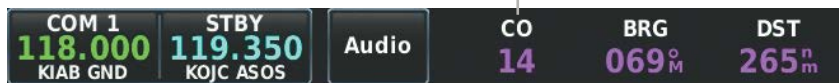

### Data Bar

In the event high CO levels are detected, the **CO** data field will flash yellow (if displayed) and a **CO LEVEL** CAS Message is displayed on the PFD.



CO Data Bar Field (High CO)



High CO CAS Message (PFD)

## 8.14 PULSE OXIMETER (OPTIONAL)



**NOTE:** Refer to the approved Pilot's Operating Handbook (POH) for emergency procedures.

If a pulse oximeter is installed, a CAS message reminder to check blood oxygen saturation (**CHECK SPO2**) will periodically appear on the PFD during flight at high altitudes.

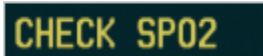

Pulse Oximeter CAS Message (PFD)

When blood oxygen saturation (SpO2) levels and pulse rate are being measured, the values are displayed in a CAS message displayed on the PFD.

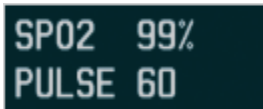

Pulse Oximeter CAS Message (PFD)

Blood Oxygen Saturation and Pulse Rate Measurements

## SECTION 9 AUTOMATIC FLIGHT CONTROL SYSTEMS (OPTIONAL)



**NOTE:** The approved Pilot's Operating Handbook (POH) always supersedes the information in this Pilot's Guide.



**NOTE:** Refer to the approved Pilot's Operating Handbook (POH) for emergency procedures.



**NOTE:** VOR, LOC, and GS modes are all GPS-aided. You must have a GPS position and a valid navigation database to use VOR, LOC, or GS modes.

### AFCS SYSTEM ARCHITECTURE

An Automatic Flight Control System (AFCS) is typically comprised of two major components: A Flight Director (FD) and Autopilot servos. The Flight Director provides pitch and roll commands to the autopilot servos. These pitch and rolls commands are displayed on the PFD as Command Bars. When the Flight Director is active the pitch and roll commands can be hand-flown by the pilot or when coupled with the autopilot, the autopilot servos drive the flight controls to follow the commands issued by the Flight Director. The Flight Director operates independently of the autopilot servos, but in most cases the autopilot servos can not operate independent of the Flight Director. On G3X Touch installations that do not have a separate and independent Flight Director, the Flight Director is always coupled to the autopilot.

### AUTOPILOT AND YAW DAMPER OPERATION

The autopilot and optional yaw damper operate the flight control surface servos to provide automatic flight control. The autopilot controls the aircraft pitch and roll attitudes following commands received from the flight director. Pitch, Roll, and Yaw (if installed) auto-trim provides trim commands to each servo to relieve any sustained effort required by the servo(s). Autopilot operation is independent of the optional yaw damper.

The optional yaw damper reduces Dutch roll tendencies, coordinates turns, and provides a steady force to maintain directional trim. It can operate independently of the autopilot and may be used during normal hand-flight maneuvers. Yaw rate commands are limited to 6 deg/sec by the yaw damper.

## FLIGHT CONTROL (GSA 28 AND GMC 305/307)

Pitch and roll commands are provided to the servos based on the active flight director modes. Yaw commands are provided by the yaw servo. Servo motor control limits the maximum servo speed and torque. Torque values are set at installation, see the G3X Touch installation manual for installation instructions. This allows the servos to be overridden in case of an emergency. Third party autopilot systems may not allow servos to be overridden, consult third party autopilot documents for limitations.

### PITCH AXIS AND TRIM

The autopilot pitch axis uses pitch rate to stabilize the aircraft pitch attitude during flight director maneuvers. Flight director pitch commands are rate and attitude-limited, combined with pitch damper control, and sent to the pitch servo motor. The pitch servo measures the output effort (torque) and optionally provides this signal to the pitch trim motor. The pitch servo commands the pitch trim motor to reduce the average pitch servo effort.



**NOTE:** Auto-trim may also be configured for the roll and/or yaw axis. Consult the G3X Touch installation manual for configuration and installation options.

### ROLL AXIS

The autopilot roll axis uses roll rate to stabilize aircraft roll attitude during flight director maneuvers. The flight director roll commands are rate- and attitude-limited, combined with roll damper control, and sent to the roll servo motor.

## YAW AXIS

The yaw damper uses yaw rate and roll attitude to dampen the aircraft's natural Dutch roll response. It also uses lateral acceleration to coordinate turns and reduce or eliminate the need for the pilot to use rudder pedal force to maintain coordinated flight during climbs and descents.

### **G3X TOUCH AFCS INSTALLATIONS OPTIONS**

The G3X Touch offers multiple Automatic Flight Control System installation options. The following options are discussed in this section:

- GDU 450/455/460/465 Primary Flight Display (PFD), plus a third party autopilot unit. Selecting an FD mode engages the autopilot.
- GDU 450/455/460/465 Primary Flight Display (PFD), plus GSA 28 servos. This option includes a separate FD. The FD can be on independent of the autopilot. Selecting a FD mode engages the autopilot.
- GDU 450/455/460/465 Primary Flight Display (PFD), plus third party autopilot, plus GMC 305/307 Mode Controller. This option includes a separate FD. The FD can be on independent of the autopilot. Selecting a FD mode does not engage the autopilot. This option does not support a Yaw Damper (YD).
- GDU 450/455/460/465 Primary Flight Display (PFD), plus GSA 28 servos, plus GMC 305/307 Mode Controller. This option includes a separate FD. The FD can be on independent of the autopilot. Selecting a FD mode does not engage the autopilot. This option supports a Yaw Damper (YD).

## CONTROL WHEEL STEERING (CWS) (OPTIONAL)



**NOTE:** *Not all third party autopilot units support Control Wheel Steering (CWS).*

Control Wheel Steering allows the aircraft to be hand-flown without disengaging the AFCS. Press and hold the autopilot unit's CWS Button (if equipped) to temporarily disengage the pitch and roll servos from the flight control surfaces and hand-fly the aircraft. The G3X Touch autopilot control is synchronized to the aircraft attitude during Control Wheel Steering. The green 'AP' annunciation is temporarily replaced by a white 'CW' for the duration of Control Wheel Steering maneuvers.

In most scenarios, releasing the CWS Button reengages the Autopilot with a new reference. Refer to (Vertical Modes) and (Lateral Modes) for Control Wheel Steering behavior in each mode.

## G3X TOUCH AFCS STATUS BOX

The AFCS status box displays Autopilot (AP), Optional Yaw Damper (YD), and Flight Director (FD) mode annunciations on the PFD. When a third party autopilot unit is engaged and the G3X Touch is issuing commands to it, lateral and vertical modes are displayed. When a third party autopilot unit is engaged but it is operating in a standalone mode (i.e., not responding to the G3X Touch commands), the Autopilot status (AP) is displayed; however, the lateral/vertical modes are not displayed.

Autopilot (AP) status is displayed on the far left of the G3X Touch Autopilot Status Box. Lateral modes are displayed in the center, and vertical modes are displayed on the right. Armed modes are displayed in white and active in green.

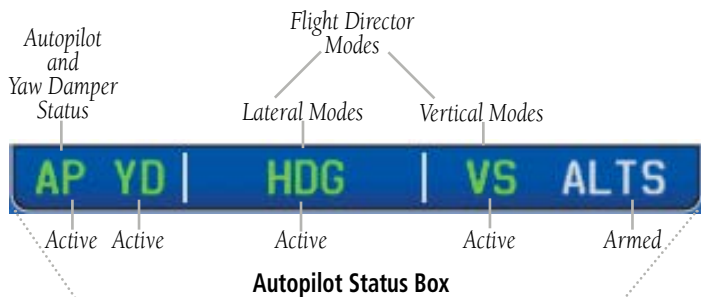

- System Overview
- Flight Instruments
- EIS
- CNS Interface
- GPS Navigation
- Flight Planning
- Hazard Avoidance
- Additional Features
- AFCS
- Annun/Alerts
- Appendix
- Index

## 9.1 AFCS OPERATION

When a GMC 305/307 is installed AFCS functionality is distributed across the following Line Replaceable Units (LRUs):

- GDU 450/455 Display Units
- GDU 460/465 Display Units
- GSU 73/25 ADAHRS Unit
- GMC 305/307 AFCS Mode Control Unit
- GSA 28 AFCS Pitch/Roll/Yaw Damper (optional) servos.

The AFCS system can be divided into these main operating functions:

- **Flight Director (FD)** — Flight director operation takes place within GDU 460/465. Flight director commands are displayed on the PFD. The flight director provides:

- Command Bars showing pitch/roll guidance
- Vertical/lateral mode selection and processing
- Autopilot communication

- **Autopilot (AP)** — Autopilot operation occurs within the pitch, roll, and yaw servos. It also provides servo monitoring and automatic flight control in response to flight director steering commands, Air Data and Attitude and Heading Reference System (ADAHRS) attitude, rate information, and airspeed.

- **Yaw Damper (YD)** — The yaw servo (optional), is self-monitoring and provides Dutch roll damping and turn coordination in response to yaw rate, roll angle, lateral acceleration, and airspeed. If installed the YD comes on when the autopilot is engaged and stays on after disengaging the autopilot. The YD can be turned on/off independent of the autopilot using the **YD Key**.

- **Manual Electric Trim (MET)** — Manual electric trim may provide trim capability for any properly configured axis (pitch, roll, or yaw) when the autopilot is not engaged.



The G3X Touch can also communicate with various third-party autopilot units. With an appropriate third-party autopilot installed and the G3X Touch Integrated Autopilot Interface is configured (refer to the G3X Touch Installation Manual), the G3X Touch issues pitch and roll steering commands to the autopilot unit. The autopilot unit is then responsible for moving the flight controls.

This section contains the following terminology:

- Autopilot Unit: Refers to the third-party autopilot box.
- Integrated Autopilot Interface: Refers to the functionality available when the Autopilot Unit and the G3X Touch are working together.



---

**NOTE:** Refer to the *G3X Touch Installation Manual* and the *third-party autopilot vendor documentation* for information on installing and configuring the *G3X Touch Integrated Autopilot Interface*.

---



---

**NOTE:** This section covers the operation of the *G3X Touch* when configured with specific *third-party autopilot models*. Refer to the *third-party autopilot vendor documentation* for standalone autopilot functionality and control features.

---



---

**NOTE:** In a multiple display configuration, the autopilot unit is connected to a single GDU (most likely the PFD). In the event that the GDU connected to the autopilot unit fails, the Integrated Autopilot Interface capability will be lost; however, the autopilot unit will retain any standalone functionality it may support on its own.

---

## AFCS PRE-FLIGHT ACTIONS

To ensure that the Automatic Flight Control System (AFCS) is operating properly prior to flight, perform the following Garmin recommended preflight checks.

### Before takeoff checklist - Garmin autopilot with GSA 28 servos, no mode controller:

- 1) Autopilot - ENGAGE (using **AP/CWS** button)
- 2) Flight controls - CHECK (verify autopilot can be overpowered in both pitch and roll)
- 3) **AP DISC** button - PRESS (verify autopilot disengages and audio alert is heard)
- 4) Flight controls - CHECK (verify autopilot servos are disengaged from pitch and roll controls, and all controls move freely)
- 5) Elevator trim control - SET FOR TAKEOFF

### Before takeoff checklist - Garmin autopilot with GSA 28 servos and GMC 305/307 mode controller:

- 1) Autopilot - ENGAGE (using AP/CWS button, or **AP** button on mode controller)
- 2) Flight controls - CHECK (verify autopilot can be overpowered in both pitch and roll)
- 3) **AP DISC** button - PRESS (verify autopilot disengages and audio alert is heard)
- 4) Yaw damper - OFF (if installed) (verify yaw damper disengages and audio alert is heard)
- 5) Flight director - SET FOR TAKEOFF (select TO or VS mode or push FD Button to turn off the Flight Director)
- 6) Flight controls - CHECK (verify autopilot servos are disengaged from pitch, roll, and yaw controls, and all controls move freely)
- 7) Elevator trim control - SET FOR TAKEOFF

## AFCS CONTROLS

### GMC 305/307 AFCS CONTROLS

The GMC 305/307 AFCS Control Units have the following controls:

- |   |                              |   |
|---|------------------------------|---|
| ① | <b>HDG Key</b>               | Selects/deselects Heading Select Mode   |
| ② | <b>NAV Key</b>               | Selects/deselects Navigation Mode. Cancels GS Mode if LOC Mode is either active or armed. Cancels GP Mode if GPS Mode is either active or armed. Cancels LOC Mode if GPS Mode is active and LOC Mode is armed.  |
| ③ | <b>AP Key</b>                | Engages/disengages the autopilot  |
| ④ | <b>LVL Key</b>               | Engages the autopilot (if the autopilot is disengaged) in level vertical and lateral modes  |
| ⑤ | <b>NOSE UP/DN Wheel</b>      | Adjusts the vertical mode reference in Pitch Hold, Vertical Speed, Indicated Airspeed, and Altitude Hold modes  |
| ⑥ | <b>IAS Key</b>               | Selects/deselects Indicated Airspeed Mode   |
| ⑦ | <b>ALT Key</b>               | Selects/deselects Altitude Hold Mode  |
| ⑧ | <b>VNV Key</b>               | Selects/deselects Vertical Path Tracking Mode for Vertical Navigation flight control  |
| ⑨ | <b>VS Key</b>                | Selects/deselects Vertical Speed Mode   |
| ⑩ | <b>YD Key</b> (if installed) | Engages/disengages the yaw damper   |
| ⑪ | <b>FD Key</b>                | Activates/deactivates the flight director only<br>Pressing once turns on the director in the default vertical and lateral modes. Pressing again deactivates the flight director and removes the Command Bars. If the autopilot is engaged, the key is disabled. |
| ⑫ | <b>APR Key</b>               | Selects/deselects Approach Mode   |
| ⑬ | <b>HDG Knob</b>              | Selects the desired Heading*  |
| ⑭ | <b>ALT SEL Knob</b>          | Selects the desired Altitude setting*   |

\*GMC 307 only

- System Overview
- Flight Instruments
- EIS
- CNS Interface
- GPS Navigation
- Flight Planning
- Hazard Avoidance
- Additional Features
- AFCS**
- Annun/Alerts
- Appendix
- Index

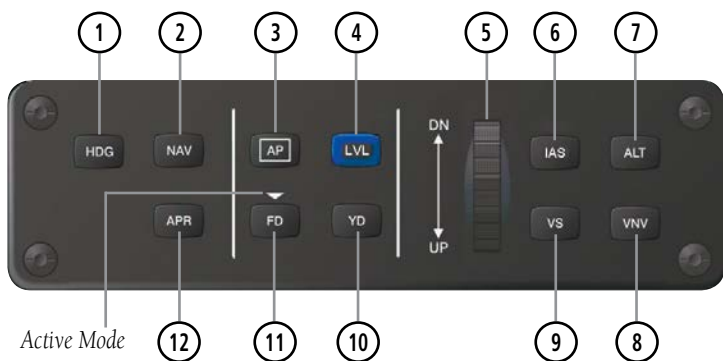

GMC 305 AFCS Control Unit

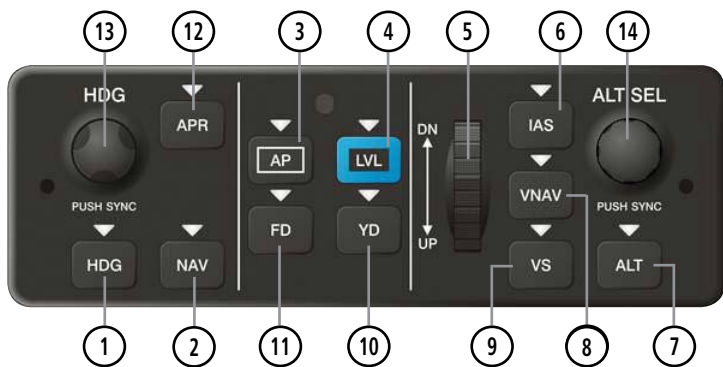

GMC 307 AFCS Control Unit

## G3X TOUCH AUTOPILOT INTERFACE

See figure on following page to view onscreen controls.

HDG	Selects/deselects heading mode
NAV	Selects/deselects navigation mode. Cancels GS Mode if LOC Mode is either active or armed. Cancels GP Mode if GPS Mode is either active or armed. Cancels LOC Mode if GPS Mode is active and LOC Mode is armed.
AP	Engages/disengages the autopilot.
LVL	Engages the autopilot (if the autopilot is disengaged) in level vertical and lateral modes
Nose Up / Nose Down	Adjusts the vertical mode reference in Pitch Hold, Vertical Speed, Indicated Airspeed, and Altitude Hold modes
IAS	Selects/deselects Indicated Airspeed Mode
ALT	Selects/deselects Altitude Hold Mode
VNAV	Selects/deselects vertical navigation
or	
APPR	Selects/deselects approach mode
VS	Selects/deselects Vertical Speed Mode
FD	Activates/deactivates the flight director only

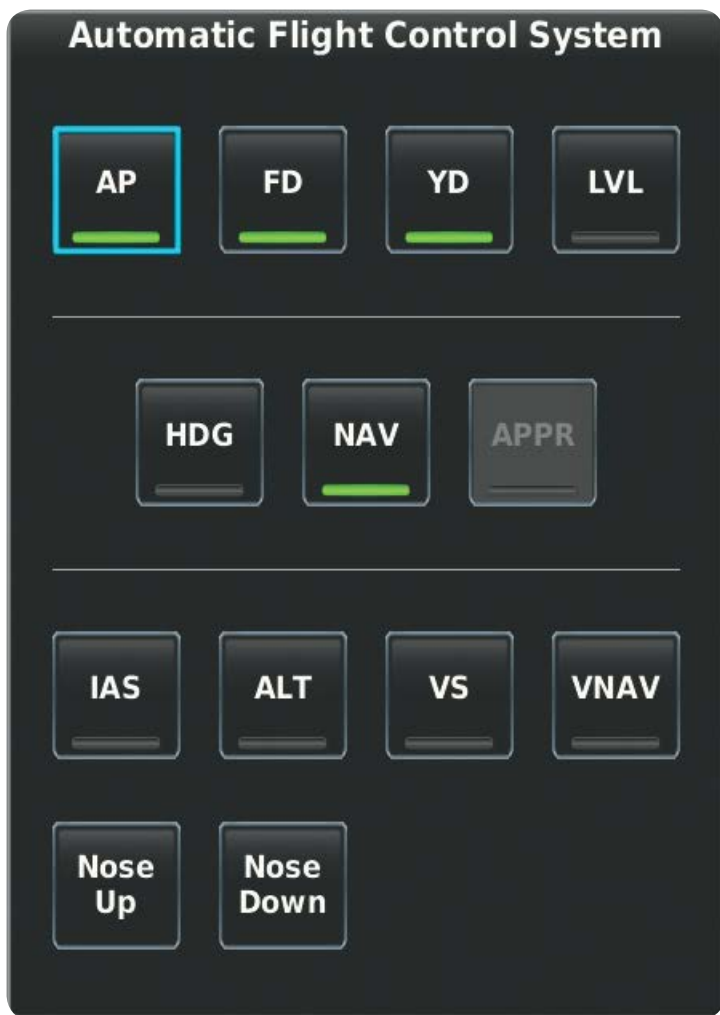

G3X Touch Autopilot

The following AFCS controls are located separately from the GDU and GMC 305/307 AFCS Control Unit:

**CWS/AP DISC Button  
(Autopilot Disconnect)**

An AP DISC/CWS Button is located on the pilot’s control stick. This button combines the functions of Autopilot Disconnect and Control Wheel Steering. (Note: the Control Wheel Steering function can be disabled in config mode, which causes the button to perform the Autopilot Disconnect function only)

Press and release the AP DISC/CWS Button to disengage the autopilot. Pressing and releasing the button again will acknowledge an autopilot disconnect alert and mute the associated aural tone.

Pressing and holding the AP DISC/CWS Button when the autopilot is engaged will temporarily disengage the pitch and roll servos and interrupt auto-trim operation. The pilot can then hand-fly the aircraft to a new attitude and release the AP DISC/CWS button to re-engage the autopilot servos and synchronize the flight director to the aircraft’s new attitude. The ability to use Control Wheel Steering may be disabled in config mode if desired.

If the configuration supports it, pressing and holding the AP DISC/CWS button while the autopilot is not engaged will cause the autopilot to engage. If the flight director was previously off, the default FD modes (PIT and ROL) will be selected. The ability to engage the autopilot using the CWS button may be disabled in config mode if desired.

**TO/GA Button  
(Takeoff/Go Around)**

Selects flight director Takeoff (on ground) or Go Around (in air) Mode

When properly configured with a GTN, if an approach procedure is loaded, this switch also activates the missed approach when the selected navigation source is GPS or when the navigation source is VOR/LOC and a valid frequency has been tuned.

**MET Switch  
(Manual Electric Trim)**

Used to command manual electric trim for any properly configured servo (pitch, roll, or yaw).

## ENGAGING THE AUTOPILOT

Selection of the control listed below (when the Autopilot is not engaged) will engage the Autopilot with the listed lateral and vertical modes (some modes may require an external navigator or NAV receiver):

Control	Modes Selected			
	Lateral		Vertical	
	Mode/Annunciation		Mode/Annunciation	
Autopilot Unit	Roll Hold	ROL	Pitch Hold	PIT
CWS Button (if equipped) (press and hold)	Roll Hold	ROL	Pitch Hold	PIT
<b>HDG</b>	Heading	HDG	Pitch Hold	PIT
<b>NAV</b>	Navigation	GPS VOR LOC	Pitch Hold	PIT
<b>ALT</b>	Roll Hold	ROL	Altitude Hold	ALT
<b>VS</b>	Roll Hold	ROL	Vertical Speed	VS
<b>VNAV</b>	Roll Hold	ROL	Vertical Navigation	VNAV
<b>APPR</b>	Approach	GPS LOC	Glidepath Glideslope	GP GS

### Engaging the Autopilot

Navigation and Approach Modes must have a valid VLOC signal or an active GPS course to activate the autopilot.

Vertical Navigation Mode must have an active flight plan and VNAV enabled to activate the autopilot.

### ENGAGING THE AUTOPILOT (GMC 305/307)

An initial press of the **AP** Key on the GMC 305/307 will activate the Flight Director and engage the autopilot in the default PIT and ROL modes.



## DISENGAGING THE AUTOPILOT

The Autopilot is manually disengaged by pushing the disconnect button on the autopilot unit, or by pressing the autopilot disconnect button on the control stick or yoke or by pressing the **AP** Key on the GMC 305/307. Manual disengagement is indicated by a five-second flashing yellow 'AP' annunciation and an aural alert. Cancel the aural alert by pressing and releasing the **AP/CWS** Button again (GSA 28 autopilot only)

Automatic disengagement is indicated by a flashing red 'AP' annunciation and an aural alert. Touch to acknowledge. Automatic disengagement occurs due to:

- System failure
- Invalid sensor data
- Inability to compute default autopilot modes

## DISENGAGING THE AUTOPILOT WHEN A MALFUNCTION IS SUSPECTED

If an autopilot failure or trim failure is suspected to have occurred, perform the following steps:

- 1) Firmly grasp the control wheel.
- 2) Press and hold the AP DISC Switch. The autopilot will disconnect and power is removed from the trim motor. Power is also removed from all primary servo motors and engaged solenoids. Note the visual and aural alerting indicating autopilot disconnect.
- 3) Retrim the aircraft as needed. Substantial trim adjustment may be needed.
- 4) Pull the appropriate circuit breaker(s) to electrically isolate the servo and solenoid components.
- 5) Release the AP DISC Switch.

## OVERPOWERING AUTOPILOT SERVOS

In the context of this discussion, “overpowering” refers to any pressure or force applied to the pitch controls when the autopilot is engaged. A small amount of pressure or force on the pitch controls can cause the autopilot automatic trim to run to an out-of-trim condition. Therefore, any application of pressure or force to the controls should be avoided when the autopilot is engaged.

Overpowering the autopilot during flight will cause the autopilot’s automatic trim to run, resulting in an out-of-trim condition or cause the trim to hit the stop if the action is prolonged. In this case, larger than anticipated control forces are required after the autopilot is disengaged.

The following steps should be added to the preflight check:

- 1) Check for proper autopilot operation and ensure the autopilot can be overpowered.
- 2) Note the forces required to overpower the autopilot servo clutches.

## FLIGHT DIRECTOR OPERATION

The flight director function provides pitch and roll commands to the pilot and autopilot, which are displayed on the PFD. With the flight director active, the aircraft can be hand-flown to follow the path shown by the Command Bars. The Flight Director has the following maximum commands: pitch (-15°, +20°) and roll (30°) angles.

### FLIGHT DIRECTOR SETUP

The Flight Director Setup Page allows the user to set the indicator type, TO/GA Pitch, and simplified flight director operation for certain modes.

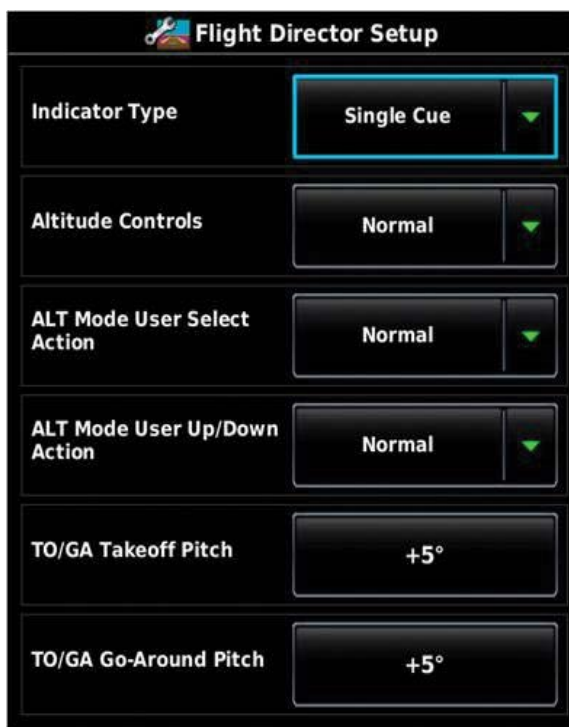

Flight Director Setup Page

## FLIGHT DIRECTOR INDICATOR TYPE

The Flight Director Indicator Type controls whether the flight director command indicator on the PFD uses a single-cue or dual-cue presentation.

### Setting the Flight Director Indicator Type:

- 1) From the PFD1, press the **MENU** Key twice to display the Main Menu.
- 2) Touch **Setup > Flight Director**.
- 3) In the Indicator Type field, touch **Single Cue** or **Dual Cue**.

## TO/GA TAKEOFF AND GO-AROUND PITCH



**NOTE:** TO/GA must be configured for the settings to appear. Refer to the *G3X Touch Installation Manual* for more information.

The TO/GA Takeoff and Go-Around Pitch settings control the pitch attitude targets used for TO and GA modes.

### Setting the TO/GA Takeoff and Go-Around Pitch:

- 1) From the PFD1, press the **MENU** Key twice to display the Main Menu.
- 2) Touch **Setup > Flight Director**.
- 3) In the TO/GA Takeoff Pitch or TO/GA Go-Around Pitch field, touch the desired pitch value.

## FLIGHT DIRECTOR ALTITUDE CONTROLS



**CAUTION:** The following settings change the Flight Director operation. Before changing these settings become familiar with how these changes affect the use of the Flight Director.

The Flight Director Altitude Controls allow the user to select **Normal** or **Simplified**. When Altitude Controls are set to **Normal**, the following additional selections appear:



Altitude Controls (Normal)

- ALT Mode User Select Action:** Determines the behavior of the Flight Director when the user selects Altitude Hold Mode by pressing the ALT key on the GMC 305/307, or touching the **ALT** button on the display. The following two options are available:

  - Normal:** The Flight Director enters Altitude Hold (ALT) Mode.
  - Sync Selected Altitude:** The Flight Director enters Altitude Hold (ALT) Mode and the Selected Altitude (Altitude Bug) changes to the current aircraft altitude.
- ALT Mode User Up/Down Action:** Determines the behavior of the Flight Director when the Flight Director is in Altitude Hold (ALT) Mode and the user moves the pitch wheel on the GMC 305/307, or touches **Nose Up** or **Nose Down** on the AFCS Display. The following two options are available:

  - Normal:** Adjusts the Target Altitude in 10-foot increments, up to +/-200 feet from the original Target Altitude.
  - Select VS Mode:** The Flight Director changes from Altitude Hold (ALT) Mode to Vertical Speed (VS) Mode and initiates a climb or descent. Subsequent vertical speed adjustments are in increments of 100 fpm. The Default Vertical Speed that is used for the initial climb or descent is set using a pair of fields that appear when **Select VS Mode** is selected.

- System Overview
- Flight Instruments
- EIS
- CNS Interface
- GPS Navigation
- Flight Planning
- Hazard Avoidance
- Additional Features
- AFCS
- Annun/Alerts
- Appendix
- Index

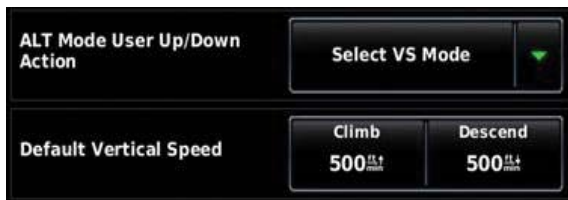

### ALT Mode User Up/Down Action (Select VS Mode)

When Altitude Controls are set to **Simplified**, Altitude Hold (ALT) Mode behavior differs in the following ways:



**NOTE:** With Altitude Controls set to **Simplified**, the user will not be able to pre-select a new altitude while ALT mode is already active.

- Selecting Altitude Hold (ALT) Mode causes the Selected Altitude (Altitude Bug) to change to the current aircraft altitude.
- There is no longer a difference between the Selected Altitude (Altitude Bug) and the Target Altitude for Altitude Hold (ALT) Mode.
- After Altitude Hold (ALT) Mode captures the Selected Altitude, subsequent changes to the Selected Altitude will cause ALT Mode to climb or descend towards the new Selected Altitude.
  - Subsequent vertical speed adjustments are in increments of 100 fpm, with the exception that the user cannot adjust the target vertical speed to a value that would cause the aircraft to fly away from the Selected Altitude.
  - Unlike **Select VS Mode** described previously, this option does not switch to VS mode. Instead, it displays a vertical speed bug.
  - The initial vertical speed used for climb or descent towards the new altitude is determined by the Default Vertical Speed fields as described previously.
- When Altitude Hold (ALT) Mode has captured the Selected Altitude, the vertical speed bug is removed and vertical speed adjustments have no effect.

## Setting the Flight Director Altitude Controls:



**NOTE:** *Flight Director Altitude Control settings cannot be changed when ALT mode is engaged. Turn off the Flight Director or switch to another vertical mode before attempting to set the Altitude Controls.*

- 1) From the PFD1, press the **MENU** Key twice to display the Main Menu.
- 2) Touch **Setup** > **Flight Director**.
- 3) In the Altitude Controls field, touch **Simplified** and enter the Default Vertical Speed value.

**Or:**

In the Altitude Controls field, touch **Normal**.

- a) In the ALT Mode User Select Action field, touch **Normal** or **Sync Selected Altitude**.
- b) In the ALT Mode User Up/Down Action field, touch **Normal**.

**Or:**

Touch **Select VS Mode** and enter the Default Vertical Speed value.

## ACTIVATING THE FLIGHT DIRECTOR USING THE GMC 305/307

An initial press of a key listed in the table below (when the flight director is not active) activates the flight director in the listed modes. The flight director may be turned off and the Command Bars removed from the display by pressing the **FD** Key again. The **FD** Key is disabled when the autopilot is engaged.

Control Pressed	Modes Selected			
	Lateral		Vertical	
<b>FD</b> Key	Roll Hold (default)	ROL	Pitch Hold (default)	PIT
<b>AP</b> Key	Roll Hold (default)	ROL	Pitch Hold (default)	PIT
<b>TO/GA</b> Button	Takeoff (on ground)Go Around (in air)	TO GA	Takeoff (on ground)Go Around (in air)	TO GA
<b>ALT</b> Key	Roll Hold (default)	ROL	Altitude Hold	ALT
<b>VS</b> Key	Roll Hold (default)	ROL	Vertical Speed	VS
<b>VNV</b> Key	Roll Hold (default)	ROL	Vertical Navigation*	VNAV
<b>IAS</b> Key	Roll Hold (default)	ROL	Indicated Airspeed	IAS
<b>APR</b> Key	Approach**	GPS VOR LOC	Pitch Hold (default)	PIT
<b>NAV</b> Key	Navigation**	GPS VOR LOC BC	Pitch Hold (default)	PIT
<b>HDG</b> Key	Heading Select	HDG	Pitch Hold (default)	PIT
<b>LVL</b> Key	Level Hold	LVL	Level Hold	LVL

\*Valid VNV flight plan must be entered before VNV Key press activates flight director.

\*\*The selected navigation receiver must have a valid VOR or LOC signal or active GPS course before NAV or APR Key press activates flight director.

### Flight Director Activation (GMC 305/307)



## FLIGHT DIRECTOR MODES

Flight director modes are normally selected independently for the pitch and roll axes. Unless otherwise specified, all mode keys are alternate action (i.e., press on, press off). In the absence of specific mode selection, the flight director reverts to the default pitch and/or roll modes.

Armed modes are annunciated in white and active in green in the AFCS Status Box. Under normal operation, when the control for the active flight director mode is pressed, the flight director reverts to the default mode(s) for the axis(es). Automatic transition from armed to active mode is indicated by the white armed mode annunciation moving to the green active mode field and flashing for 10 seconds.

If the information required to compute a flight director mode becomes invalid or unavailable, the flight director automatically reverts to the default mode for that axis. A flashing yellow mode annunciation and annunciator light indicate loss of sensor (ADC) or navigation data (VOR, LOC, GPS, VNAV) required to compute commands. When such a loss occurs, the system automatically begins to roll the wings level (enters Roll Hold Mode) or maintain the pitch angle (enters Pitch Hold Mode), depending on the affected axis. The flashing annunciation stops when the affected mode key is pressed or another mode for the axis is selected. If after 10 seconds no action is taken, the flashing annunciation stops.

The flight director is automatically disabled if the attitude information required to compute the default flight director modes becomes invalid or unavailable.



**Autopilot Manually Disengaged**

## COMMAND BARS

Upon activation of the flight director, Command Bars are displayed in magenta on the PFD. If the aircraft is being flown by hand, the command bars are displayed hollow. The Command Bars do not override the Aircraft Symbol. The Command Bars move together vertically to indicate pitch commands and bank left or right to indicate roll commands.

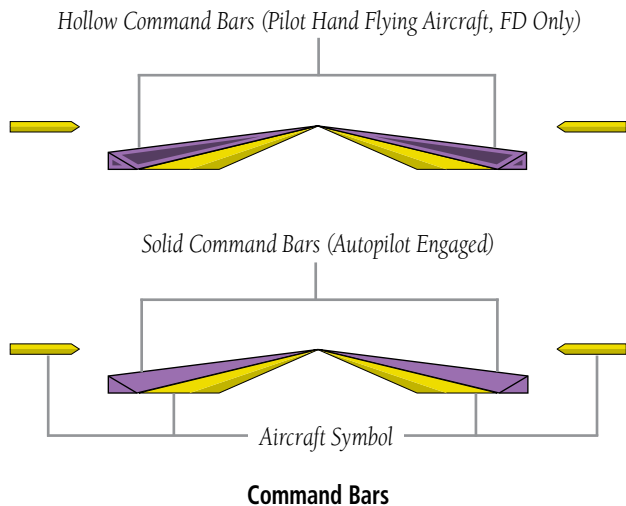

If the attitude information being sent to the flight director becomes invalid or unavailable, the Command Bars are removed from the display.

## 9.2 VERTICAL MODES

The table lists the vertical modes with their corresponding controls and annunciations. The mode reference is displayed next to the active mode annunciation for Altitude Hold, Vertical Speed, and Indicated Airspeed modes. The **NOSE UP/DN** Wheel (GMC 305/307 only), can be used to change the vertical mode reference while operating under Pitch Hold, Vertical Speed, Indicated Airspeed (GMC 305/307 only), or Altitude Hold modes. Increments of change of values for each of these references using the **NOSE UP/DN** Wheel, are also listed in the table.

Vertical Mode	Description	Control	Annunciation	Reference Change Increment
Pitch Hold	Holds the current aircraft pitch attitude; may be used to climb/descend to the Selected Altitude	(default)	PIT	0.5°
Selected Altitude Capture	Captures the Selected Altitude	*	ALTS	10 ft
Altitude Hold	Holds the current Altitude	<b>ALT</b> Key (GMC 305/307) or <b>ALT</b> G3X Touch	ALT    nnnnn FT	
Vertical Speed	Maintains the current aircraft vertical speed; may be used to climb/descend to the Selected Altitude	<b>VS</b> Key (GMC 305/307) or <b>VS</b> G3X Touch	VS    nnnn FPM	100 fpm

Vertical Mode	Description	Control	Annunciation		Reference Change Increment
Indicated Airspeed (IAS)	Maintains the current aircraft airspeed in IAS while the aircraft is climbing/descending to the Selected Altitude	<b>IAS</b> Key (GMC 305/307 only)	IAS	nnn KT	1 kt
Vertical Navigation	Captures and tracks descent legs of an active vertical profile	<b>VNV</b> Key (GMC 305/307) or <b>VNAV</b> G3X Touch	VNAV		
VNV Target Altitude Capture	Captures the Vertical Navigation (VNV) Target Altitude	**	ALTV		
Glidepath	Captures and tracks the SBAS glidepath on approach	<b>APR</b> Key (GMC 305/307) or <b>APPR</b> G3X Touch	GP		
Glideslope	Captures and tracks the ILS glideslope on approach		GS		
Takeoff	Commands a constant pitch angle and wings level on ground in preparation for takeoff	<b>GA</b> Button	TO		
Go Around	Commands a constant pitch angle and wings level in the air		GA		

\* *ALTS armed automatically when PIT, VS, IAS, or GA active, and under VNAV when Selected Altitude is to be captured instead of VNV Target Altitude*

\*\* *ALTV armed automatically under VNAV when VNV Target Altitude is to be captured instead of Selected Altitude*

### Flight Director Vertical Modes

## PITCH HOLD MODE (PIT)

When the flight director is activated (**FD** touched) or when the Autopilot is activated, Pitch Hold Mode is selected by default. Pitch Hold Mode is indicated as the active vertical mode by the green 'PIT' annunciation. This mode may be used for climb or descent to the Selected Altitude (shown above the Altimeter), since Selected Altitude Capture Mode is automatically armed when Pitch Hold Mode is activated.

In Pitch Hold Mode, the flight director maintains a constant pitch attitude. The pitch reference is set to the aircraft pitch attitude at the moment of mode selection. If the aircraft pitch attitude exceeds the flight director pitch command limitations, the flight director commands a pitch angle equal to the nose-up/down limit.

### CHANGING THE PITCH REFERENCE:

When operating in Pitch Hold Mode, the pitch reference can be adjusted by using the **NOSE UP/DN** Wheel (GMC 305/307 only) or by touching **Nose Up** or **Nose Down** on the G3X Touch.

Or

Hold the Control Wheel Steering (CWS) Button (if equipped, and the autopilot unit supports CWS), establish the desired pitch attitude, then release the CWS Button.



Pitch Hold & Selected Altitude Capture Modes

## SELECTED ALTITUDE CAPTURE MODE (ALTS)

Selected Altitude Capture Mode is automatically armed with activation of the following modes:

- Pitch Hold
- Vertical Speed
- Indicated Airspeed (GMC 305/307)
- TO/Go Around (GMC 305/307)
- Vertical Path Tracking (if the Selected Altitude is to be captured instead of the VNV Target Altitude)

The white 'ALTS' annunciation indicates Selected Altitude Capture Mode is armed. Touch the autopilot on the PFD and touch **ALT**. Use the large knob associated with the PFD and adjust the Selected Altitude until the Selected Altitude Capture Mode becomes active.

AP | ROL | VS ALTS

As the aircraft nears the Selected Altitude, the flight director automatically transitions to Selected Altitude Capture Mode with Altitude Hold Mode armed. This automatic transition is indicated by the green 'ALTS' annunciation flashing for up to 10 seconds and the appearance of the white 'ALTS' annunciation. The Selected Altitude is shown as the Altitude Reference beside the 'ALTS' annunciation.

*Automatic transition to ALTS  
Mode with ALT Mode armed*

AP | ROL | **ALTS** ALT

At 50 feet from the Selected Altitude, the flight director automatically transitions from Selected Altitude Capture to Altitude Hold Mode and holds the reference altitude. As Altitude Hold Mode becomes active, the white 'ALTS' annunciation moves to the active vertical mode field and flashes green for 10 seconds to indicate the automatic transition.

*Automatic transition to ALTS  
Mode with ALT Mode armed*

AP | ROL | **ALTS** ALT

### Setting the selected altitude (Integrated Autopilot Interface):

- 1) Touch the autopilot, and touch **ALT**.
- 2) Touch the Selected Altitude on the PFD, and use the keypad to enter the desired Selected Altitude.

### Setting the selected altitude (GMC 305/307):

- 1) Touch the autopilot, and touch **ALT** (or use the **ALT SEL Knob**, GMC 307 only).
- 2) Touch the Selected Altitude on the PFD, and use the keypad to enter the desired Selected Altitude.

Changing the Selected Altitude while Selected Altitude Capture Mode is active causes the autopilot to revert to Pitch Hold Mode with Selected Altitude Capture Mode armed for the new Selected Altitude.

## ALTITUDE HOLD MODE (ALT)

Altitude Hold Mode can be activated by touching **ALT** or **ALT** Key (GMC 305/307); the AFCS maintains the current aircraft altitude (to the nearest 10 feet) as the Altitude Reference. The Altitude Reference, shown in the G3X Touch Autopilot Status Box, is independent of the Selected Altitude, displayed above the Altimeter. Altitude Hold Mode active is indicated by a green 'ALT' annunciation in the G3X Touch Autopilot Status Box.

Altitude Hold Mode is automatically armed when in Selected Altitude Capture Mode. Selected Altitude Capture Mode automatically transitions to Altitude Hold Mode when within 50 feet of the Selected Altitude. In this case, the Selected Altitude becomes the Altitude Reference.

## CHANGING THE ALTITUDE REFERENCE

When operating in Altitude Hold Mode, the Altitude Reference can be adjusted in the following ways:

- The Altitude Reference can be adjusted up or down in 10-foot increments by **Nose Up** or **Nose Down** or rolling the **NOSE UP/DN** Wheel (GMC 305/307). Using this method, up to 200 feet of altitude change can be commanded. To change the Altitude Reference by more the 200 feet, use the CWS button (if equipped) as described below, or climb/descend using another vertical mode (PIT, VS) to capture the desired Selected Altitude.
- If the aircraft is equipped with a CWS Button, pressing the CWS Button allows the aircraft to be hand-flown to a new Altitude Reference. When the CWS Button is released at the desired altitude, the new altitude is established as the Altitude Reference.

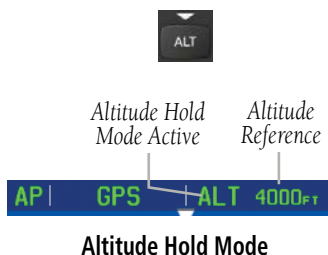

## VERTICAL SPEED MODE (VS)

In Vertical Speed Mode, the flight director acquires and maintains a Vertical Speed Reference. Current aircraft vertical speed (to the nearest 100 fpm) becomes the Vertical Speed Reference at the moment of Vertical Speed Mode activation. This mode may be used for climb or descent to the Selected Altitude (shown above the Altimeter) since Selected Altitude Capture Mode is automatically armed when Vertical Speed Mode is selected.

When Vertical Speed Mode is activated by pressing the **VS** Key (GMC 305/307) or touching **VS**, 'VS' is annunciated in green in the Autopilot Status Box along with the Vertical Speed Reference. The Vertical Speed Reference is also displayed above the Vertical Speed Indicator. A Vertical Speed Reference Bug corresponding to the Vertical Speed Reference is shown on the indicator.



## CHANGING THE VERTICAL SPEED REFERENCE

The Vertical Speed Reference may be adjusted in the following ways:

- Use the **NOSE UP/DN** Wheel (GMC 305/307) or touch the autopilot, touch **VS**, and touch **Nose Up** or **Nose Down** to adjust the Vertical Speed Reference in increments of 100 fpm. The current Vertical Speed Reference is displayed in the G3X Touch Autopilot Status Box for 10 seconds after a change is made and as a reference bug on the Vertical Speed Indicator.
- Press the CWS Button (if equipped) and hand-fly the aircraft to a new Vertical Speed Reference. When the CWS Button is released, the aircraft's vertical speed (to the nearest 100 fpm) is established as the new Vertical Speed Reference.

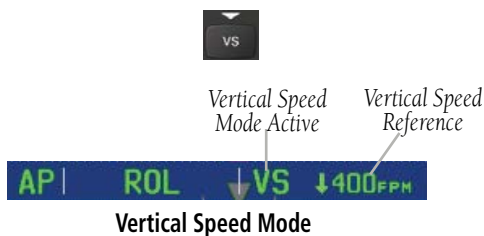

## INDICATED AIRSPEED MODE (IAS)

Indicated Airspeed Mode is selected by touching **IAS**. This mode acquires and maintains the Airspeed Reference (IAS) while climbing or descending. When Indicated Airspeed Mode is active, the flight director continuously monitors Selected Altitude, airspeed and altitude.

The Airspeed Reference is set to the current airspeed upon mode activation. Indicated Airspeed Mode is indicated by a green 'IAS' annunciation beside the Airspeed Reference in the Autopilot Status Box. The Airspeed Reference is also displayed as a light blue bug corresponding to the Airspeed Reference along the airspeed tape.

Engine power must be adjusted to allow the autopilot to fly the aircraft at a pitch attitude corresponding to the desired flight profile (climb or descent) while maintaining the Airspeed Reference.

## CHANGING THE AIRSPEED REFERENCE

The Airspeed Reference (shown in both the Autopilot Status Box and above the Airspeed Indicator) may be adjusted by using the **NOSE UP/DN** Wheel or by touching **Nose Up** or **Nose Down** in the AFCS Window.

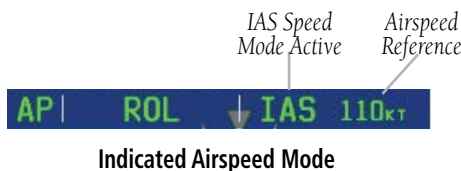

## VERTICAL NAVIGATION MODE (VNAV)



**NOTE:** If another vertical mode is touched while VNAV Mode is selected, VNAV Mode reverts to armed.



**NOTE:** Pressing the CWS Button (if equipped) while VNAV Mode is active does not cancel the mode. The autopilot guides the aircraft back to the descent path upon release of the CWS Button.

Vertical Navigation (VNAV) Mode is available for enroute/terminal cruise and descent operations any time that VNAV flight planning is available. Refer to Section 2.3 (Vertical Navigation) for more information.

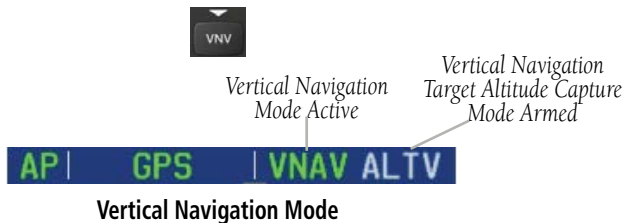

## Activating Vertical Navigation Mode:

- 1 When a flight plan is active, VNAV data is valid, and the **VNV** Key (GMC 305/307) or **VNAV** is selected on the G3X Touch, VNAV mode is armed in preparation for descent path capture. 'VNAV' is annunciated in white in the G3X Touch Autopilot Status Box. If applicable, the appropriate altitude capture mode is armed for capture of the VNAV Target Altitude (ALTV) or the Selected Altitude (ALTS), whichever is greater.
- 2 When a descent leg is captured (i.e., vertical deviation becomes valid), VNAV Mode is activated and tracks the descent profile. An altitude capture mode (ALTS or ALTV) is armed as appropriate.
- 3 When approaching the VNAV Target Altitude (or Selected Altitude) the system automatically transitions to ALTS or ALTV Mode with ALT Mode armed.

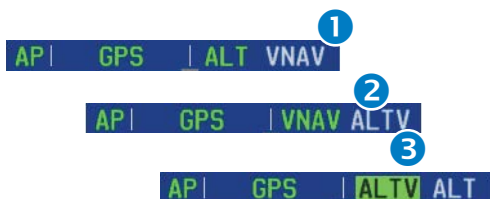

If the altimeter's barometric setting is adjusted while VNAV mode is active, the autopilot increases/decreases the descent rate by up to 500 fpm to re-establish the aircraft on the descent path (without commanding a climb). For large changes, it may take several minutes for the aircraft to reestablish on the descent path. If the change is made while nearing the VNAV waypoint, the aircraft may not reestablish on the descent path in time to level off at the VNAV Target Altitude. In this case, the autopilot will revert to Pitch Hold mode upon passing the VNAV waypoint, and Selected Altitude Capture (ALTV) mode will be automatically armed.

## AUTOMATIC REVERSION TO PITCH HOLD MODE

Several situations can occur while VNAV Mode is active which cause the AFCS to revert to Pitch Hold Mode:

- Vertical deviation exceeds 200 feet during an overspeed condition.
- Vertical deviation becomes invalid (the Deviation Indicator is removed from the PFD).

Following a reversion to Pitch Hold Mode, VNAV Mode and the appropriate altitude capture mode become armed to allow for possible profile recapture.

## VNAV TARGET ALTITUDE CAPTURE MODE (ALTV)

VNAV Target Altitude Capture is analogous to Selected Altitude Capture Mode and is armed automatically after the **VNV** Key (GMC 305/307) or **VNAV** is selected if the VNAV Target Altitude is to be intercepted before the Selected Altitude. The annunciation 'ALTV' indicates that the VNAV Target Altitude is to be captured. Refer to Section 2.3 (Vertical Navigation) for more information on setting up the VNAV target altitude.

As the aircraft nears the VNAV Target Altitude, AFCS automatically transitions to VNAV Target Altitude Capture Mode with Altitude Hold Mode armed. This automatic transition is indicated by the green 'ALTV' annunciation flashing for up to 10 seconds and the appearance of the white 'ALT' annunciation.

At 50 feet from the VNAV Target Altitude, the AFCS automatically transitions from VNAV Target Altitude Capture to Altitude Hold Mode and selects the VNAV target altitude as the new Autopilot Altitude Reference. As Altitude Hold Mode becomes active, the white 'ALT' annunciation moves to the active vertical mode field and flashes green for 10 seconds to indicate the automatic transition.

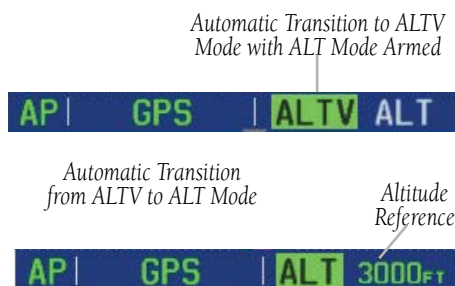

## GLIDEPATH MODE (GP) (WITH EXTERNAL WAAS ENABLED IFR NAVIGATOR ONLY)

Glidepath Mode is used to track a WAAS or other satellite-based augmentation system SBAS generated glidepath. When Glidepath Mode is armed, 'GP' is annunciated in white in the Autopilot Status Box.

### Selecting Glidepath Mode:

- 1) **EXTERNAL NAVIGATOR:** Ensure a GPS approach with vertical guidance (LPV, LNAV/VNAV, LNAV +V) is loaded into the active flight plan. The active waypoint must be part of the flight plan (cannot be a direct-to a waypoint not in the flight plan).
- 2) Ensure that GPS is the selected navigation source.
- 3) Press the **APR** Key (GMC 305/307) or touch the autopilot, then touch **APPR** (only available when an external GPS navigation source (i.e., GTN or GNS Series) is configured).



**NOTE:** Some RNAV (GPS) approaches provide a vertical descent angle as an aid in flying a stabilized approach. These approaches are NOT considered Approaches with Vertical Guidance (APV). Approaches that are annunciated on the HSI as LNAV or LNAV+V are considered Nonprecision Approaches (NPA) and are flown to an MDA even though vertical glidepath (GP) information may be provided.



**WARNING:** When flying an LNAV approach (with vertical descent angle) with the autopilot coupled, the aircraft will not level off at the MDA even if the MDA is set in the altitude preselect.

Upon reaching the glidepath, the flight director transitions to Glidepath Mode and begins to capture and track the glidepath.

Once the following conditions have been met, the glidepath can be captured:

- The active waypoint is at or after the final approach fix (FAF).
- Vertical deviation is valid.
- The CDI is at less than full-scale deviation
- Automatic sequencing of waypoints has not been suspended (no 'SUSP' annunciation on the HSI)

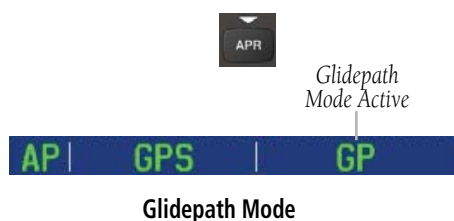

## GLIDESLOPE MODE (GS)

Glideslope Mode is available for LOC/ILS approaches to capture and track the glideslope. When Glideslope Mode is armed (annunciated as 'GS' in white), LOC Approach Mode is armed as the lateral flight director mode.

### Selecting Glideslope Mode:

- 1) EXTERNAL NAVIGATOR: Tune and activate the desired localizer frequency.
- 2) EXTERNAL NAVIGATOR: Ensure that LOC is the selected navigation source.
- 3) Press the **APR** Key (GMC 305/307) or touch the autopilot and touch **APPR**. This simultaneously selects LOC and GS (Glideslope) Modes.

**Or:**

- 1) EXTERNAL NAVIGATOR: Tune and activate the desired localizer frequency.
- 2) EXTERNAL NAVIGATOR: Load the approach (LOC, ILS, LDA, SDF, etc) into the flight plan.
- 3) Press the **APR** Key (GMC 305/307) or touch the autopilot and touch **APPR**. This simultaneously selects LOC and GS (Glideslope) Modes.

Once LOC is the navigation source, the localizer and glideslope can be captured. Upon reaching the glideslope, the flight director transitions to Glideslope Mode and begins to capture and track the glideslope.



AP | LOC | ALT GS

Glideslope Mode Armed

## GO AROUND (GA) AND TAKEOFF (TO) MODES

Go Around and Takeoff modes are coupled pitch and roll modes and are annunciated as both the vertical and lateral modes when active. In these modes, the flight director commands a constant set pitch attitude and keeps the wings level. The GA Switch is used to activate both modes. The mode entered by the flight director depends on whether the aircraft is on the ground or in the air.

Takeoff Mode provides an attitude reference during rotation and takeoff. This mode can be selected only while on the ground by pushing the **TO/GA** Button. The flight director Command Bars assume a wings-level, pitch-up attitude.

Pressing the **TO/GA** Button while in the air activates the flight director in a wings-level, pitch-up attitude, allowing the execution of a missed approach or a go around. Go Around Mode arms Selected Altitude Capture Mode automatically, and attempts to modify the aircraft attitude (i.e., with the **NOSE UP/DN** Wheel or **Nose Up/Nose Down**) result in reversion to Pitch and Roll Hold modes.



## 9.3 LATERAL MODES

The following table lists the lateral modes and respective control(s) and annunciation. Refer to the vertical modes section for information regarding Takeoff and Go Around Modes.

Lateral Mode	Description	Control	Annunciation
Roll Hold	Holds the current aircraft roll attitude or rolls the wings level, depending on the commanded bank angle	(default)	ROL
Heading Select	Captures and tracks the Selected Heading	<b>HDG</b> Key (GMC 305/307) or <b>HDG</b>	HDG
Navigation, GPS	Captures and tracks the selected navigation source (GPS, VOR, LOC)	<b>NAV</b> Key (GMC 305/307) or <b>NAV</b>	GPS
Navigation, VOR Enroute Capture/Track			VOR
Navigation, LOC Capture/ Track (No Glideslope)			LOC
Navigation, Backcourse Capture/Track			BC

Lateral Mode	Description	Control	Annunciation
Approach, GPS	Captures and tracks the selected navigation source (GPS, VOR, LOC)	<b>APR</b> Key (GMC 305/307) or <b>APPR</b>	GPS
Approach, VOR Capture/Track			VAPP
Approach, LOC Capture/Track (Glideslope Mode automatically armed)			LOC
Takeoff	Commands a constant pitch angle and wings level on ground in preparation for takeoff	<b>TO/GA</b> Button	TO
Go Around	Commands a constant pitch angle and wings level in the air		GA

*The AFCS limits turn rate to 3 degrees per second (standard rate turn).*

### Flight Director Lateral Modes

The CWS Button (if equipped) does not change lateral references for HDG or NAV modes. The autopilot guides the aircraft back to the Selected Heading/Course upon release of the CWS Button.

## ROLL HOLD MODE (ROL)



**NOTE:** If Roll Hold Mode is activated as a result of a mode reversion, the flight director rolls the wings level.

When the flight director is activated or switched, Roll Hold Mode is selected by default. This mode is annunciated as 'ROL' in the Autopilot Status Box. The current aircraft bank angle is held, subject to the bank angle condition.



Roll Hold Mode Annunciation

Bank Angle	Flight Director Response
< 6°	Rolls wings level
6 to 20°	Maintains current aircraft roll attitude
>20°	Limits bank to 20°

### Roll Hold Mode Responses

## CHANGING THE ROLL REFERENCE

When operating in Roll Hold Mode, the roll reference can be adjusted in the following ways:

- To decrease the roll reference, turn the inner knob associated with the PFD right. The AFCS slowly decreases the bank angle. The current bank angle is held (if the bank angle exceeds 6°). If the bank angle is less than 6°, the AFCS will roll the aircraft wings level.
- Hold the CWS Button (if equipped), establish the desired bank angle, then release the CWS Button.

## HEADING SELECT MODE (HDG)

Heading Select Mode is activated by touching the autopilot, then touching **HDG** or the **HDG** Key (GMC 305/307). Heading Select Mode acquires and maintains the Selected Heading. The Selected Heading is shown by a light blue bug on the HSI and in the box to the upper left of the HSI.

### CHANGING THE SELECTED HEADING

#### Changing the selected heading (Integrated Autopilot Interface):

- 1) Touch the Selected Heading on the PFD.
- 2) Enter the selected heading using the keypad and touch **Enter**.

#### Changing the selected heading (GMC 305/307):

- 1) Touch the Selected Heading on the PFD (or use the **HDG Knob**, GMC 307 only).
- 2) Enter the selected heading using the keypad and touch **Enter**.
- 3) Press the **HDG** Key on the GMC 305/307 to activate HDG Mode

Holding the CWS Button (if equipped) and hand-flying the aircraft does not change the Selected Heading. The autopilot guides the aircraft back to the Selected Heading upon release of the CWS Button.

Turns are commanded in the same direction as Selected Heading Bug movement, even if the Bug is turned more than 180° from the present heading (e.g., a 270° turn to the right). However, Selected Heading changes of more than 330° at a time result in turn reversals.



## NAVIGATION MODES (GPS, VOR, LOC, BC)



**NOTE:** The selected navigation receiver must have a valid VOR or LOC signal or active GPS course for the flight director to enter Navigation Mode.



**NOTE:** When intercepting a flight plan leg, the flight director gives commands to capture the active leg at approximately a 45° angle to the track between the waypoints defining the active leg. The flight director does not give commands fly to the starting waypoint of the active leg.



**NOTE:** When making a backcourse approach, set the Selected Course to the localizer front course.

Pressing the **NAV** Key or touching **NAV** on the G3X Touch selects Navigation Mode. Navigation Mode acquires and tracks the selected navigation source (GPS, VOR, LOC). The flight director follows GPS roll steering commands when GPS is the selected navigation source. When the navigation source is VOR or LOC, the flight director creates roll steering commands from the Selected Course and deviation. Navigation Mode can also be used to fly non-precision GPS and LOC approaches where vertical guidance is not required.

Backcourse Navigation Mode is selected when the localizer front course is greater than 105° from the aircraft heading. Backcourse Navigation Mode captures and tracks a localizer signal in the backcourse direction. The annunciation 'BC' in the Autopilot Status Box indicates Backcourse Navigation Mode.

If the Course Deviation Indicator (CDI) shows greater than one dot when the **NAV** Key is pressed or **NAV** is touched, the selected mode is armed. If the CDI is less than one dot, Navigation Mode is automatically captured when the **NAV** Key is pressed or **NAV** is touched. The armed annunciation appears in white to the left of the active roll mode.



When the CDI has automatically switched from GPS to LOC during a LOC/ILS approach, GPS Navigation Mode remains active, providing GPS steering guidance until the localizer signal is captured. LOC Navigation Mode is armed when the automatic navigation source switch takes place. If the **APR** Key is pressed or **NAV** is touched prior to the automatic navigation source switch, LOC Navigation Mode is armed.

If Navigation Mode is active and either of the following occur, the flight director reverts to Roll Hold Mode (wings rolled level):

- Different VOR tuned while in VOR Navigation Mode (VOR Navigation Mode reverts to armed)
- Navigation source manually switched
- During a LOC/ILS approach, the FAF is crossed while in GPS Navigation Mode after the automatic navigation source switch from GPS to LOC

LOC Mode is activated when the automatic navigation source switch takes place. If the **APR** Key is pressed or **APPR** is touched prior to the automatic navigation source switch, LOC Mode is armed.

In the right circumstances, LOC and GS Modes can be armed while GPS Mode is still active and the external navigator is set to GPS (not VLOC).

## Arming LOC & GS Modes while GPS Mode is still active:

- 1) EXTERNAL NAVIGATOR: Tune and activate the desired localizer frequency.
- 2) EXTERNAL NAVIGATOR: Load the approach (LOC, ILS, LDA, SDF, etc) into the flight plan.
- 3) G3X Touch: While GPS is still the selected navigation source on the external navigator, press the **APR** Key (GMC 305/307) or touch **APPR** to arm LOC and GS (Glideslope) Modes even with GPS Mode still active. The external navigator will switch from GPS to VLOC automatically and the G3X Touch will capture the localizer and then the glideslope.

If Navigation Mode is active and either of the following occur, the AFCS reverts to Roll Hold Mode (wings rolled level):

- Different VOR tuned while in VOR Navigation Mode (VOR Navigation Mode reverts to armed)
- Active navigation source manually switched • Active flight plan is deleted (only GPS-based modes)
- GPS reception is lost

If VOR Navigation Mode is active and the VOR signal is lost, the autopilot reverts to Roll Hold Mode (wings rolled level) and reverts VOR Mode to armed in the event the VOR signal is reestablished.

## OBS MODE

### Enabling/disabling OBS Mode (without external GPS navigator):

- 1) While navigating a flight plan or Direct-to, touch **CRS** on the PFD.
- 2) Touch **Yes** on the 'Set OBS and hold?' window.
- 3) Enter the desired course to/from the waypoint using the keypad and touch **Enter**.
- 4) To cancel OBS Mode and return to automatic waypoint sequencing, touch **OBS** on the PFD.
- 5) Touch **Release OBS Hold**.

### OR

- 1) From the Active Flight Plan Page press the **MENU** Key while navigating a flight plan or Direct-to.
- 2) Touch **Set OBS and Hold**.
- 3) Touch **Sync Course** or enter the desired course to/from the waypoint using the keypad and touch **Enter**.
- 4) To cancel OBS Mode and return to automatic waypoint sequencing, press the **MENU** Key.
- 5) Touch **Release Hold**.

### Enabling/disabling OBS Mode (with external GPS navigator configured):

- 1) Press the **OBS** Key on the external navigator. The 'Set OBS and Hold' Active Flight Plan Page menu option is now available.
- 2) From the Active Flight Plan Page press the **MENU** Key while navigating a flight plan or Direct-to.
- 3) Touch **Set OBS and Hold**.
- 4) Touch **Sync Course** or enter the desired course to/from the waypoint using the keypad and touch **Enter**.
- 5) To cancel OBS Mode and return to automatic waypoint sequencing, press the **MENU** Key.
- 6) Touch **Release Hold**.

## VOR MODE FOR NAVIGATION

VOR Mode can be used for navigation when an external navigation receiver is configured.

### Tracking Direct-to a VOR:

- 1) EXTERNAL NAVIGATOR: Tune and activate the desired VOR frequency. If a GTN or GNS series unit is not configured skip to Step 3.
- 2) EXTERNAL NAVIGATOR (GTN or GNS series units only): Ensure the 'VLOC' indication is showing in the lower-left corner. If not, press the CDI Key.
- 3) G3X Touch: Ensure that VOR1 or VOR2 is the selected navigation source. It should say 'VOR1' or 'VOR2' on the HSI and the needle should be green.
- 4) G3X Touch: From the PFD, touch the course on the PFD and touch **Sync Course**.
- 5) G3X Touch: Touch the autopilot on the PFD, then touch **NAV** to activate VOR Mode.

**Or:** Press the **NAV** Key on the GMC 305/307.

A green 'VOR' indication is displayed in the autopilot status bar and the autopilot tracks the selected course to the VOR.

### Intercepting and tracking a VOR radial:

- 1) EXTERNAL NAVIGATOR: Tune and activate the desired VOR frequency. If a GTN or GNS series unit is not configured skip to Step 3.
  - 2) EXTERNAL NAVIGATOR (GTN or GNS series units only): Ensure the 'VLOC' indication is showing in the lower-left corner of the. If not, press the CDI Key.
  - 3) G3X Touch: Ensure that VOR1 or VOR2 is the selected navigation source. It should say 'VOR1' or 'VOR2' on the HSI and the needle should be green.
  - 4) G3X Touch: From the PFD, touch the course on the PFD and touch **Sync Course**.
  - 5) G3X Touch: From the PFD, touch the autopilot and touch **NAV**.
- Or:** Press the **NAV** Key on the GMC 305/307.

If there is less than half-scale deviation when **NAV** is touched or the **NAV** Key is pressed, VOR Mode will activate (green text), intercept, and track the selected radial.



If there is more than half-scale deviation when **NAV** is touched, VOR Mode will arm (white text) first, then activate when closer to the radial.

## APPROACHES WITHOUT VERTICAL GUIDANCE



**NOTE:** The selected navigation receiver must have a valid VOR or LOC signal or active GPS course for the flight director to enter Approach Mode.



**NOTE:** For the autopilot to enter a VLOC mode, the G3X Touch must have GPS reception, a valid navigation database, and the external navigation receiver must have a valid signal (VOR or LOC).

Touch **NAV** or press the **NAV** Key (GMC 305/307) to arm/activate VOR, LOC/BC, and GPS (LNAV only) lateral modes. Lateral modes acquire and track the selected navigation source (GPS, VOR, or LOC), depending on the loaded approach. These modes use the selected navigation receiver deviation and desired course inputs to fly the approach. Touch **NAV** when the CDI is greater than one dot to arm the selected modes (annunciated in white). Touch **NAV** when the CDI deviation is less than one dot to activate, capture and track the selected navigation source (GPS, VOR, or LOC).

Example	Control	Lateral Mode	Annunciation	Description
LNAV	<b>NAV</b> Key (GMC 305/307)  <b>or</b> <b>NAV</b>	Approach, GPS	GPS	Captures and tracks the selected navigation source (GPS, VOR, LOC)
VOR		VOR Approach Capture/Track	VOR	
LOC		LOC Capture/Track (No Glideslope)	LOC	
BC		Backcourse Capture/Track	BC	Captures and tracks a localizer signal for backcourse approaches

Approaches without Vertical Guidance

## GPS APPROACH WITHOUT VERTICAL GUIDANCE

A GPS approach without vertical guidance (LNAV) is flown using GPS NAV Mode.

### Selecting a GPS Approach without vertical guidance:

- 1) EXTERNAL NAVIGATOR: Ensure a GPS approach without vertical guidance (LNAV) is loaded into the active flight plan.
  - 2) EXTERNAL NAVIGATOR: Ensure the 'GPS' indication is showing in the lower-left corner. If not, press the CDI Key.
  - 3) G3X Touch: Ensure that GPS1 is the selected navigation source on the PFD.
  - 4) EXTERNAL NAVIGATOR: Select and activate the GPS approach using the PROC Key.
  - 5) G3X Touch: From the PFD touch the autopilot and touch **NAV** to activate GPS Mode.
- Or:** Press or the **NAV** Key on the GMC 305/307
- 6) Adjust the aircraft's pitch axis as required.

## VOR APPROACH

A VOR approach is flown using VOR Mode.

### Selecting a VOR Approach:

- 1) EXTERNAL NAVIGATOR: Tune and activate the desired VOR frequency. If a GTN or GNS series unit is not configured skip to Step 3.
  - 2) EXTERNAL NAVIGATOR (GTN or GNS series units only): Ensure the 'VLOC' indication is showing in the lower-left corner of the. If not, press the CDI Key.
  - 3) G3X Touch: Ensure that VOR1 or VOR2 is the selected navigation source. It should say 'VOR1' or 'VOR2' on the HSI and the needle should be green.
  - 4) G3X Touch: From the PFD touch the autopilot and touch **CRS**. Select the inbound approach course (radial).
  - 5) G3X Touch: From the PFD, touch the autopilot and touch **NAV**.
- Or:** Press or the **NAV** Key on the GMC 305/307

If there is less than half-scale deviation when touching **NAV** or when the **NAV** Key is pressed, VOR Mode will activate (green text), intercept, and track the selected radial. If there is more than half-scale deviation when

**NAV** is touched or when the **NAV** Key is pressed, VOR Mode will arm (white text) first, then activate when closer to the radial.

- 6) Adjust the aircraft's pitch axis as required.

## LOCALIZER APPROACH (NO GS)

LOC Mode is used to fly a localizer only approach (no glideslope).

### Selecting LOC Mode for a localizer only approach:

- 1) EXTERNAL NAVIGATOR: Tune and activate the desired LOC frequency,
- 2) G3X Touch: Ensure that LOC1 is the selected navigation source. The HSI should automatically slew the needle to the correct course.
- 3) G3X Touch: From the PFD, touch the autopilot and touch **NAV** to activate LOC Mode.

**Or:** Press or the **NAV** Key on the GMC 305/307

If the localizer deviation is less than half-scale when **NAV** is touched or when the **NAV** Key is pressed, the autopilot will activate LOC Mode and track the localizer, otherwise LOC Mode is armed and the pilot is responsible for intercepting the localizer. In some cases it may be necessary to use HDG Mode with LOC Mode armed to follow a vector to the localizer.

## BACKCOURSE APPROACH



---

**NOTE:** When making a backcourse approach, set the Selected Course to the localizer front course.

---



---

**NOTE:** 'BC' will not be displayed on the G3X Touch HSI.

---

Backcourse Mode captures and tracks a localizer signal in the backcourse direction. Backcourse is indicated by 'BC' in the autopilot status box.

If GS and LOC Mode are armed, the autopilot can only capture the localizer front course, indicated by 'LOC' in the autopilot status box. If only LOC Mode is armed (not GS Mode), the autopilot will capture either the front course or the backcourse based on the angle at which the aircraft intercepts the localizer.

## Selecting BC Mode:

- 1) EXTERNAL NAVIGATOR: Tune and activate the desired LOC frequency.
- 2) G3X Touch: Ensure that LOC1 is the selected navigation source on the. The HSI should automatically slew the needle to the correct course.
- 3) G3X Touch: From the PFD touch the autopilot then touch **NAV**.

**Or:** Press or the **NAV** Key on the GMC 305/307

If the aircraft heading is within 75° of the localizer backcourse then BC Mode will be armed. If the aircraft heading is within 105° of the localizer front course, LOC Mode will be armed.

## APPROACHES WITH LATERAL + VERTICAL GUIDANCE

Touch **APPR** or press the **APR** Key (GMC 305/307.) to arm/activate both lateral and vertical modes for approach. When Glidepath (GP) Mode is armed for a GPS approach with vertical guidance, GPS Mode is automatically armed. When Glideslope (GS) Mode is armed for an ILS approach, LOC Mode is automatically armed. Touch **APPR** or press the **APR** Key (GMC 305/307) when the CDI is greater than one dot to arm the selected modes (annunciated in white). Touch **APPR** or press the **APR** Key (GMC 305/307) when the CDI deviation is less than one dot to activate, capture and track the selected navigation source.

Example	Control	Modes	Annunciation	Description
LPV, LNAV/ VNAV, LNAV+V	<b>APR</b> Key (GMC 305/307)  or <b>APPR</b>	Lateral: GPS	GPS	Captures and tracks the lateral portion of a GPS approach
		Vertical: Glidepath	GP	Captures and tracks a WAAS approach glidepath
LOC, ILS, LDA, SDF	<b>APR</b> Key (GMC 305/307)  or <b>APPR</b>	Lateral: Localizer	LOC	Captures and tracks the localizer
		Vertical: Glideslope	GS	Captures and tracks the glideslope

### Lateral + Vertical Approaches

## GPS APPROACH WITH VERTICAL GUIDANCE



**NOTE:** To cancel Glidepath (GP) Mode without cancelling GPS Mode, **NAV** once. Pressing it a second time cancels GPS Mode.

When Glidepath (GP) Mode is armed for a GPS approach with vertical guidance, GPS Mode is automatically armed.

### Selecting a GPS approach with vertical guidance:

- 1) EXTERNAL NAVIGATOR: Ensure a GPS approach with vertical guidance (LPV, LNAV/VNAV, LNAV+V) is loaded into the active flight plan.
  - 2) EXTERNAL NAVIGATOR: Ensure the 'GPS' indication is showing in the lower-left corner. If not, press the CDI Key.
  - 3) G3X Touch: Ensure that GPS1 is the selected navigation source on the PFD.
  - 4) EXTERNAL NAVIGATOR: Select and activate the GPS approach using the PROC Key.
  - 5) G3X Touch: From the PFD touch the autopilot then touch **APPR**.
- Or** Press the **APR** Key on the GMC 305/307

## LOCALIZER WITH GLIDESLOPE

LOC Mode (lateral) and GS Mode (vertical) are both armed by touching **APPR** from the G3X Touch PFD or by pressing the **APR** Key on the GMC 305/307. LOC/ILS approach captures are inhibited if the difference between aircraft heading and localizer course exceeds 105°.



**NOTE:** To cancel Glideslope (GS) Mode without cancelling LOC Mode, touch **NAV** once. Pressing it a second time cancels LOC Mode.

### Selecting LOC Mode with GS Mode:

- 1) EXTERNAL NAVIGATOR: Tune and activate the desired LOC frequency.
  - 2) G3X Touch: Ensure that LOC1 is the selected navigation source. The HSI should automatically slew the needle to the correct course.
  - 3) G3X Touch: From the PFD touch the autopilot then touch **APPR**.
- Or:** Press the **APR** Key on the GMC 305/307

This simultaneously selects LOC Mode and GS (Glideslope) Mode. If the localizer deviation is less than half-scale when touching **APPR** or the **APR** Key is pressed, the autopilot will activate LOC Mode and track the localizer, otherwise LOC Mode is armed and the pilot is responsible for intercepting the localizer.

If the following occurs, the autopilot reverts to Roll Hold Mode (wings rolled level):

- Approach Mode is active and the Navigation source is manually switched
- The localizer signal is lost

If the Glideslope signal is lost, GS Mode will revert to Pitch Hold Mode and hold the last pitch attitude.

## COUPLED ILS APPROACH WITH PROCEDURE TURN



**NOTE:** Configuration of a GNS 430 or GNS 530 is required for a coupled ILS approach.

The external navigator (GNS 430/530), G3X Touch, and autopilot can be used to fly a full ILS approach with procedure turn, from the enroute environment to the missed approach point.

### Setting up a coupled ILS approach:

- 1) **EXTERNAL NAVIGATOR:** Ensure the 'GPS' indication is showing in the lower-left corner. If not, use the CDI Key.
- 2) **G3X Touch:** Ensure that GPS1 is the selected navigation source on the PFD.
- 3) **EXTERNAL NAVIGATOR:** Select and activate the ILS approach using the PROC Key.
- 4) **G3X Touch:** From the PFD touch the autopilot and touch **NAV** to activate GPS Mode. The autopilot should start navigating to the IAF (Initial Approach Fix).

**Or:** Press the **NAV** Key on the GMC 305/307

- 5) **EXTERNAL NAVIGATOR:** Tune and identify the localizer frequency by pressing the VLOC Flip-flop Key. (Note: The external navigator should have automatically loaded the localizer frequency into the standby VLOC slot.)
- 6) **G3X Touch:** From the PFD touch the autopilot and touch **APPR** to arm LOC and GS modes. Touch **ALT**.

**Or:** Press the **APR** Key on the GMC 305/307

GPS Mode is now active and LOC Mode is armed in the roll axis. ALT Mode is active and GS is armed in the pitch axis. The autopilot should now navigate the entire approach from the IAF (Initial Approach Fix) to the MAP (Missed Approach Point) with the only adjustment being the throttle.



**NOTE:** Check step #5 if the external navigator doesn't automatically switch from GPS to VLOC Mode shortly after turning inbound on the final approach course.

## INTERCEPTING AND FLYING A DME ARC

The AFCS will intercept and track a DME arc that is part of the active flight plan provided that GPS Navigation Mode is engaged, GPS is the active navigation source on the CDI, and the DME arc segment is the active flight plan leg. It is important to note that automatic navigation of DME arcs is based on GPS. Thus, even if the APR key is pressed and LOC or VOR Approach Mode is armed prior to reaching the Initial Approach Fix (IAF), Approach Mode will not activate until the arc segment is completed.

If the pilot decides to intercept the arc at a location other than the published IAF (i.e. ATC provides vectors to intercept the arc) and subsequently selects Heading Mode or Roll Mode, the AFCS will not automatically intercept or track the arc unless the pilot activates the arc leg of the flight plan and arms GPS Navigation Mode. The AFCS will not intercept and fly a DME arc before reaching an IAF that defines the beginning of the arc segment. Likewise, if at any point while established on the DME arc the pilot deselects GPS Navigation Mode, the AFCS will no longer track the arc.

## LEVEL MODE (GMC 305/307 ONLY)

Level Mode is coupled in pitch and roll modes and is annunciated as both the vertical and lateral modes when active. Pressing the **LVL** Key engages the autopilot in Level vertical and lateral modes. Level Mode does not track altitude or heading. When the **LVL** Key is pressed all armed and active modes are cancelled and the autopilot and flight director revert to LVL mode for pitch and roll. While in level mode, all other modes are available by pressing the corresponding button.

- System Overview
- Flight Instruments
- EIS
- CNS Interface
- GPS Navigation
- Flight Planning
- Hazard Avoidance
- Additional Features
- AFCS**
- Annun/Alerts
- Appendix
- Index

Blank Page



# SECTION 10 ANNUNCIATIONS & ALERTS

## 10.1 MISCELLANEOUS MESSAGE ADVISORIES

Message	Comments
<b>Approaching Target Altitude</b>	Within 200 feet of final VNAV target altitude.
<b>Approaching VNAV Profile</b>	The aircraft is within one minute of reaching the initial VNAV descent point.
<b>Arriving at XXX</b>	The aircraft is nearing the destination.
<b>Can't Unlock Maps</b>	No applicable unlock code for one or more maps was found. All MapSource maps are not accessible.
<b>Database Error</b>	Internal problem with the system. Contact your dealer or Garmin Product Support to have the unit repaired.
<b>Fuel Tank</b>	A reminder for switching fuel tanks. The reminder message repeats at the specified interval after the beginning of each trip.
<b>Lost Satellite Reception</b>	The system is unable to receive satellite signals.
<b>Memory Full</b>	System memory is full, no further data can be saved.
<b>Proximity Alarm XXXXX</b>	You have reached the distance set for a proximity waypoint.
<b>Next DTK XXX</b>	The aircraft is nearing a turn in a route.
<b>No XM Signal</b>	The XM antenna is not receiving a signal.
<b>Proximity Alarm Memory Full</b>	No additional proximity waypoints can be saved.
<b>Proximity Waypoints Overlap</b>	The radius of two proximity waypoints overlap.
<b>Route Already Exists</b>	A route name that already exists has been entered.
<b>Route Memory Full</b>	No additional routes can be saved.
<b>Route Truncated</b>	Uploaded route from another device has more than 300 waypoints.
<b>Route Waypoint Memory Full</b>	No additional route waypoints can be saved.
<b>Saving XM Program Information</b>	An XM Radio channel lineup change has occurred and the unit is saving the channel lineup to memory.

System Overview

Flight Instruments

EIS

CNS Interface

GPS Navigation

Flight Planning

Hazard Avoidance

Additional Features

AFCS

Annun/Alerts

Appendix

Index

Message	Comments
<b>Steep Turn Ahead</b>	Approaching a turn that requires a bank angle in excess of 25 degrees to stay on course.
<b>Track Already Exists</b>	A saved track with the same name already exists.
<b>Track Log Full</b>	The track log is full and track recording was turned off. To record more track points, you need to clear the track log and turn track recording on.
<b>Track Memory Full</b>	No more track data can be stored. Delete the old track data to store the new data.
<b>Track Truncated</b>	A complete uploaded track will not fit in memory. The oldest track log points have been deleted.
<b>Transfer Complete</b>	Data transfer was completed.
<b>VNAV Cancelled</b>	VNAV function has been cancelled due to a change in the active route.
<b>Waypoint Already Exists</b>	A waypoint with the same name already exists.
<b>Waypoint Memory Full</b>	The unit has stored the maximum number of waypoints.

### Miscellaneous Message Advisories

## AIRSPACE MESSAGES

Message	Comments
<b>Inside Airspace</b>	Inside the boundaries of the airspace.
<b>Airspace Near and Ahead</b>	Within two nautical miles of an airspace and your current course takes you inside the airspace.
<b>Airspace Ahead, Within 10 Minutes</b>	The projected course takes you inside an airspace within the next 10 minutes or less.
<b>Airspace Near, Within 2 nm</b>	Within two nautical miles of an airspace but not projected to enter it.

## 10.2 SYSTEM STATUS MESSAGES

A yellow (Messages) alert will flash at the bottom of the display.



Message Alert

### Accessing messages:

- 1) Touch **Messages** at the bottom of the screen to view messages.
- 2) Touch **Messages** again to remove the messages.

## SYSTEM STATUS MESSAGES

Message	Comments
<b>[LRU name] hardware fault</b>	The specified LRU has a hardware fault and requires service.
<b>Config module error</b>	The GDU has encountered a problem writing to/ from the config module. The G3X Touch system should be serviced.
<b>Config module missing</b>	The PFD1 config module is not connected.
<b>[LRU name] using backup RS-232 interface</b>	The specified LRU was wired for both CAN and RS-232 communication paths, and the device is not communicating via CAN.
<b>[LRU name] temperature out of spec</b>	The specified LRU is either too hot or too cold. Check installation and/or hardware for cause.
<b>[LRU name] power supply fault</b>	The specified LRU's internal power supply has a problem or the input voltage is out of the required specifications.
<b>AHRS [number] not calibrated</b>	The specified AHRS is either not calibrated or requires the post installation calibration procedure. See G3X Touch installation manual for calibration instructions.
<b>AHRS [number] magnetometer not calibrated</b>	The specified AHRS is either not calibrated or requires the magnetometer post installation calibration procedure. See G3X Touch installation manual for calibration instructions.
<b>AHRS [number] not receiving magnetometer data</b>	The specified AHRS is not receiving magnetometer data. Check installation and configuration.
<b>AHRS [number] not receiving air data</b>	The specified AHRS is not receiving air data. Check installation and configuration.
<b>AHRS [number] not receiving GPS data</b>	The specified AHRS is not receiving any or any useful GPS information. Check installation and configuration.

Message	Comments
<b>AHRS [number] magnetic anomaly - check mag installation</b>	An anomaly has been detected in the magnetometer data. Heading may or may not be flagged invalid.
<b>AHRS [number] magnetic field model invalid</b>	The data being communicated by the GMU to the specified AHRS is invalid. Heading is flagged invalid and the AHRS will use GPS for backup mode operation.
<b>AHRS [number] model out of date</b>	The specified AHRS Earth magnetic field model is out of date. Update magnetic field model when practical.
<b>Network communication error</b>	Two or more LRUs may have the same network address. Check wiring and configuration.
<b>[LRU name] Network address changed</b>	One or more LRUs on the CAN bus have an indeterminate network address. This likely indicates a wiring issue or an intermittent connector pin. If the problem persists, the G3X Touch system should be serviced.
<b>[GDU name] software version mismatch</b>	The PFD and MFD do not have the same software version installed. Display crosstalk is disabled. Ensure all installed display software matches.
<b>[GDU name] obstacle database mismatch</b>	The PFD and MFD have different obstacle database versions installed. Install the correct obstacle database on all displays for proper terrain/obstacle alerting.
<b>[GDU name] obstacle database missing</b>	The obstacle database is missing. Install the correct obstacle database on all displays for proper terrain/obstacle alerting.
<b>[GDU name] terrain database mismatch</b>	The PFD and MFD have different terrain database versions installed. Install the correct terrain database on all displays for proper terrain/obstacle alerting.

- System Overview
- Flight Instruments
- EIS
- CNS Interface
- GPS Navigation
- Flight Planning
- Hazard Avoidance
- Additional Features
- AFCS
- Annun Alerts
- Appendix
- Index

Message	Comments
<b>[GDU name] terrain database missing</b>	The terrain database is missing. Install the correct terrain database on all displays for proper terrain/obstacle alerting.
<b>[GDU name] navigation database mismatch</b>	The PFD and MFD have different navigation database versions installed. Install the correct navigation database on all displays for proper navigation.
<b>[GDU name] navigation database missing</b>	The navigation database is missing. Install the correct navigation database on all displays for proper navigation.
<b>[GDU name] audio database missing.</b>	The audio database is missing. Return unit for service
<b>[GDU name] audio database incompatible</b>	The audio database is incompatible. Return unit for service
<b>Using external GPS position data</b>	The display that is configured for a GPS antenna connection is not available; the remaining displays are using 2D GPS position data from an external GPS navigator.
<b>[GDU name] GPS antenna not connected</b>	The display that is configured for a GPS antenna connection does not detect any antenna current draw from the GPS antenna RF connector.
<b>[GDU name] GPS antenna shorted to ground</b>	The display that is configured for a GPS antenna connection detects the GPS antenna RF connector is shorted to ground.
<b>[GDU name] GPS receiver needs service</b>	The internal GPS receiver in the specified GDU is not responding. The affected GDU should be serviced.
<b>XM receiver needs service</b>	The display should be serviced when possible.
<b>Not receiving external GPS [number] RS-232 Aviation data</b>	Not receiving RS-232 data from the specified external GPS navigator.
<b>Not receiving GTX TIS-A RS-232 data</b>	Not receiving RS-232 data from the GTX.

Message	Comments
<b>Not receiving nav/comm [number] RS-232 data</b>	Not receiving RS-232 data from the nav/comm.
<b>Not receiving autopilot RS-232 data</b>	Not receiving RS-232 data from the external third-party autopilot unit.
<b>Autopilot fault detected</b>	The third-party autopilot unit is reporting a fault and needs service.
<b>VHF nav/comm communication error</b>	Incorrect OBS value received from nav/comm. Check nav/comm OBS resolver setup (see Installation Manual guidance).
<b>Not receiving ARINC 429 [port number] data</b>	Data is not being received on the specified GSU 73 ARINC 429 input (port number can be 1-4).
<b>ARINC 429 receiver error</b>	Data received on an ARINC 429 input does not match the expected configuration.
<b>Not receiving Vertical Power RS-232 data</b>	Not receiving RS-232 data from the Vertical Power unit.
<b>Using internal flight plan for navigation</b>	Communication with the external GPS navigation source has failed. The G3X Touch internal flight plan is being used for navigation.
<b>Aviation waypoint was deleted</b>	A waypoint that was part of a stored flight plan was deleted from the latest navigation database. Check stored flight plans
<b>Aviation waypoint has moved</b>	A waypoint that was part of a stored flight plan was moved. Check stored flight plans.
<b>Demo Mode - Do not use for navigation</b>	The system is in demo mode, do not use for navigation.

## 10.3 AUDIO ALERTS

### VOICE ALERTS

- “Five Hundred”—when the aircraft descends through 500 feet above the destination airport.

The following voice terrain alerts are issued when flight conditions meet parameters that are set within the software algorithms, and are dependent on the sensitivity level set in the Terrain Setup Menu.

Alert Severity	Terrain	Obstacle	Descent Rate
<b>Caution</b>	“caution, terrain” “caution, terrain ahead”	“caution, obstacle” “caution, obstacle ahead”	“caution, sink rate”
<b>Warning</b>	“terrain ahead! pull up!” “terrain! terrain! pull up! pull up!”	“obstacle ahead! pull up!” “obstacle! obstacle! pull up! pull up!”	“sink rate, pull up!” “pull up!”

Voice Alerts Summary

### AOA AURAL ALERT

When a G3X Touch is configured with a GSU 25, a GAP 26 and AOA is configured. The G3X Touch will issue an aural alert when the aircraft’s pitch attitude approaches a stall. A persistent beeping will begin at the first red chevron and will become progressively faster as the AOA is increased. A constant tone will be heard at the second red chevron indicating a stall condition.



Angle of Attack Display (AOA)



## 10.4 PFD ANNUNCIATIONS AND ALERTING FUNCTIONS

The following annunciations and alerting functions are displayed on the PFD.

### CAS MESSAGES (OPTIONAL)

The CAS messages displayed depend upon the current configuration, and will vary from the examples listed below. Refer to the G3X Touch Installation Manual for more information on configuring CAS messages (if applicable).

CAS Messages are grouped by criticality (warning, caution, advisory, and safe):

- **WARNING (red):** Requires immediate attention. Warning messages will flash until acknowledged by pressing the **BACK** Key or touching the on-screen message.
- **CAUTION (yellow):** Requires pilot awareness and possible future corrective action.
- **ADVISORY (white):** Provides general information.
- **SAFE (green):** Indicates a safe condition (i.e., GEAR DOWN).

Warning annunciation text is shown in red in the CAS Annunciation Window on the full-screen PFD and/or split-screen PFD Page.

CAS Messages will appear to the right of the Horizontal Situation Indicator (dependent on number of CAS messages configured). Touch on an active CAS message to acknowledge it.

### TERRAIN ANNUNCIATIONS

In addition to the Terrain Pop-up Alert in the lower left corner of the page, terrain and obstacle annunciations appear on the PFD in the upper left corner of the Attitude Indicator. Refer to the Hazard Avoidance Section for more details.

### TRAFFIC ANNUNCIATIONS

The G3X Touch displays traffic symbolically on the Map Page, and the Traffic Warning Window (Inset Map) in the lower left corner of the GDU 46X display(s). Refer to the Hazard Avoidance Section and the Annunciations and Alerts section for more details.

## AHRS ALERTS (OPTIONAL)

Multiple ADAHRS units may be installed to provide redundancy for critical flight data. If the PFD ADAHRS source selection is set to **Auto**, and attitude or air data from the default ADAHRS source becomes unavailable, the PFD will automatically switch to using attitude and air data from another valid ADAHRS source. The selected ADAHRS source can also be manually changed by the pilot. In either case, a message appears on the PFD to indicate that an alternate source of attitude and air data is being used (e.g. 'USING AHRS2').



USING AHRS2  
USING ADC2

Reversionary Sensor Window

If a standby flight display is present, and all installed ADAHRS sources are unavailable, the messages 'AHRS REVERT' and 'ADC REVERT' will appear. These messages indicate that the PFD has reverted to using attitude and air data from the standby flight display instead of a dedicated ADAHRS unit.

Critical values generated by redundant sensors are monitored by comparators. If differences in the sensors exceed a specified amount, the Comparator Window appears in the lower right corner of the PFD and the discrepancy is annunciated in the Comparator Window as a 'MISCOMP' (mismatch). If one or both of the sensed values are unavailable, it will be annunciated as a 'NO COMP' (no compare).



ATT NO COMP  
HDG NO COMP  
IAS NO COMP  
ALT NO COMP

Comparator Window

If the ADAHRS source selection is set to **Auto** and an attitude mismatch condition is detected, the flight director cannot be engaged until the pilot determines which source of attitude data should be used. When the pilot selects a specific ADAHRS source other than **Auto**, the flight director and autopilot may be used (or re-engaged) even if the mismatch condition persists.

## AFCS ALERTS (OPTIONAL)



AFCS Alerts

## STATUS ALERTS

If the commanded operation cannot be achieved due to the limitations configured, the following messages can be displayed over the pitch ladder. The annunciation is removed once the condition is resolved.

Alert Condition	Annunciation	Description
Up-elevator Trim Required	↑ TRIM UP ↑	The autopilot does not have the required elevator authority to reach the desired flight condition.
Down-elevator Trim Required	↓ TRIM DOWN ↓	

Status Alerts

The following messages are displayed in the G3X Touch Autopilot Status Box.

Alert Condition	Annunciation	Description
Autopilot Failure	<b>AP</b>	Autopilot inoperative
Manual Autopilot Disengagement	<b>AP</b>	Autopilot Disengaged
Yaw Damper Failure	<b>YD</b>	Yaw Damper inoperative
Yaw Damper Manual Disengagement	<b>YD</b>	Yaw Damper Disengaged
Flight Director and Autopilot Failure	<b>AFCS</b>	Flight Director and Autopilot inoperative
Autopilot Failure		Autopilot inoperative, Flight Director operative

AFCS System Alerts

## SPEED ALERTS

If the remote autopilot unit supports speed alerts and the airspeed limitations configured have been reached, the following messages can be displayed over the pitch ladder. The annunciation is removed once the condition is resolved.

Alert Condition	Annunciation	Description
High speed Protection	<b>MAX SPEED</b>	Autopilot unit will raise the nose to limit the aircraft's speed.
Low speed Protection	<b>MIN SPEED</b>	Autopilot unit will lower the nose to prevent the aircraft's speed from decreasing.

### Speed Alerts

## AFCS AURAL ALERT

Manual disengagement of the autopilot is indicated by a five-second flashing yellow 'AP' annunciation and an aural (bee-boop) alert. Cancel the aural alert by pressing and releasing the **AP/CWS** Button again (GSA 28 autopilot only)

## VERTICAL POWER FAULT INDICATIONS

Device Fault	Description
<b>OVER VOLTAGE</b>	Voltage too high (only appears for alternator devices).
<b>OVER CURRENT</b>	Device current too high.
<b>NO CURRENT</b>	Device not drawing current (possible open circuit).
<b>SHORT CIRCUIT</b>	Short circuit detected.
<b>RUNAWAY</b>	Flap or trim runaway condition detected.
<b>SWITCH DISABLED</b>	Flap or trim switch disabled.
<b>FAULT CODE XX</b>	XX indicates an internal VP-X fault code (consult Vertical Power for details).
<b>ERROR</b>	Unable to clear fault or other error occurred.

### Device Faults

## SECTION 11 APPENDICES

### APPENDIX A: DATA FIELD OPTIONS

#### DATA BAR FIELD OPTIONS

Data Bar Field	Definition
<b>BRG - Bearing to Waypoint</b>	The compass direction from the present position to the next waypoint.
<b>CABIN - Cabin Altitude</b>	Current pressure altitude of aircraft cabin (Requires a compatible CO detector)
<b>CLG - Climb Gradient</b>	Current climb gradient (climb rate divided by groundspeed) in percent.
<b>CLM - Climb Gradient (ALT/NM)</b>	Current climb gradient (climb rate divided by groundspeed) in altitude per nautical mile.
<b>CO -Carbon Monoxide (PPM)</b>	Displays current carbon monoxide level in parts per million. (Requires a compatible CO detector.)
<b>DA - Density Altitude</b>	Pressure Altitude adjusted for non-standard temperature.
<b>DIST - Distance to Waypoint</b>	The distance to the next waypoint in the Active Flight Plan.
<b>DISTD - Distance to Destination Waypoint</b>	The distance to the destination waypoint in the Active Flight Plan.
<b>DTK - Desired Track</b>	The desired course between the active "from" and "to" waypoints.
<b>ECO - Fuel Economy</b>	This value is calculated by dividing the current ground speed by the current fuel flow.
<b>EDR - Fuel Endurance</b>	This value is obtained by dividing the amount of fuel on board by the current fuel flow (endurance to empty - no reserve included).
<b>ESA - En Route Safe Altitude</b>	The recommended minimum altitude within ten miles left or right of the desired course on an active flight plan or direct-to.

## DATA BAR FIELD OPTIONS

Data Bar Field	Definition
<b>ETA - Estimated Time of Arrival</b>	The estimated time at which the aircraft should reach the next waypoint, based upon current ground speed and track.
<b>ETAD - Estimated Time of Arrival</b>	The estimated time at which the aircraft should reach the destination waypoint, based upon current ground speed and track.
<b>ETE - Estimated Time En Route</b>	The estimated time it takes to reach the next waypoint from the present position, based upon current ground speed.
<b>ETED - Estimated Time Enroute to Destination</b>	The estimated time it takes to reach the destination waypoint from the present position, based upon current ground speed.
<b>ETV - Estimated Time to VNAV</b>	The estimated time it takes to reach the VNAV waypoint from the present position, based upon current ground speed.
<b>FOD - Fuel Over Destination</b>	The estimated amount of fuel remaining when the aircraft reaches the destination waypoint. Calculated by multiplying fuel flow times estimated time enroute (ETED) and subtracting from fuel remaining (REM).
<b>FLT - Flight Time</b>	The total time in flight.
<b>FF - Fuel Flow</b>	The current fuel flow.
<b>G - G-Meter</b>	The amount of positive or negative G's.
<b>GR - Glide Ratio</b>	The ratio of horizontal distance (distance traveled over the ground) to vertical distance traveled (n:n:1).
<b>GS - Ground Speed</b>	The velocity that the aircraft is traveling relative to a ground position.
<b>ISA - ISA Temperature Deviation</b>	The difference between OAT and the standard atmospheric temperature at the current altitude.
<b>LCL - Time of Day (Local)</b>	The current time and date in 12-hour or 24-hour format.

**DATA BAR FIELD OPTIONS**

Data Bar Field	Definition
<b>MACH - Mach Number</b>	A unit of speed that measures the ratio of the speed of an airplane to the speed of sound in the same atmospheric conditions.
<b>MSA - Minimum Safe Altitude</b>	Uses Grid MORAs to determine a safe altitude within ten miles of the aircraft's present position.
<b>OAT - Outside Air Temperature</b>	The static air temperature outside the aircraft. This is the temperature measured by the OAT probe, with correction for ram temperature rise.
<b>RAT - Ram Air Temperature</b>	The temperature measured by the OAT probe, without correction for ram temperature rise.
<b>REM - Fuel Remaining</b>	The current fuel remaining (gal) adjusted for fuel burn and based on fuel flow.
<b>TRK - Ground Track</b>	Direction of aircraft movement relative to a ground position.
<b>USD - Fuel Used</b>	The quantity of fuel used (gal) based on fuel flow.
<b>UTC - Time</b>	The current time in Universal (UTC) time.
<b>VSR - Vertical Speed Required</b>	The vertical speed necessary to descend/climb from the current position and altitude to the previously selected VNAV position and altitude, based upon current ground speed.
<b>WPT - Next Waypoint</b>	The next waypoint in the flight plan or direct-to route.
<b>WX ALTIM</b>	The altimeter setting at the nearest METAR reporting station.
<b>WX WIND</b>	The surface wind at the nearest METAR reporting station.
<b>XTK - Crosstrack Error</b>	The distance the aircraft is from a desired course in either direction, left or right.

## INFO PAGE DATA FIELD OPTIONS

Info Page Data Field Option	Definition
<b>Accuracy (ACCURACY)</b>	The current accuracy of the GPS determined location.
<b>Altitude (ALTITUDE)</b>	The current altitude in geometric height above Mean Sea Level (MSL).
<b>Bearing (BRG)</b>	The compass direction from the present position to a destination waypoint.
<b>Cabin Altitude (CABIN ALT)</b>	Current pressure altitude of aircraft cabin (Requires a compatible CO detector)
<b>Climb Gradient (Percent) (CLIMB GRAD)</b>	Current climb gradient in (climb rate divided by groundspeed) in percent.
<b>Climb Gradient (ALT/NM) (CLIMB/NM)</b>	Current climb gradient (climb rate divided by groundspeed) in altitude per nautical mile.
<b>Course to Steer (CTS)</b>	The recommended direction to steer in order to reduce cross-track error and return to the course line.
<b>Crosstrack Error (XTK)</b>	The distance the aircraft is off a desired course in either direction, left or right.
<b>Density Altitude (DENSITY ALT)</b>	Pressure Altitude adjusted for non-standard temperature.
<b>Desired Track (DTK)</b>	The desired course between the active "from" and "to" waypoints.
<b>Distance (Destination) (DIST DEST)</b>	The distance to the destination waypoint in the Active Flight Plan.
<b>Distance (Next) (DIST NEXT)</b>	The distance to the next waypoint in the Active Flight Plan.
<b>En Route Safe Altitude (ESA)</b>	The recommended minimum altitude within ten miles left or right of the desired course on a active flight plan or direct-to.
<b>Flight Timer (FLT TIMER)</b>	Total time in-flight (HH:MM).
<b>Fuel Economy (ECONOMY)</b>	Current Mile Per Gallon (MPG), based upon ground speed and fuel flow.



**INFO PAGE DATA FIELD OPTIONS**

Info Page Data Field Option	Definition
<b>Fuel Endurance (ENDURANCE)</b>	This value is obtained by dividing the amount of fuel on board by the current fuel flow (endurance to empty - no reserve included).
<b>Fuel Flow (FUEL FLOW)</b>	The current fuel flow.
<b>Fuel Remaining (FUEL REM)</b>	The current fuel remaining (gal) adjusted for fuel burn and based on fuel flow.
<b>Fuel Timer (FUEL TIMER)</b>	Elapsed time since the Fuel Tank Reminder Alarm was last issued (HH:MM).
<b>Fuel Used (FUEL USED)</b>	The quantity of fuel used (gal) based on fuel flow.
<b>Fuel Over Destination (FOD)</b>	The estimated amount of fuel remaining when the aircraft reaches the destination waypoint. This value is calculated by multiplying fuel flow times estimated time enroute (ETED) and subtracting from fuel remaining (REM).
<b>Glide Ratio (G/R)</b>	The ratio of horizontal distance (distance traveled over the ground) to vertical distance traveled (nn.n:1).
<b>Ground Speed (GS)</b>	The velocity that the aircraft is traveling relative to a ground position.
<b>Ground Track (TRK)</b>	The direction of aircraft movement relative to a ground position.
<b>ISA Temperature Deviation (ISA)</b>	The difference between OAT and the standard atmospheric temperature at the current altitude.
<b>Mach Number (MACH)</b>	A unit of speed that measures the ratio of the speed of an airplane to the speed of sound in the same atmospheric conditions.
<b>Minimum Safe Altitude (MSA)</b>	Uses Grid MORAs to determine a safe altitude within ten miles of the aircraft's present position.
<b>Next Waypoint (NEXT WPT)</b>	The next waypoint in the flight plan or direct-to route.

- System Overview
- Flight Instruments
- EIS
- CNS Interface
- GPS Navigation
- Flight Planning
- Hazard Avoidance
- Additional Features
- AFCS
- Annun/Alerts
- Appendix
- Index

## INFO PAGE DATA FIELD OPTIONS

Info Page Data Field Option	Definition
<b>Outside Air Temperature (OAT)</b>	The static air temperature outside the aircraft. This is the temperature measured by the OAT probe, with correction for ram temperature rise.
<b>Ram Air Temperature (RAT)</b>	The temperature measured by the OAT probe, without correction for ram temperature rise.
<b>Sunrise (SUNRISE)</b>	The time at which the sun rises on this day (current location).
<b>Sunset (SUNSET)</b>	The time at which the sun sets on this day (current location).
<b>SXM (Now Playing) (SXM)</b>	The selection now playing on SiriusXM Radio.
<b>Time En Route (Destination) (ETE DEST)</b>	The estimated time it takes to reach the destination waypoint from the present position, based upon current ground speed.
<b>Time En Route (Next) (ETE NEXT)</b>	The estimated time it takes to reach the next waypoint from the present position, based upon current ground speed.
<b>Time of Arrival (Destination) (ETA DEST)</b>	The estimated time at which the aircraft should reach the destination waypoint, based upon current speed and track.
<b>Time of Arrival (Next) (ETA NEXT)</b>	The estimated time at which the aircraft should reach the next waypoint, based upon current speed and track.
<b>Time to VNAV (VNAV TIME)</b>	The estimated time it takes to reach the VNAV waypoint from the present position, based upon current ground speed.
<b>Time (Local) (TIME)</b>	The current time and date in 12-hour or 24-hour format.
<b>Time (UTC) (TIME)</b>	The current time and date in Universal (UTC) time.
<b>Vertical Speed (VS)</b>	The rate of climb or descent (GPS-derived).

## INFO PAGE DATA FIELD OPTIONS

Info Page Data Field Option	Definition
<b>Vertical Speed Required (VSR)</b>	The vertical speed necessary to descend/climb from the current position and altitude to the previously selected VNAV position and altitude, based upon current ground speed.
<b>Wx (Altimeter) (WX ALTIM)</b>	The altimeter setting at the nearest METAR reporting station.
<b>Wx (Dew Point) (WX DEW PT)</b>	The dew point at the nearest weather reporting station.
<b>Wx (Rel. Humidity) (WX HUMIDITY)</b>	The relative humidity at the nearest weather reporting station.
<b>Wx (Temperature) (WX TEMP)</b>	The temperature at the nearest weather reporting station.
<b>Wx (Wind) (WX WIND)</b>	The surface wind at the nearest METAR reporting station.

System Overview

Flight Instruments

EIS

CNS Interface

GPS Navigation

Flight Planning

Hazard Avoidance

Additional Features

AFCS

Annun/Alerts

Appendix

Index

- System Overview
- Flight Instruments
- EIS
- CNS Interface
- GPS Navigation
- Flight Planning
- Hazard Avoidance
- Additional Features
- AFCS
- Annun/Alerts
- Appendix**
- Index

Blank Page

## APPENDIX B: UTILITIES



**NOTE:** In a multi-display system, the Flight Log page is available on the PFD1 display only.

### FLIGHT LOG

The Flight Log shows a list of any recorded flights, including date, route of flight, and flight time. The G3X Touch saves up to 50 recorded flights. Entries on this list are automatically created for each flight.

With EIS items configured, recording begins when the engine hours timer or airframe total hours is running. This allows recording of time spent on ground before takeoff and after landing while the engine is running.

With no EIS items configured, recording begins when the aircraft reaches 250 feet of altitude. When the aircraft's groundspeed drops below 30 knots, the flight entry is saved and a new entry is recorded when departing the airport. A touch-and-go or brief stop of less than 10 minutes appends to the current flight record, rather than starting a new entry.

### VIEWING THE FLIGHT LOG

Select any listed entry in the log to view additional information, including a map displaying the actual path flown.

#### Viewing details for a flight:

- 1) From the split-screen or full-screen MFD, press the **MENU** Key twice to display the Main Menu. (The Flight Log option is not available from the full-screen PFD Main Menu).
- 2) Touch the **Flight Log** Button. The Flight Log Page is displayed. (Hours and minutes can be displayed by pressing the **MENU** Key and touching the **Show Hours and Minutes** Button).
- 3) Touch the desired flight log in the list. The Flight Log Map Window is displayed. Date, start/stop times, route, hours, distance, and actual flight path are displayed (full-screen).
- 4) Press the **Back** Key, or touch the Flight Log Page beside the Flight Log Map Window, to return to the Flight Log Page.

- System Overview
- Flight Instruments
- EIS
- CNS Interface
- GPS Navigation
- Flight Planning
- Hazard Avoidance
- Additional Features
- AFCs
- Annun/Alerts
- Appendix
- Index

Flight Log		
26-MAR-14	KOJC-____	0.2 Hours
26-MAR-14	KOJC-KMCI	4.6 Hours

Flight Log List (Split-Screen)

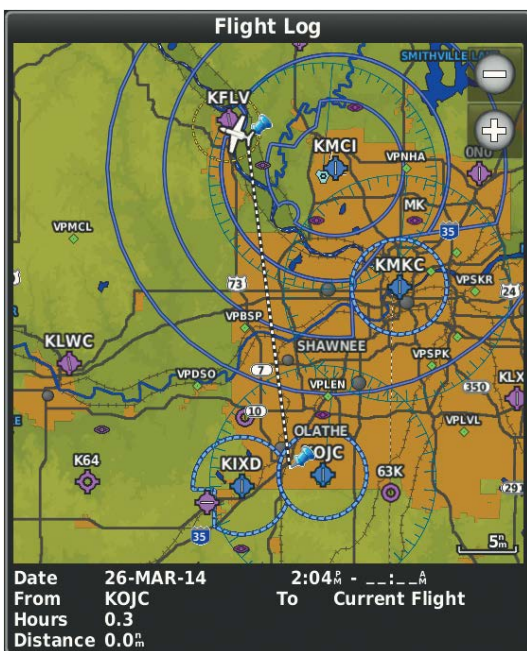

Flight Log Map (Split-Screen)

## DELETING FLIGHT LOGS

You can delete a single flight log or delete all flight logs from the Flight Log.

### Deleting a single flight log:

- 1) From the split-screen and/or full-screen MFD, press the **MENU** Key twice to display the Main Menu. (The 'Flight Log' option is not available from the full-screen PFD Main Menu).
- 2) Touch the **Flight Log** Button. The Flight Log Page is displayed.
- 3) Touch the desired flight log in the list. The Flight Log Map Window is displayed.
- 4) Press the **MENU** Key to display the flight log map menu.
- 5) Touch the **Delete Flight** Button.
- 6) Touch the **Yes** Button to delete the flight log, or touch the **No** Button to cancel the deletion.

### Deleting all flight records:

- 1) From the split-screen and/or full-screen MFD, press the **MENU** Key twice to display the Main Menu. (The 'Flight Log' option is not available from the full-screen PFD Main Menu).
- 2) Touch the **Flight Log** Button. The Flight Log Page is displayed.
- 3) Press the **MENU** Key to display the flight log menu.
- 4) Touch the **Delete All** Button.
- 5) Touch the **Yes** Button to delete the flight log, or touch the **No** Button to cancel the deletion.

## TRACK LOG

The G3X Touch draws an electronic breadcrumb trail or “track log” on the Map Page. The track log contains points along its path, including time and location for each point.

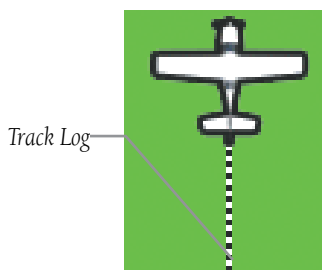

Track Log (Map Page)

The track log starts recording as soon as the G3X Touch gets a location fix. For the best results, clear the track log before each flight. When the track log is full, new track points overwrite the oldest track points (if set to ‘Wrap’ in the Track Log Settings).

The percentage of memory used by the current track log appears at the top of the Track Log Window. After the track log is cleared, it shows zero percent. When the screen reaches 100%, the most recent track points start to overwrite the least recent track points (if ‘Wrap’ is selected in the Record Mode Field). To avoid losing track points, save the track log when it approaches the 99% mark.

The Save feature allows storage of up to 15 track logs.

### Displaying/removing the track log on the Map Page:

- 1) From the Map Page, press the **MENU** Key. The Map Options Window is displayed.
- 2) Touch the **Set Up Map...** Button to display the Map Setup Page.
- 3) Touch the **Line** Tab to display the track log setup options.
- 4) Touch the Track Log Show/Hide Button.
- 5) Touch the **Show** Button to display the track log. Touch the **Hide** Button to remove the track log.
- 6) Press the **BACK** Key to return to the Map Page.





Map Page Menu



Map Setup Page - Line Tab

## Changing track log settings:

- 1) From the Map Page, press the **MENU** Key. The Map Page Menu is displayed. (The 'Track Log' option is not available from the full-screen PFD Main Menu).
  - 2) Touch the **Set Up Map...** Button to display the Map Setup Page.
  - 3) Touch the **Line** Tab to display the track log setup options.
  - 4) Touch the button associated with the desired setting.
  - 5) Touch the button to select the desired option. Repeat step for each setting to be changed.
  - 6) Press the **BACK** Key to return to the Map Page.
- Track Record Mode - 'Wrap' records over the oldest tracks when the track log reaches 100%. 'Fill' records a track log until the track log is full (100%).
  - Track Interval - 'Distance' records track points after a specified distance has been traveled. 'Time' creates track points after a specified time has elapsed.
  - Track Color - Select a color for the track when it appears on the map.

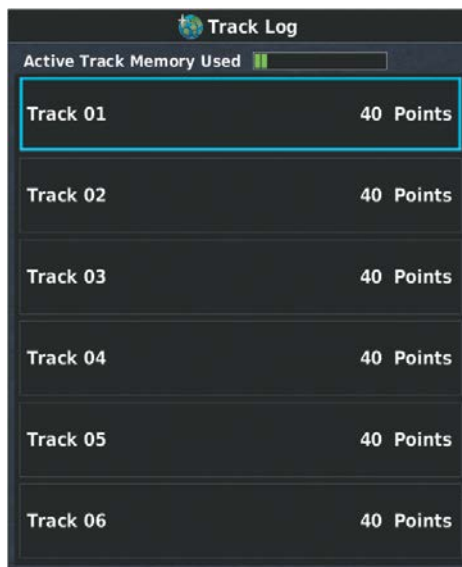

Track Log Window (Split-Screen)

### Deleting a single saved track log:

- 1) From the split-screen and/or full-screen MFD, press the **MENU** Key twice to display the Main Menu. (The 'Flight Log' option is not available from the full-screen PFD Main Menu).
- 2) Touch the **Track Log** Button. The Track Log Page is displayed.
- 3) Touch the desired track log in the list. The Saved Track Window is displayed.
- 4) Press the **MENU** Key to display the saved track menu.
- 5) Touch the **Delete Saved Track** Button.
- 6) Touch the **Yes** Button to delete the saved track, or touch the **No** Button to cancel the deletion.

### Deleting all saved track logs:

- 1) From the split-screen and/or full-screen MFD, press the **MENU** Key twice to display the Main Menu. (The 'Flight Log' option is not available from the full-screen PFD Main Menu).
- 2) Touch the **Track Log** Button. The Track Log Page is displayed.
- 3) Press the **MENU** Key to display the track log menu.
- 4) Touch the **Delete All Saved Tracks** Button.
- 5) Touch the **Yes** Button to delete all saved tracks, or touch the **No** Button to cancel the deletion.

### Saving a track log:

- 1) From the split-screen or full-screen MFD, press the **MENU** Key twice. (The 'Track Log' option is not available from the full-screen PFD Main Menu).
- 2) Touch the **Track Log** Button. The Track Log Page is displayed.
- 3) Press the **MENU** Key to display the track log menu.
- 4) Touch the **Save Active Track** Button.
- 5) Touch the track selection button to choose what will be saved.

**Entire Active Track, Past 24 Hours, Past 7 Days, Selected Flight, or Selected Dates**

- 6) If Selected Flight or Selected Dates are chosen, select the flight or dates using the buttons.
- 7) Touch the **Enter** Button to save the track, or touch the **Cancel** Button to cancel the save.

### Editing a track log:

- 1) From the split-screen and/or full-screen MFD, press the **MENU** Key twice to display the Main Menu. (The 'Flight Log' option is not available from the full-screen PFD Main Menu).
- 2) Touch the **Track Log** Button. The Track Log Page is displayed.
- 3) Touch the desired track log in the list. The Saved Track Window is displayed.
- 4) Touch the Name Button to display the keypad. Use the keypad to select the name, then touch the **Enter** Button. Touch the **Cancel** Button to exit without changing the name.
- 5) Touch the Color Button to display a list of color choices. Touch the button for the desired color
- 6) Touch the **Show on Map** Button to show the track on the map.

## TRACK VECTOR

The G3X Touch draws an electronic "Track Vector" on the Map Page. The Track Vector can be set to time or distance.



Track Vector (Map Page)

### Changing the Track Vector settings on the Map Page:

- 1) From the Map Page, press the **MENU** Key. The Map Page Menu is displayed.
- 2) Touch the **Set Up Map...** Button to display the Map Setup Page.
- 3) Touch the **Line** Tab to display the Track Vector setup options.

- 4) Touch the Track Vector Off/Distance/Time Button.
- 5) Touch the **Off** Button to turn the Track Vector On or Off.

**Or:**

Touch the **Distance** Button to define the length of the Track Vector by distance. Touch the distance value button to bring up the keypad to select the distance, and touch the **Enter** Button.

**Or:**

Touch the **Time** Button to define the length of the Track Vector by time. Touch the **+** Button or **-** Button to select the time.

- 6) Press the **BACK** Key to return to the Map Page.

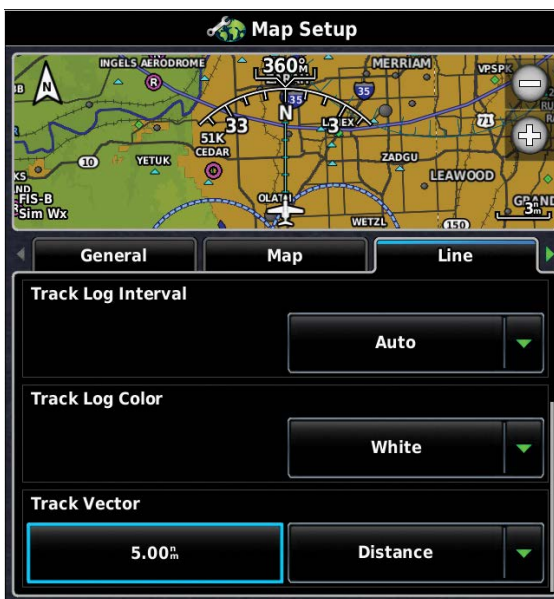

Track Vector Settings (Map Setup Page)

## WEIGHT & BALANCE

System Overview

Flight Instruments

EIS

CNS Interface

GPS Navigation

Flight Planning

Hazard Avoidance

Additional Features

AFCs

Annun/Alerts

Appendix

Index



**NOTE:** Refer to the G3X Touch Installation Manual for information on configuring the Weight & Balance Page.

Weight & Balance may be used during pre-flight preparations to verify the weight and balance conditions of the aircraft. By entering the weight values on this page, the G3X Touch can calculate the total weight, moment, and center of gravity (CG).



**NOTE:** This information is only for flight planning purposes. Consult the aircraft's pilot operating handbook for the official weight and balance data.

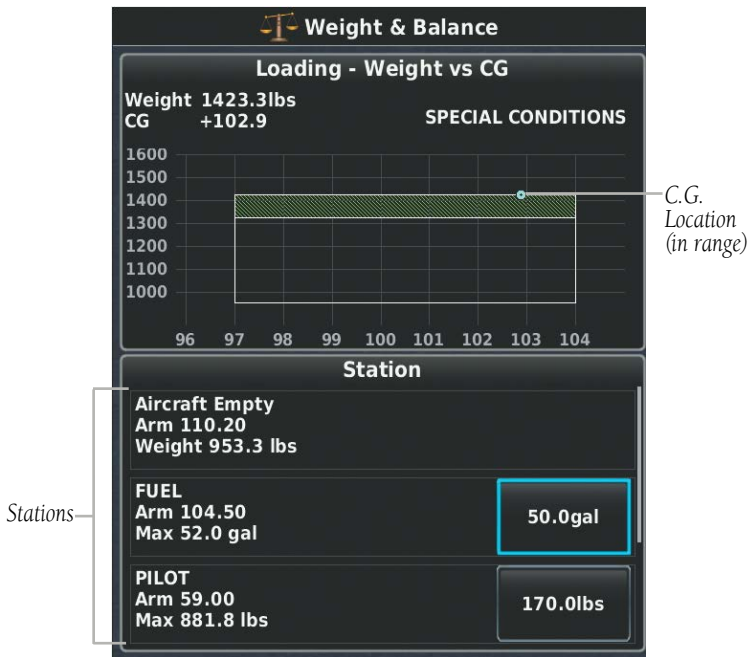

Weight and Balance Page (C.G. in Range)

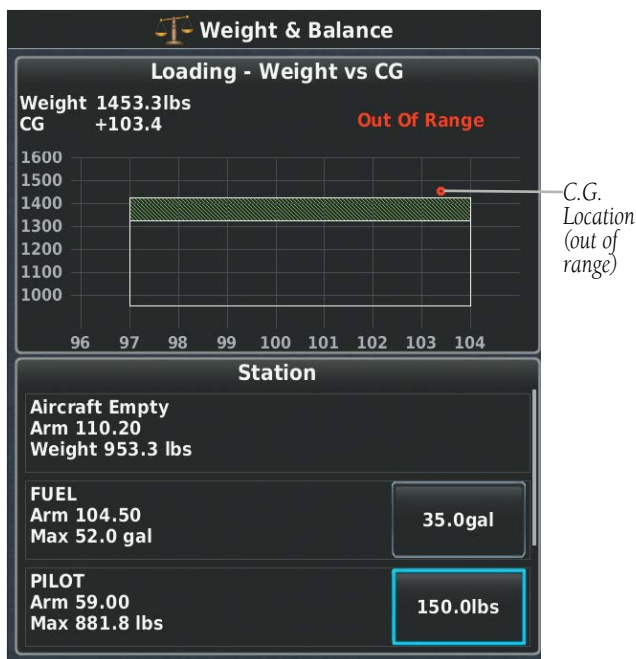

Weight and Balance Page (C.G. Out of Range)

## Performing weight and balance calculations:

- 1) Press the **MENU** Key twice to display the Main Menu.
- 2) Touch the **Weight & Balance** Button. The Weight & Balance Page is displayed. (Kilograms can be displayed by pressing the **MENU** Key and touching the **Show Kilograms** Button)
- 3) Touch the desired station button. The FUEL keypad is displayed.
- 4) Use the keypad to select the desired weight, then touch the **Enter** Button. The calculated moment, weight, and CG figures are calculated and appear at the top of the page. Touch the **Cancel** Button to exit without changing the weight.
- 5) Repeat Steps 3 and 4 to enter the weights for each station.

## Resetting weight & balance page:

- 1) From the Weight & Balance page, press the **MENU** Key.
- 2) Touch the **Empty Aircraft** Button.
- 3) Touch the **Yes** Button to empty the aircraft, or touch the **No** Button to cancel the action.



Weight &amp; Balance Page Menu

If the Loading Limit for a particular station is exceeded, the station data will turn yellow.



Loading Limit Exceeded

## PROXIMITY WAYPOINTS

The Proximity Waypoints Page allows the pilot to define an alarm circle around a waypoint location.

### Creating proximity waypoints:

- 1) Press the **MENU** Key twice to open the Main Menu.
- 2) Touch the **User Waypoints** Button. The User Waypoints Page is displayed.
- 3) Touch the **PROXIMITY** Tab. The Proximity Waypoints List is displayed.
- 4) Press the **MENU** Key. The Proximity Waypoint Menu is displayed.
- 5) Touch the **New Proximity Waypoint** Button.
- 6) Touch the **Use Map** Button or the **Use Identifier** Button.
- 7) If using an identifier, select the desired waypoint using the Waypoint Identifier Window. Touch the **Enter** Key to create the proximity waypoint.



Touch the **Cancel** Key to exit without creating a proximity waypoint.

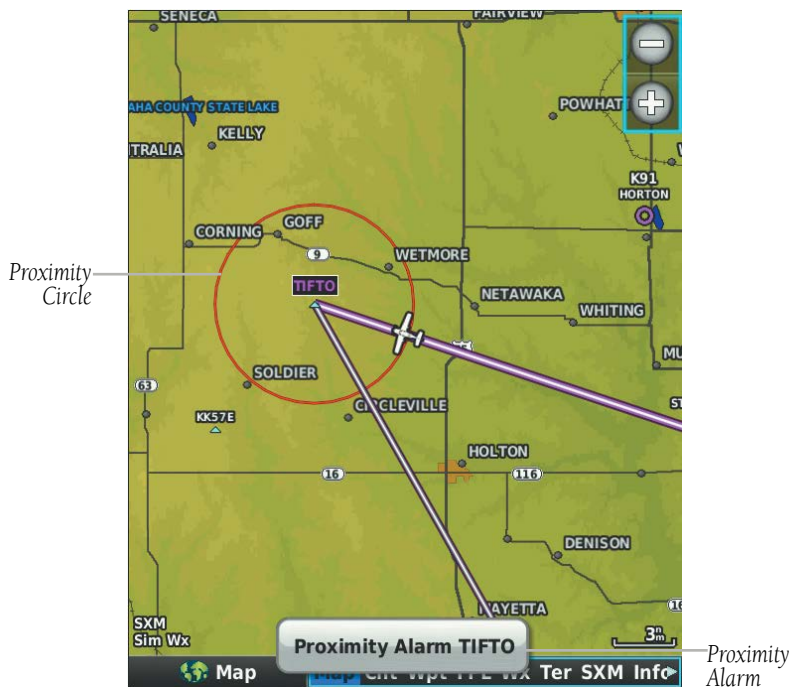

Proximity Waypoint Alarm

### Enabling/disabling proximity waypoint alarms:

- 1) Press the **MENU** Key twice to open the Main Menu.
- 2) Touch the **User Waypoints** Button. The User Waypoints Page is displayed.
- 3) Touch the **PROXIMITY** Tab. The Proximity Waypoints List is displayed.
- 4) Press the **MENU** Key. The Proximity Waypoint Menu is displayed.
- 5) Touch the **Enable Proximity Alarms** Button, or the **Disable Proximity Alarms** Button, to enable/disable proximity alarms.

**Or:**

- 1) Press the **MENU** Key twice to open the Main Menu.
- 2) Touch the **Setup** Button. The Setup Page is displayed.
- 3) Touch the **Alarms** Button. The Alarms Setup Page is displayed.

- 4) Touch the Proximity Waypoint **On** Button or **Off** Button, to enable/disable proximity alarms.

**Or:**

- 1) From the Map Page, press the **MENU** Key. The Map Page Menu is displayed.
- 2) Touch the **Set Up Map...** Button to display the Map Setup Page.
- 3) Scroll the horizontal tabs, if necessary, and touch the **Point** Tab to display the Track Vector setup options.
- 4) Touch the Proximity Circle Off/Distance Button to display the choices.
- 5) Touch the **Off** Button to disable proximity circles, press any other button to enable proximity circles with the desired radius.

### Deleting a single proximity waypoint:

- 1) Press the **MENU** Key twice to open the Main Menu.
- 2) Touch the **User Waypoints** Button. The User Waypoints Page is displayed.
- 3) Touch the **PROXIMITY** Tab. The Proximity Waypoints List is displayed.
- 4) Touch the desired proximity waypoint in the list. The Proximity Waypoint Menu is displayed.
- 5) Touch the **Delete Proximity Waypoint** Button.
- 6) Touch the **Yes** Button to delete the proximity waypoint, or touch the **No** Button to cancel the deletion.

### Deleting all proximity waypoints:

- 1) Press the **MENU** Key twice to open the Main Menu.
- 2) Touch the **User Waypoints** Button. The User Waypoints Page is displayed.
- 3) Touch the **PROXIMITY** Tab. The Proximity Waypoints List is displayed.
- 4) Press the **MENU** Key. The Proximity Waypoint Menu is displayed.
- 5) Touch the **Delete All** Button.
- 6) Touch the **Yes** Button to delete all proximity waypoints, or touch the **No** Button to cancel the deletion.

## APPENDIX C: SD CARD USE AND DATABASES



**NOTE:** It is recommended to maintain three SD cards for the G3X system. One SD card should be used exclusively for loading software, another SD card should be used exclusively for loading databases, and a third card should be used exclusively for flight purposes.



**NOTE:** When flying the G3X system, any SD card(s) used in the GDU(s) should contain only files which are necessary for the flight of the aircraft. Non-essential files may have a negative effect on display performance.

The G3X Touch uses an SD Card for software updates, database updates, MapSource® data, checklist files, Chartview, Flight Data Logging, exporting Track Logs/User Waypoints, importing/exporting Flight Plans and user-downloaded vehicles. Garmin recommends using a 8 GB SanDisk or Toshiba SD Card.

MapSource detailed maps are available from your local Garmin dealer. Refer to the Garmin website ([www.garmin.com](http://www.garmin.com)) for instructions on downloading software updates. Refer to the latest revision of the G3X Touch Installation Manual for software update instructions.

### INSTALLING AND REMOVING SD CARDS



**NOTE:** SD Cards are not waterproof. They should not be exposed to moisture or excessive static charges, and should be stored in the case supplied with the card.



SD Card Slot - GDU 46X (10.6 inch)

### Installing an SD Card:

- 1) Insert the card into the slot at the lower, center, front of the bezel. Be sure the SD Card contacts are facing downwards.
- 2) Firmly push the card into the unit. It is not necessary to force the card.

If you insert an SD Card and get a card format not recognized message, try removing the card and reinserting it. If the card is still not recognized, contact Garmin Product Support or your Garmin dealer.

### Removing an SD Card:

- 1) Push the card into the unit until it stops.
- 2) Release the card. The card should eject for easy removal.
- 3) With the card ejected, pull the card out of the slot.

## G3X TOUCH DATABASES

The following databases are available with the G3X Touch depending on the unit (Americas, Atlantic, or Pacific). See the Additional Feature section for information on Airport Directories, FliteCharts®, and SafeTaxi®. See the Hazard Avoidance section for information on Obstacles and Terrain.

Database	Americas	Atlantic	Pacific
Worldwide Basemap	+	+	+
Airport Directory (AOPA or AC-U-KWIK)	+	+	+
Navigation Database (Jeppesen® or AeroNav (US only))	+	+	+
FliteCharts®	+	+	
SafeTaxi®	+	+	
Obstacle	+	+	
Terrain	+	+	+
VFR Sectionals	+	+	
IFR Charts	+	+	

**Available Databases**

### BASEMAP

The basemap database contains data for the topography and land features, such as river, lakes, and towns. It is updated only periodically, with no set schedule. There is no expiration date.

### AIRPORT DIRECTORY DATABASES

The AOPA Airport Directory provides data on airports and heliports throughout the U.S. and it is updated on a 56-day cycle. Detailed information for over 5,300 U.S. airports, along with the names and phone numbers of thousands of FBOs can be viewed. This service allows the pilot to plan an overnight, choose fuel stops, find ground transportation, etc.

Optional airport directory databases such as AC-U-KWIK are also supported. AC-U-KWIK provides complete listings of FBOs, charter companies, fuel suppliers, ground transportation, maintenance and catering services at public airports across the world.

## NAVIGATION DATABASE

The G3X Touch includes an internal navigation database that provides location and facility information for thousands of airports, VORs, NDBs, and more. Updates to the navigation database are available every 28 days online ([www.fly.garmin.com](http://www.fly.garmin.com)). There are two navigation database products available: the Jeppesen Navigation Database, which is sourced by Jeppesen, and the US VFR Navigation Database sourced by AeroNav Products, a division of the FAA.



**NOTE:** *Although the Jeppesen Navigation Database and the US VFR Navigation Database contain much of the same information, pilots may notice differences in behavior, nearest list functionality, direct-to functionality, and map page display due to data content variations. The US VFR Navigation Database, by AeroNav Products, does not contain any approach data.*

- \*Airport—identifier, facility name, city/state/country, latitude/longitude, field elevation, available fuel types, runway designations and layout, runway surface, runway length, runway width, runway lighting, communication frequencies, and published approaches (Jeppesen Navigation Database only).
- Weather—frequencies associated with an airport (ASOS, ATIS, and AWOS).
- \*VORs—identifier, facility name, city/state/country, location (latitude/longitude), frequency, service volume (high, low, terminal), and type (such as VOR-DME, TACAN, and VORTAC).
- \*NDBs—identifier, facility name, city/state/country, location (latitude/longitude), and frequency.
- Intersections—identifier, nearest VOR, radial and distance from nearest VOR, location (latitude/longitude), and region/country.
- ARTCC—Air Route Traffic Control Centers.
- Airspace—boundaries (Class B, Class C, Control Zones, SUAs, and MOAs), controlling agency, and vertical boundaries.

- FSS—Flight Service Stations.

\* Symbology used for NDBs, VORs, and airports is consistent with those used on a sectional chart.



---

**NOTE:** After performing a navigation database update, verify all flight plan(s) (routes) are current. If there is an obsolete aviation point in a saved route, the route is locked and unusable. A new route with current navigation database points will need to be created.

---

## FLITECHARTS

The FliteCharts database contains procedure charts for the United States only. This database is updated on a 28-day cycle.

## CHARTVIEW

ChartView database is revised every 14 days. Charts are still viewable during a period that extends from the cycle expiration date to the disables date. ChartView is disabled 70 days after the expiration date and is no longer available for viewing. The ChartView database is always on the SD Card and is not copied to the GDU's internal memory.

## SAFETAXI

The SafeTaxi database contains detailed airport diagrams for selected airports. These diagrams aid in following ground control instructions by accurately displaying the aircraft position on the map in relation to taxiways, ramps, runways, terminals, and services. This database is updated on a 56-day cycle.

## OBSTACLE

The obstacle database contains data for obstacles, such as towers, that pose a potential hazard to aircraft. Obstacles 200 feet and higher are included in the obstacle database. It is very important to note that not all obstacles are necessarily charted and therefore may not be contained in the obstacle database. This database is updated on a 56-day cycle.

## TERRAIN



**NOTE:** The data contained in the terrain and obstacle databases comes from government agencies. Garmin accurately processes and cross-validates the data, but cannot guarantee the accuracy and completeness of the data.

The terrain database is updated periodically and has no expiration date.

## UPDATING G3X TOUCH DATABASES



**NOTE:** The databases are stored internally on each GDU. When updating a system with multiple GDUs, each GDU will need to be updated individually using the same SD card.

The G3X Touch database updates can be obtained by visiting the 'flyGarmin' website ([www.fly.garmin.com](http://www.fly.garmin.com)). The 'flyGarmin' website requires the unit's System ID to update databases. This allows the databases to be encrypted with the unit's unique System ID when copied to the SD Card.

### Obtaining the System ID:

- 1) Press the **MENU** Key twice to access the Main Menu.
- 2) Touch the **Tools** Button.
- 3) Touch the **Database Information** Button. The Database Information Page is displayed. Scroll down if necessary to see the System ID.





## Database Information

**US Obstacles Cycle 11B5 Effective 25-AUG-2011 to 20-OCT-2011** © 2011 Garmin Ltd. or its subsidiaries

**Worldwide-9 Terrain Cycle 11T1** © 2011 Garmin Ltd. or its subsidiaries

**AOPA Directory Data Cycle 10D5 Published 13-SEP-2010**  
© 2010 Aircraft Owners and Pilots Association

**US IFR/VFR Charts Cycle 1109 Effective 25-AUG-2011** © 2011 Garmin Ltd. or its subsidiaries

**Worldwide Aviation Basemap v2.00** © Garmin Ltd. or its subsidiaries Mda Federal, Inc 2008

Other System Information

System sbw WS Mar 25 2014 12:09:09 2.22b  
© 2014 Garmin Ltd. or its subsidiaries

System ID: 6000200000001

Unit ID: 0000000001

Boot Block Software Version 0.00

X-Loader Software Version 0.00

Splash Screen Missing

System ID

Database Information Page

System Overview

Flight Instruments

EIS

CNS Interface

GPS Navigation

Flight Planning

Hazard Avoidance

Additional Features

AFCS

Annun/Alerts

Appendix

Index

## Updating G3X Touch Databases:

Equipment required to perform the update:

- Windows-compatible PC computer (Windows 2000 or XP recommended)
  - Verbatim 96504 SD Card Reader or equivalent
  - Updated database obtained from the flyGarmin website
  - SD Card, 8 GB recommended (Garmin recommends SanDisk or Toshiba SD cards)
- 1) After the data has been copied to the SD Card, insert the SD card in the SD card slot of the display.
  - 2) Power on the display. The Update Databases Page is displayed. A green checkmark indicates that the database installed on the G3X Touch is up to date. An empty checkbox indicates that the database on the SD card is more current and should be installed.

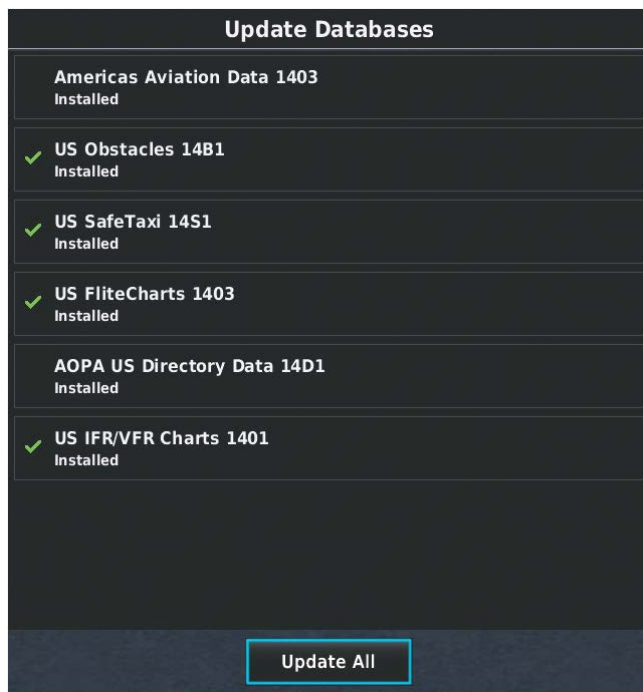

Update Databases Page

- 3) Touch the **Update All** Button. The database status is updated.

**Or:**

Touch a single database, and press the **Update** Button. The selected database status is updated.



#### Update Databases Page (Database Status Updated)

- 4) Press the **BACK** Key. Once the database(s) have been successfully updated, the SD Card can be removed from the unit.
- 5) Repeat steps 1-4 for the remaining GDUs if applicable.

#### Reloading G3X Touch Databases:

- 1) Insert the SD card containing the data to be reloaded into the SD card slot of the display.
- 2) Power on the display.
- 3) Press the **MENU** Key twice to open the Main Menu.
- 4) Touch **Tools**.
- 5) Touch Database Information.
- 6) Press the **MENU** Key.
- 7) Touch **Update Databases**. The database status is updated.

## IMPORTING/EXPORTING FLIGHT PLANS TO/FROM THE SD CARD

### Importing a flight plan:

- 1) With a flight plan saved to the SD Card, press the **MENU** Key twice to open the Main Menu.
- 2) Touch the **Flight Plan List** Button. The Flight Plan List Page is displayed.
- 3) Press the **MENU** Key. The Flight Plan List Menu is displayed.
- 4) Touch the **Import Flight Plans** Button. The Import Flight Plan Page is displayed.
- 5) Touch the flight plan to be imported. The flight plan is imported. Touch the **Enter** Button to complete the action.

### Exporting a flight plan:

- 1) With an SD Card inserted, press the **MENU** Key twice to open the Main Menu.
- 2) Touch the **Flight Plan List** Button. The Flight Plan List Page is displayed.
- 3) Touch the flight plan to be exported (highlighted with cyan box).
- 4) Press the **MENU** Key. The Flight Plan List Menu is displayed.
- 5) Touch the **Export Flight Plan** Button. The flight plan is exported. Touch the **Enter** Button to complete the action.

### Renaming a flight plan:

- 1) Press the **MENU** Key twice to open the Main Menu.
- 2) Touch the **Flight Plan List** Button. The Flight Plan List Page is displayed.
- 3) Touch the flight plan to be renamed (highlighted with cyan box).
- 4) Press the **MENU** Key. The Flight Plan List Menu is displayed.
- 5) Touch the **Rename Flight Plan** Button. The Flight Plan Name Window is displayed.
- 6) Use the keypad to select the name. Touch the **Enter** Button to complete the action. Touch the **Cancel** Button to exit the action without any change.

## FLIGHT DATA LOGGING

The G3X Touch also has the ability to log flight data. Refer to the Additional Features section for more information.

# APPENDIX D: MAP DATUM AND LOCATION FORMATS

## MAP DATUMS

A datum is a mathematical model of the Earth that approximates the shape of the Earth and enables calculations to be carried out in a consistent and accurate manner. The datum is physically represented by a framework of ground monuments (such as trig. stations) whose locations have been accurately measured and calculated on this reference surface. Lines of latitude and longitude on a chart are referenced to a specific map datum. Every chart has a map datum reference and the G3X Touch can be set to match most of those commonly used.

## LOCATION FORMATS

Your current location can be viewed on the GPS in the form of coordinates. Since different charts use different location formats, Garmin GPS units allow you to choose the correct coordinate system for the type of chart you are using. The most common format is latitude and longitude, which is used by all Garmin units. You can change the location format to use with other coordinate systems.

Map Datum and Location Format selection can be performed on the Position Setup Page.

### Changing position settings:

- 1) Press the **MENU** Key twice to display the Main Menu.
- 2) Touch the **Setup** Button. The Setup Page is displayed.
- 3) Touch the **Position** Button. The Position Setup Page is displayed.
- 4) Touch the Location Format button. The Location Format choices are displayed. Touch the button with the desired format.
- 5) Touch the Map Datum button. The Map Datum choices are displayed. Touch the button with the desired format.
- 6) Touch the Heading button. The Heading choices are displayed. Touch the button with the desired format.
- 7) Press the **MENU** Key to display the Position Menu. Touch the **Restore Defaults** Button to restore the default settings for all the position items.

- System Overview
- Flight Instruments
- EIS
- CNS Interface
- GPS Navigation
- Flight Planning
- Hazard Avoidance
- Additional Features
- AFCS
- Annun/Alerts
- Appendix**
- Index

Blank Page

## APPENDIX E: GENERAL TIS-A INFORMATION



**NOTE:** Aircraft without an operational transponder are invisible to TIS-A.



**WARNING:** Do not rely solely upon the display of traffic information for collision avoidance maneuvering. The traffic display does not provide collision avoidance resolution advisories and does not, under any circumstances or conditions, relieve the pilot's responsibility to see and avoid other aircraft.



**WARNING:** Do not rely solely upon the display of traffic information to accurately depict all of the traffic within range of the aircraft. Due to lack of equipment, poor signal reception, and/or inaccurate information from aircraft or ground stations, traffic may be present that is not represented on the display.

The Traffic Information Service (TIS-A) provides traffic advisory information to non-TAS/TCAS-equipped aircraft. TIS-A is a ground-based service providing the relative locations of all ATCRBS (Air Traffic Control Radar Beacon System) Mode-A and Mode-C transponder equipped aircraft within a specified service volume. The TIS-A ground sensor uses real-time track reports to generate traffic notification. The G3X Touch displays TIS-A traffic information on the Map Page. Surveillance data includes all transponder-equipped aircraft within the coverage volume. The G3X Touch displays up to eight traffic targets within a 7.5-nm radius, from 3,000 feet below, to 3,500 feet above the requesting aircraft.

### TIS-A VS. TAS/TCAS

The main difference between the Traffic Information System (TIS-A) and Traffic Advisory (TAS) or Traffic Collision Avoidance Systems (TCAS) is the source of surveillance data. TAS/TCAS uses an airborne interrogator with a half-second update rate, while TIS-A utilizes the terminal Mode-S ground interrogator and accompanying data link to provide a five-second update rate. TIS-A and TAS/TCAS have similar ranges.

## TIS-A LIMITATIONS

TIS-A relies on surveillance of the Mode-S radar system, which is a “secondary surveillance” radar system similar to that used by ATCRBS. Many limitations are inherent in secondary radar surveillance. Information provided by TIS-A is neither better nor more accurate than the information used by ATC. TIS-A is intended only to assist in visual acquisition of other aircraft in visual meteorological conditions (VMC). While TIS-A is a useful aid for visual traffic avoidance, system limitations must be considered to ensure proper use. No recommended avoidance maneuvers are given, nor authorized, as a direct result of a TIS-A intruder display or TIS-A advisory.

- TIS-A operation may be intermittent during turns or other maneuvering.
- TIS-A is dependent on two-way, line-of-sight communications between the aircraft and the Mode-S radar antenna. Whenever the structure of the aircraft comes between the transponder antenna and the ground-based radar antenna, the signal may be temporarily interrupted.



---

**NOTE:** Refer to the *TIS-A Limitations* section of the *Aeronautical Information Manual (AIM)* for a more comprehensive explanation of limitations and anomalies associated with TIS-A.

---



---

**NOTE:** TIS-A is unavailable at low altitudes in many areas of the United States. This is often the case in mountainous regions.

---



---

**NOTE:** Garmin is not responsible for Mode S geographical coverage. Operation of the ground stations is the responsibility of the FAA. Refer to the *AIM* for a Terminal Mode S radar site map.

---



TIS-A information is collected during a single radar sweep. Collected information is then sent through the Mode S uplink on the next radar sweep. Because of this, the surveillance information is approximately five seconds old. TIS-A ground station tracking software uses prediction algorithms to compensate for this delay. These algorithms use track history data to calculate expected intruder positions consistent with the time of display. Occasionally, aircraft maneuvering may cause variations in this calculation and create slight errors on the Map Page which affect relative bearing information and the target track vector and may delay display of the intruder information. However, intruder distance and altitude typically remain relatively accurate and may be used to assist in spotting traffic. The following errors are common examples:

- When the client or intruder aircraft maneuvers excessively or abruptly, the tracking algorithm may report incorrect horizontal position until the maneuvering aircraft stabilizes.
- When a rapidly closing intruder is on a course that intercepts the client aircraft course at a shallow angle (either overtaking or head-on) and either aircraft abruptly changes course within 0.25 nm, TIS-A may display the intruder aircraft on the incorrect side of the client aircraft.

These are rare occurrences and are typically resolved within a few radar sweeps once the client/intruder aircraft course stabilizes.

Pilots using TIS-A can provide valuable assistance in the correction of malfunctions by reporting observations of undesirable performance. Reports should identify the time of observation, location, type and identity of the aircraft, and describe the condition observed. Reports should also include the type of transponder and transponder software version. Since TIS-A performance is monitored by maintenance personnel, not ATC, malfunctions should be reported in the following ways:

- By telephone to the nearest Flight Service Station (FSS) facility
- By FAA Form 8000-7, Safety Improvement Report (postage-paid card can be obtained at FAA FSSs, General Aviation District Offices, Flight Standards District Offices, and General Aviation Fixed Base Operators)

- System Overview
- Flight Instruments
- EIS
- CNS Interface
- GPS Navigation
- Flight Planning
- Hazard Avoidance
- Additional Features
- AFCS
- Annun/Alerts
- Appendix**
- Index

Blank Page

# APPENDIX F: ABNORMAL OPERATION

## LOSS OF GPS POSITION

When the G3X Touch loses the GPS signal for any reason, the following will occur:

- A blinking red question mark will appear over the airplane icon on the map.
- Any GPS dependent data fields will not be available.



GPS Signal Lost

## HAZARD DISPLAY WITH LOSS OF GPS POSITION

If the Terrain Page doesn't have at least a 3D fix (i.e. altitude unknown), a Red X will be displayed.



Terrain Page Red X (Split-Screen)

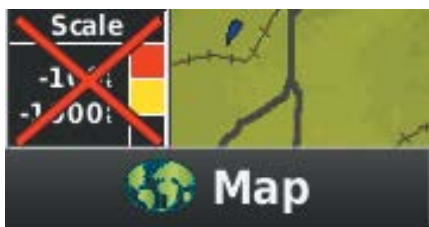

Map Page Red X (Terrain) (Split-Screen)

## G3X TOUCH SYSTEM FAILURE ANNUNCIATIONS

When an LRU or an LRU function fails, a large red 'X' is typically displayed over the instrument(s) or data experiencing the failure. Upon G3X Touch power-up, certain instruments remain invalid as equipment begins to initialize. All instruments should be operational within one minute of power-up. If any instrument remains flagged, the G3X Touch should be serviced.



**NOTE:** Refer to the Pilot's Operating Handbook for additional information regarding pilot responses to these annunciations.



G3X Touch System Failure Annunciations

## UNUSUAL ATTITUDES

The Attitude Indicator includes permanent red warning chevrons to indicate extreme pitch angles. A series of downward-pointing chevrons appear at 50° above the horizon line, and upward-pointing chevrons at 30° below the horizon line.

By default, the PFD will also declutter non-essential information when the G3X Touch detects unusual attitude. The declutter is triggered if the aircraft exceeds 30° nose up, OR 20° nose down, OR 65° of bank in either direction. This can be disabled in the G3X Touch Configuration Mode; refer to the Installation Manual for more information.

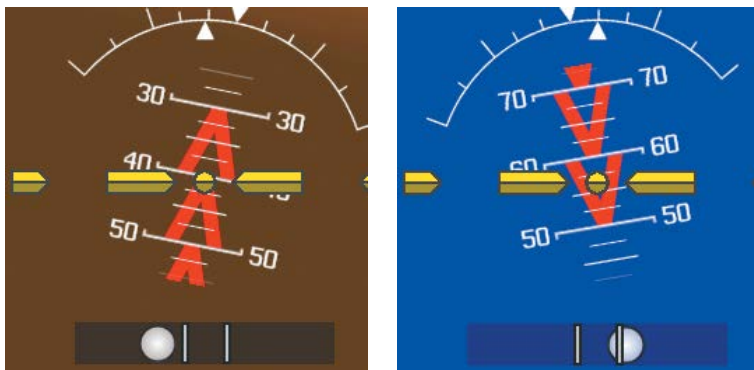

Pitch Attitude Warnings

## REVERSIONARY MODE (FULL-SCREEN)

In the event of a display failure, the G3X Touch System automatically switches to reversionary (backup) mode. In reversionary mode, the information is presented on the remaining display in the split-screen configuration.

If a display failure occurs with the GDU 455/465, the **WX** and **SXM** Pages will no longer be available since the SXM receiver resides in the GDU 455/465.



G3X Touch Full-Screen Reversionary Mode (Failed PFD)

## AFCS REVERSIONARY MODE

In a two display system, in the event of a PFD failure, the MFD goes into reversionary mode, and the autopilot is disengaged. If the MFD fails, the PFD goes into reversionary mode and the autopilot continues to function.

In a GMC 305/307 installation, in the event of display failure(s), basic autopilot functionality remains as long as a ADAHRS unit is still available. The FD is no longer available, but LVL, AP, ALT, and YD are available.

The G3X Touch will revert to showing ADAHRS data from a standby flight display (such as a Garmin G5 Electronic Flight Instrument) if no data is available from a dedicated ADAHRS unit.

## **FAILURE OF THE EXTERNAL GPS NAVIGATION SOURCE**

If the external GPS navigation source fails, the system reverts to the internal GPS navigation source and 'REV' is shown in yellow in the upper left corner of the Data Bar as well as the lower left quadrant of the HSI.

## **SYNTHETIC VISION TROUBLESHOOTING**

Synthetic Vision is intended to be used with traditional attitude, heading, obstacle, terrain, and traffic inputs (in most areas). Synthetic Vision is disabled when valid attitude or heading data is not available for the display. In case of invalid Synthetic Vision data, the PFD display reverts to the standard blue-over-brown attitude display.

Synthetic Vision becomes disabled without the following data resources:











- Attitude data
- Heading data
- GPS position data
- Terrain data
- The position of the aircraft exceeds the range of the terrain database

## **REVERSIONARY MODE WITH SYNTHETIC VISION**







Synthetic Vision can be displayed on the remaining display(s) in Reversionary Mode. If it is enabled when the system switches to Reversionary Mode, Synthetic Vision may take up to 30 seconds to display. The standard display will be shown in the interim.

# APPENDIX G: DISPLAY SYMBOLS

## VFR SYMBOLS









Item	Symbol
Unknown	
Non-towered, Non-serviced	
Towered, Non-serviced	
Non-towered, Serviced	
Towered, Serviced	
Soft Surface, Non-serviced	
Soft Surface, Serviced	
Soft Surface, Private	
Paved, Private	
Seaplane Base	
Heliport	

Americas/Pacific Database Airports

Item	Symbol
Civilian, Non-serviced	
Military, Non-serviced	
Civilian, Serviced	
Military, Serviced	
Civilian, Soft/Unknown Surface, Non-serviced	
Civilian, Soft/Unknown Surface, Serviced	

Atlantic Database Airports

- System Overview
- Flight Instruments
- EIS
- CNS Interface
- GPS Navigation
- Flight Planning
- Hazard Avoidance
- Additional Features
- AFCs
- Annun/Alerts
- Appendix
- Index



Item	Symbol
Intersection	
Visual Reporting Point	
LOM (compass locator at outer marker)	
NDB (non-directional radio beacon)	
VOR	
VOR/DME	
ILS/DME or DME only	
VORTAC	
TACAN	

Nav aids



Item	Symbol
Interstate Highway	
US Highway	
State Highway	
National Highway	
Small City	
Medium City	
Large City	

Miscellaneous

## IFR SYMBOLS

Item	Symbol
VFR, Soft/unknown Surface, Non-serviced	
VFR, Soft/unknown Surface, Serviced	

Atlantic Database Airports

Item	Symbol
Low-Altitude	
High-Altitude	

Airways



Item	Symbol
Unknown	
VFR Airport, Non-serviced	
IFR Airport, Non-serviced	
VFR Airport, Serviced	
IFR Airport, Serviced	
VFR, Soft Surface, Non-serviced	
VFR, Soft Surface, Serviced	
VFR, Soft Surface, Private	
VFR, Paved, Private	
VFR Seaplane Base	
VFR Heliport	

### Americas/Pacific Database Airports

Item	Symbol
Intersection	
LOM (compass locator at outer marker)	
NDB (non-directional radio beacon)	
VOR	
VOR/DME	
ILS/DME or DME Only	
VORTAC	
TACAN	

### Nav aids

# AIRSPACE SYMBOLS



- System Overview
- Flight Instruments
- EIS
- CNS Interface
- GPS Navigation
- Flight Planning
- Hazard Avoidance
- Additional Features
- AFCs
- Annun/Alerts
- Appendix
- Index

Item	Symbol
Class B, Class E, CTA	
Class A, Class C, TMA	
Class D	
Mode C Veil	
TRSA	
MOA	
Danger, Alert, or Training Area	
Restricted, Prohibited, or Warning Area	
Radar Area	
ATZ, TIZ	
MATZ	
ADIZ	
Misc/Unknown	

VFR Americas/Pacific Database

Item	Symbol
Class B, Class E, CTA	
Class A, Class C, TMA, TRSA	
Class D	
MOA	
Danger, Alert, or Training Area	
Restricted, Prohibited, or Warning Area	
Radar Area	
ATZ, TIZ	
Misc/Unknown	

IFR Americas/Pacific Database

Item	Symbol
Danger or Alert Area	
Restricted, Prohibited, or Warning Area	
Training Area	

**VFR Atlantic Database Exceptions**

Item	Symbol
Training Area	

**IFR Atlantic Database Exceptions**

- System Overview
- Flight Instruments
- EIS
- CNS Interface
- GPS Navigation
- Flight Planning
- Hazard Avoidance
- Additional Features
- AFCS
- Annun/Alerts
- Appendix**
- Index

Blank Page

## APPENDIX H: GLOSSARY

ADIZ	Air Defense Identification Zone
ADS-B	Automatic Dependant Surveillance-Broadcast
ADS-B In	Ability to receive ADS-B information from other aircraft and Ground Based Transceivers (GBTs)
ADS-B Out	Ability to transmit ADS-B data on 1090 ES or 978 MHz
ADS-B Participating Aircraft	An aircraft that has both ADS-B In and ADS-B Out capabilities.
ADS-R	Automatic Dependent Surveillance-Rebroadcast
AGL	Above Ground Level
AIM	Airman's Information Manual
AIRMET	Airman's Meteorological Information
AOA	Angle of Attack
AP	Autopilot
APT	airport
ASPC	airspace
ARTCC	Air Route Traffic Control Center
ASOS	Automated Surface Observing System
ATC	Air Traffic Control
ATIS	Automatic Terminal Information Service
AWOS	Automated Weather Observing System
Bearing	The compass direction from the present position to a destination waypoint.
°C	degrees Celsius
Calibrated Airspeed	Indicated airspeed corrected for installation and instrument errors.
cm	centimeter

System Overview	COM	communication radio
Flight Instruments	Course	The line between two points to be followed by the aircraft.
EIS	Course to Steer	The recommended direction to steer in order to reduce course error or stay on course. Provides the most efficient heading to get back to the desired course and proceed along the flight plan.
CNS Interface	Crosstrack Error	The distance the aircraft is off a desired course in either direction, left or right.
GPS Navigation	CTS	Course to Steer
Flight Planning	dBZ	decibels 'Z' (radar return)
Hazard Avoidance	deg	degree
Additional Features	Desired Track	The desired course between the active "from" and "to" waypoints.
AFCS	DIS	distance
Annun/Alerts	Distance	The 'great circle' distance from the present position to a destination waypoint.
Index	DME	Distance Measuring Equipment
	DTK	Desired Track
	Enroute Safe Altitude	The recommended minimum altitude within ten miles left or right of the desired course on an active flight plan or direct-to.
	ENT	enter
	ESA	Enroute Safe Altitude
	Estimated Time of Arrival	The estimated time at which the aircraft should reach the destination waypoint, based upon current speed and track.
	Estimated Time Enroute	The estimated time it takes to reach the destination waypoint from the present position, based upon current ground speed.
	ETA	Estimated Time of Arrival
	ETE	Estimated Time Enroute

°F	degrees Fahrenheit	System Overview
FAA	Federal Aviation Administration	Flight Instruments
FAF	Final Approach Fix	
FCC	Federal Communication Commission	EIS
FPL	flight plan	
fpm	feet per minute	CNS Interface
FSS	Flight Service Station	
ft	foot/feet	GPS Navigation
gal	gallon(s)	
geodetic altitude	GPS calculated altitude	Flight Planning
Glide Ratio, G/R	The ratio of horizontal distance (distance traveled over the ground) to vertical distance traveled (nn.n:1).	
GND	ground	Hazard Avoidance
gph	gallons per hour	
GPS	Global Positioning System	Additional Features
Grid MORA	Grid Minimum Off-Route Altitude; one degree latitude by one degree longitude in size and clears the highest elevation reference point in the grid by 1000 feet for all areas of the grid	
Groundspeed	The velocity that the aircraft is travelling relative to a ground position.	AFCS
Ground-Based Transceiver	Provides ADS-R, TIS-B and FIS-B broadcasts to ADS-B participating aircraft.	
Ground Track	see Track	Annun/Alerts
GS	Ground speed	
Heading	The direction an aircraft is pointed, based upon indications from a magnetic compass or a properly set directional gyro.	Appendix
Hg	mercury	Index
hPa	hectopascal	
hr	hour	

System Overview	HSI	Horizontal Situation Indicator
	Hz	Hertz
	IAF	Initial Approach Fix
Flight Instruments	IAT	Indicated Air Temperature
	ICAO	International Civil Aviation Organization
	IFR	Instrument Flight Rules
EIS	ILS	Instrument Landing System
	IMC	Instrument Meteorological Conditions
CNS Interface	in	inch
	Indicated	Information provided by properly calibrated and set instrumentation on the aircraft panel.
GPS Navigation	in HG	inches of mercury
	kg	kilogram
Flight Planning	kHz	kilohertz
	km	kilometer
Hazard Avoidance	kt	knot
	LAT	latitude
Additional Features	lb	pound
	Leg	The portion of a flight plan between two waypoints.
AFCs	LON	longitude
	m	meter
Annun/Alerts	MAP	Missed Approach Point
	METAR	Meteorological Aviation Routine
Appendix	MHz	megahertz
	Minimum Safe Altitude	Uses Grid MORAs to determine a safe altitude within ten miles of the aircraft present position.
Index	MOA	Military Operations Area



MSA	Minimum Safe Altitude
MSL	Mean Sea Level
NAVAID	NAVigation AID
NDB	Non-directional Beacon
NEXRAD	Next Generation Radar
nm	nautical mile(s)
NRST	nearest
OAT	Outside Air Temperature
OBS	Omni Bearing Selector
psi	pounds per square inch
QTY	quantity
rpm	revolutions per minute
SBAS	Satellite-Based Augmentation System
SD	Secure Digital
sec	second(s)
SIGMET	Significant Meteorological Information
TACAN	Tactical Air Navigation System
TAF	Terminal Aerodrome Forecast
TAS	True Airspeed
TER	terrain
TFR	Temporary Flight Restriction
TOPO	topographic
TIS-A	Traffic Information Service

System  
Overview

Flight  
Instruments

EIS

CNS  
Interface

GPS  
Navigation

Flight  
Planning

Hazard  
Avoidance

Additional  
Features

AFCs

Annun/Alerts

Appendix

Index

System Overview	TIS-B	Traffic Information Service-Broadcast
Flight Instruments	Track	Direction of aircraft movement relative to a ground position; also 'Ground Track'
EIS	TRSA	Terminal Radar Service Area
CNS Interface	UTC	Coordinated Universal Time
GPS Navigation	VFR	Visual Flight Rules
Flight Planning	VHF	Very High Frequency
Hazard Avoidance	VNAV	vertical navigation
Additional Features	VOL	volume
AFCS	VOR	VHF Omni-directional Range
Annun/Alerts	VORTAC	very high frequency omnidirectional range station and tactical air navigation
Appendix	VSI	Vertical Speed Indicator
Index	VSR	Vertical Speed Required
	VTF	vector to final
	WAAS	Wide Area Augmentation System
	WPT	waypoint
	WX	weather

# APPENDIX I: LICENSE AGREEMENT AND WARRANTY

## CONTACT GARMIN

Contact Garmin if you have any questions while using your G3X Touch. In the USA contact Garmin Product Support by phone: (913) 397-8200 or (800) 800-1020, Monday–Friday, 8 AM–5 PM Central Time; or go to [www.garmin.com/support](http://www.garmin.com/support).

In Europe, contact Garmin (Europe) Ltd. at +44 (0) 870.8501241 (outside the UK) or 0808 2380000 (within the UK).

## SOFTWARE LICENSE AGREEMENT

BY USING THE G3X Touch, YOU AGREE TO BE BOUND BY THE TERMS AND CONDITIONS OF THE FOLLOWING SOFTWARE LICENSE AGREEMENT. PLEASE READ THIS AGREEMENT CAREFULLY.

Garmin grants you a limited license to use the software embedded in this device (the “Software”) in binary executable form in the normal operation of the product. Title, ownership rights, and intellectual property rights in and to the Software remain with Garmin.

You acknowledge that the Software is the property of Garmin and is protected under the United States of America copyright laws and international copyright treaties. You further acknowledge that the structure, organization, and code of the Software are valuable trade secrets of Garmin and that the Software in source code form remains a valuable trade secret of Garmin. You agree not to decompile, disassemble, modify, reverse assemble, reverse engineer, or reduce to human readable form the Software or any part thereof or create any derivative works based on the Software. You agree not to export or re-export the Software to any country in violation of the export control laws of the United States of America.

## LIMITED WARRANTY FOR G3X TOUCH PRODUCTS

Garmin G3X Touch LRUs GAD 29, GAP 26, GDU 37X, GDU 45X/46X, GEA 24, GI 260, GMC 305, GMC 307, GMU 22, GMU 44, GPS 20A, GSA 28, GSU 25/25B, GSU 73, GTP 59, & GTR 20 are warranted to be free from defects in materials or workmanship for two years from the date of purchase. Within the applicable period, Garmin will, at its sole option, repair or replace any components that fail in normal use. Such repairs or replacement will be made at no charge to the customer for parts or labor, provided that the customer shall be responsible for any transportation cost. This warranty does not apply to: (i) cosmetic damage, such as scratches, nicks and dents; (ii) consumable parts, such as batteries, unless product damage has occurred due to a defect in materials or workmanship; (iii) damage caused by accident, abuse, misuse, water, flood, fire, or other acts of nature or external causes; (iv) damage caused by service performed by anyone who is not an authorized service provider of Garmin; or (v) damage to a product that has been modified or altered without the written permission of Garmin. In addition, Garmin reserves the right to refuse warranty claims against products or services that are obtained and/or used in contravention of the laws of any country.

THE WARRANTIES AND REMEDIES CONTAINED HEREIN ARE EXCLUSIVE AND IN LIEU OF ALL OTHER WARRANTIES, WHETHER EXPRESS, IMPLIED OR STATUTORY, INCLUDING ANY LIABILITY ARISING UNDER ANY WARRANTY OF MERCHANTABILITY OR FITNESS FOR A PARTICULAR PURPOSE, STATUTORY OR OTHERWISE. THIS WARRANTY GIVES YOU SPECIFIC LEGAL RIGHTS, WHICH MAY VARY FROM STATE TO STATE.

IN NO EVENT SHALL GARMIN BE LIABLE FOR ANY INCIDENTAL, SPECIAL, INDIRECT OR CONSEQUENTIAL DAMAGES, WHETHER RESULTING FROM THE USE, MISUSE OR INABILITY TO USE THE PRODUCT OR FROM DEFECTS IN THE PRODUCT. SOME STATES DO NOT ALLOW THE EXCLUSION OF INCIDENTAL OR CONSEQUENTIAL DAMAGES, SO THE ABOVE LIMITATIONS MAY NOT APPLY TO YOU.

Garmin retains the exclusive right to repair or replace (with a new or newly-overhauled replacement product) the product or software or offer a full refund of the purchase price at its sole discretion. SUCH REMEDY SHALL BE YOUR SOLE AND EXCLUSIVE REMEDY FOR ANY BREACH OF WARRANTY.

**Online Auction Purchases:** Products purchased through online auctions are not eligible for warranty coverage.

Online auction confirmations are not accepted for warranty verification. To obtain warranty service, an original or copy of the sales receipt from the original retailer is required. Garmin will not replace missing components from any package purchased through an online auction.

**International Purchases:** A separate warranty may be provided by international distributors for devices purchased outside the United States depending on the country. If applicable, this warranty is provided by the local in-country distributor and this distributor provides local service for your device. Distributor warranties are only valid in the area of intended distribution. Devices purchased in the United States or Canada must be returned to the Garmin service center in the United Kingdom, the United States, Canada, or Taiwan for service.

Garmin International, Inc.  
1200 East 151st Street  
Olathe, Kansas 66062, U.S.A.  
Phone: 913 397 8200  
Fax: 913 397 8282

Garmin (Europe) Ltd.  
Liberty House, Hounsdown Business Park  
Southampton, Hampshire SO40 9LR, U.K.  
Phone: +44 (0) 238 052 4000  
Fax: +44 (0) 238 052 4004  
Aviation Support: +44 (0) 370 850 1243

Refer to the G3X Installation Manual for warranty registration instructions.

## AOPA AIRPORT DIRECTORY NOTICE

AOPA MEMBERSHIP PUBLICATIONS, INC. AND ITS RELATED ORGANIZATIONS (HEREINAFTER COLLECTIVELY "AOPA") EXPRESSLY DISCLAIM ALL WARRANTIES, WITH RESPECT TO THE AOPA INFORMATION INCLUDED IN THIS DATA, EXPRESS OR IMPLIED, INCLUDING, BUT NOT LIMITED TO, THE IMPLIED WARRANTIES OF MERCHANTABILITY AND FITNESS FOR A PARTICULAR PURPOSE. THE INFORMATION IS PROVIDED "AS IS" AND AOPA DOES NOT WARRANT OR MAKE ANY REPRESENTATIONS REGARDING ITS ACCURACY, RELIABILITY, OR OTHERWISE. UNDER NO CIRCUMSTANCES INCLUDING NEGLIGENCE, SHALL AOPA BE LIABLE FOR ANY INCIDENTAL, SPECIAL OR CONSEQUENTIAL DAMAGES THAT RESULT FROM THE USE OR INABILITY TO USE THE SOFTWARE OR RELATED DOCUMENTATION, EVEN IF AOPA OR AN AOPA AUTHORIZED REPRESENTATIVE HAS BEEN ADVISED OF THE POSSIBILITY OF SUCH DAMAGES. USER AGREES NOT TO SUE AOPA AND, TO THE MAXIMUM EXTENT ALLOWED BY LAW, TO RELEASE AND HOLD HARMLESS AOPA FROM ANY CAUSES OF ACTION, CLAIMS OR LOSSES RELATED TO ANY ACTUAL OR ALLEGED INACCURACIES IN THE INFORMATION ARISING OUT OF GARMIN'S USE OF THE INFORMATION IN THE DATASETS. SOME JURISDICTIONS DO NOT ALLOW THE LIMITATION OR EXCLUSION OF IMPLIED WARRANTIES OR LIABILITY FOR INCIDENTAL OR CONSEQUENTIAL DAMAGES SO THE ABOVE LIMITATIONS OR EXCLUSIONS MAY NOT APPLY TO YOU.

## AC-U-KWIK LICENSE AGREEMENT

AC-U-KWIK AND ITS RELATED ORGANIZATIONS (HEREINAFTER COLLECTIVELY "AC-U-KWIK ORGANIZATIONS") EXPRESSLY DISCLAIM ALL WARRANTIES WITH RESPECT TO THE AC-U-KWIK INFORMATION INCLUDED IN THIS DATA, EXPRESS OR IMPLIED, INCLUDING, BUT NOT LIMITED TO, THE IMPLIED WARRANTIES OF MERCHANTABILITY AND FITNESS FOR A PARTICULAR PURPOSE. THE INFORMATION IS PROVIDED "AS IS" AND AC-U-KWIK ORGANIZATIONS DO NOT WARRANT OR MAKE ANY REPRESENTATIONS REGARDING ITS ACCURACY, RELIABILITY, OR OTHERWISE. LICENSEE AGREES NOT TO SUE AC-U-KWIK ORGANIZATIONS AND, TO THE MAXIMUM EXTENT ALLOWED BY LAW, TO RELEASE AND HOLD HARMLESS AC-U-KWIK ORGANIZATIONS FROM ANY CAUSES OF ACTION, CLAIMS OR LOSSES RELATED TO ANY ACTUAL OR ALLEGED INACCURACIES IN THE INFORMATION ARISING OUT OF GARMIN'S USE OF THE INFORMATION IN THE DATASETS. SOME JURISDICTIONS DO NOT ALLOW THE LIMITATION OR EXCLUSION OF IMPLIED WARRANTIES OR LIABILITY FOR INCIDENTAL OR CONSEQUENTIAL DAMAGES SO THE ABOVE LIMITATIONS OR EXCLUSIONS MAY NOT APPLY TO LICENSEE.

## SIRIUSXM SATELLITE RADIO SERVICE AGREEMENT

Hardware and required monthly subscription sold separately. USER ACKNOWLEDGES THAT GARMIN HAS NO CONTROL OVER THE TERMS AND REQUIREMENTS OF THE SUBSCRIPTION. COMPATABILITY OF HARDWARE EQUIPMENT WITH THEN-CURRENT SUBSCRIPTION OFFERING OF SERVICE PROVIDER IS ALSO BEYOND GARMIN'S CONTROL. GARMIN SHALL HAVE NO LIABILITY IF CHANGES IN SERVICE PROVIDER'S SUBSCRIPTION OFFERING NEGATIVELY IMPACTS OR RENDERS IMPOSSIBLE THE USE OF PURCHASED GARMIN HARDWARE EQUIPMENT WITH THE SERVICE PROVIDER'S OFFERING IN THE FUTURE. Subscription fee is consumer only. Other fees and taxes, including a one-time activation fee may apply. All programming fees and weather data subject to change. Sirius XM weather data and individual product availability vary by hardware equipment. Reception of the Sirius XM signal may vary depending on location. Subscriptions subject to Customer Agreement included with the Sirius XM Welcome Kit and available at [www.siriusxm.com](http://www.siriusxm.com). USER ACKNOWLEDGES THAT GARMIN IS AN INTENDED THIRD PARTY BENEFICIARY OF SUCH CUSTOMER AGREEMENT, AND THAT ALL DISCLAIMERS CONTAINED THEREIN EQUALLY APPLY AS IF SUCH DISCLAIMERS WERE MADE DIRECTLY BY GARMIN. Available only in the 48 contiguous United States.

THE USER AGREES THAT THE SIRIUS XM WEATHER SERVICE OFFERING IS PROVIDED "AS IS", THAT YOUR GARMIN HARDWARE EQUIPMENT ONLY ALLOWS THE DISPLAY OF SUCH SERVICE OFFERING, AND THAT ANY CHANGES BY THE SERVICE PROVIDER MAY INTERFERE WITH THE ABILITY OF YOUR GARMIN HARDWARE EQUIPMENT TO RECEIVE OR DISPLAY SUCH SERVICE OFFERING. FURTHER, SUCH SERVICE OFFERING CONTAINS INFORMATION FURNISHED BY OTHERS WHO ARE NOT UNDER THE CONTROL OF GARMIN, AND THEREFORE THE SERVICE OFFERING IS ACCORDINGLY FURNISHED WITHOUT ANY WARRANTY OF GARMIN, EXPRESS OR IMPLIED, INCLUDING WITHOUT LIMITATION, IMPLIED WARRANTIES OF MERCHANTABILITY AND FITNESS FOR A PARTICULAR PURPOSE.

Contact SiriusXM Satellite Radio by phone at 800.985.9200 to subscribe to XM WX Weather and/or SiriusXM Radio.

## WEATHER DATA WARRANTY

THE WEATHER DATA SOFTWARE PRODUCT IS PROVIDED "AS IS." ALL OTHER WARRANTIES, EXPRESSED OR IMPLIED, INCLUDING ANY WARRANTY OF MERCHANTABILITY OR FITNESS FOR A PARTICULAR PURPOSE OR OF NON-INFRINGEMENT ARE HEREBY EXCLUDED.

## USER SAFETY

If you use XM Services it is your responsibility to exercise prudent discretion and observe all safety measures required by law and your own common sense. You assume the entire risk related to your use of the Services. XM and Garmin assume no responsibility for accidents resulting from or associated with use of the Services. Your Radio Service includes traffic and weather information, and you acknowledge that such information is not for “safety for life”, but is merely supplemental and advisory in nature, and therefore cannot be relied upon as safety-critical in connection with any aircraft, sea craft or automobile usage. This information is provided “as is” and XM and Garmin disclaim any and all warranties, express and implied, with respect thereto or the transmission or reception thereof. XM and Garmin further do not warrant the accuracy, reliability, completeness or timeliness of the traffic and weather information disclosed on the Radio Service. In no event will XM and Garmin, their data suppliers, service providers, marketing/distribution, software or Internet partners or hardware manufacturers be liable to you or to any third party for any direct, indirect, incidental, consequential, special, exemplary or punitive damages or lost profits resulting from use of or interruptions in the transmission or reception of the Services.

## LIMITS ON OUR RESPONSIBILITY

## a) DISCLAIMERS.

EXCEPT AS EXPRESSLY PROVIDED HEREIN, WE MAKE NO WARRANTY OR REPRESENTATION, EITHER EXPRESS OR IMPLIED, REGARDING THE RADIO SERVICE. YOUR USE OF THE SERVICE IS AT YOUR SOLE RISK. THE CONTENT AND FUNCTIONALITY OF THE SERVICE IS PROVIDED “AS IS” WITHOUT ANY WARRANTY OF ANY KIND, EXPRESS OR IMPLIED. ALL SUCH WARRANTIES OR REPRESENTATIONS (INCLUDING, WITHOUT LIMITATION, THE IMPLIED WARRANTIES OF MERCHANTABILITY, FITNESS FOR A PARTICULAR PURPOSE, TITLE AND NON-INFRINGEMENT) ARE HEREBY DISCLAIMED.

## b) LIMITATIONS OF LIABILITY.

WE ARE NOT RESPONSIBLE FOR ANY SPECIAL, INCIDENTAL, OR CONSEQUENTIAL DAMAGES OR LOSSES RELATING TO THE USE OF THE RADIO SERVICE, WHETHER BASED ON NEGLIGENCE OR OTHERWISE. OUR TOTAL LIABILITY TO YOU AND ANY OTHER PERSONS RECEIVING OUR SERVICES, REGARDLESS OF THE CAUSE, WILL IN NO EVENT EXCEED THE AMOUNTS THAT YOU HAVE PAID TO US FOR THE SERVICE THAT YOU RECEIVED DURING THE SIX (6) MONTH PERIOD IMMEDIATELY PRIOR TO THE SPECIFIC EVENT THAT GAVE RISE TO THE APPLICABLE DAMAGE OR LOSS. THIS ALLOCATION OF RISK IS REFLECTED IN OUR PRICES. YOU MAY HAVE GREATER RIGHTS THAN DESCRIBED ABOVE UNDER YOUR STATE’S LAWS

This product was developed using DAFIF™, a product of the National Geospatial-Intelligence Agency.

This product has not been endorsed or otherwise approved by the National Geospatial-Intelligence Agency, or the United States Department of Defense (10 U.S.C. 425)

- a. Under 10 U.S.C. 456, no civil action may be brought against the United States on the basis of the content of a navigational aid prepared or disseminated by either the former Defense Mapping Agency (DMA), National Imagery and Mapping Agency (NIMA), or the National Geospatial-Intelligence Agency (NGA).
- b. The DAFIF™ product is provided “as is,” and no warranty, express or implied, including, but not limited to the implied warranties of merchantability and fitness for particular purpose or arising by statute or otherwise in law or from a course of dealing or usage in trade, is made by NGA as to the accuracy and functioning of the product.
- c. Neither NGA nor its personnel will be liable for any claims, losses, or damages arising from or connected with the use of this product. The user agrees to hold harmless the United States National Geospatial-Intelligence Agency. The user’s sole and exclusive remedy is to stop using the DAFIF product.

**A**

- Acquiring Satellites 28
- Active frequency 92
- ADS-B 217
- ADS-B In 209
- ADS-B Out 209
- ADS-B participating 209
- ADS-R 209
- Air Data Computer (ADC) 3, 4
- AIRMET 182
- Airport
  - Criteria 40
  - Nearest 139
  - Review 137
  - Weather 140
- Airspace 123, 144
  - Alerts 145
  - Selecting and Viewing 144
  - Smart 145
- Airspeed Indicator 45
- Airways 134
  - Reviewing 135
- Alarms 39
- Alerts 323
- Altimeter 50–53
- Altitude Alerting 53
- Altitude Hold Mode (ALT) 297
- Altitude Reference 296
- AOPA 243
- Approach 162
  - Activating Vectors-to-Final 165
  - Chart 163
  - Loading 163
  - Removing 164
  - Selecting 163

- Approach Mode 315
- Attitude and Heading Reference System (AHRS) 3, 4, 21
- Attitude Indicator 48
- Automatic Dependent Surveillance-Broadcast 208
- Automatic Dependent Surveillance-Rebroadcast 209
- Automatic Reversion 302
- Automatic squelch 94
- Autopilot Disconnect 281
- Auto-Slewing 65

**B**

- Barometric setting, Altimeter 45, 51–52
- Basemap 359
- Bearing/Distance, Measuring 126, 127, 129, 131
- Bearing Pointers 59
- Bearing source 60

**C**

- CDI source 59
- Chart Not Available 238, 241
- COM frequency box 92
- Command Bars 292
- Comparator Window 332
- Compass Arc 119
- Control Wheel Steering (CWS) 272
- Course Deviation Indicator (CDI) 59
- Crew Alerting System (CAS) 81, 86, 87, 331
- Current Icing Product (CIP) 185

**D**

Data Bar Fields 31, 335

Databases 359

Updating 362

Data Entry 23–24

Date & Time 37

Delete

Flight Plans 158, 160

Flight Records 345

Individual Waypoint 160

Direct-to 146

Canceling 148

Display

Backlighting 30

Overview 12

Symbols 377

## E

Echo Tops 178

Engine/Airframe Unit 3

Engine Indication System (EIS) 77

Engine Manifold Pressure 79

ENG Page 77

Exhaust Gas Temperature 79

## F

Field of View 234

FIS-B 209

Flight director (FD) 274

Modes, vertical 293–307

Flight Information Service-Broadcast  
209

Flight Instruments 43

Flight Level Change Mode 299

Flight Log 343

Flight Plan 151

Activation 156

Active 153

Adding Waypoints 157

Approaches 162

Copying 159

Creation 153

Data Fields 152

Editing 157

Fuel Flow 158

Inverting 161

Name 158

Speed 158

Waypoints, Adding 157

Flight Plan (FPL) Pages 25

FliteCharts 239

Expiration 242

Range 238, 242

FMS Joystick 13

Forecast 186

Freezing Levels 184

Frequencies 90

Fuel Calculator 86

Fuel Flow Indicator 79

Fuel Pressure Indicator 79

Fuel Quantity Indicator 79

Fuel Range Ring 126, 127, 129, 131

## G

Garmin Display Unit (GDU) 40

Garmin Sensor Unit (GSU) 3, 4

GBT 209

GDL 39 169, 170, 193, 194, 208, 210,  
217

GDU 370 2

Glidepath Mode (GP) 303

Glideslope Mode 305

GMU 44 5

GPS Receiver Status 27

Ground Based Transceivers 209

GSU 73 3

GTP 59 4, 5, 6, 7



**H**

- Hazard Display 373
- Heading 45
- Heading Line 350
- Heading Select Mode 309
- Heading Strip 66
- Horizontal Situation Indicator (HSI) 45, 57
  - Annunciations 59

**I**

- Icing Forecast 185
- Information Window 59
- Integrated Autopilot
  - Alerts 333
  - Disengaging 283
  - Engaging 282
- Intersections 140
- Inverting, Flight Plan 161

**L**

- Lean Assist 81
- Legends 173
- License Agreement 389
- Limited Warranty 389
- Line Replaceable Unit (LRU) 1
- Location Formats 39, 367

**M**

- Magnetometer 5
- Main Pages 25
- Map
  - Airways 135
  - Customizing 122
  - Detail 133
  - Displays 120
  - Orientation 121

- Panning 125
- Range 123
- Satellite View 133
- Setup 121
- Symbols 133, 377
- Map Datum 367
- MAP Page
  - Defaults 173
  - XM Weather 172
- Map Range 123
- Map Symbols 133
- Measuring
  - Bearing 132
  - Distance 132
- MENU Key 13
- Menus 23
  - Navigating 286, 289
- Messages
  - Miscellaneous 323, 324
  - System 325
- METAR 181
  - Flag Color 181

**N**

- Navigation Mode 310–311
- Navigation Source 10, 62
- NDBs 141
- Nearest
  - Airport 139
  - Airspaces 144, 145
  - NDB 141
  - VORs 141
- Nearest Information 139
- Nearest Type
  - Changing 29
- New Location 28
- NEXRAD 175, 177
- NRST Key 13

- O**
- OBS Mode 67
  - Obstacles 189
  - Oil Pressure Indicator 79
  - Oil Temperature Indicator 79
  - Outside Air Temperature (OAT) 69, 80
- P**
- Pages 24
    - Flight Plan (FPL) 25
    - MAIN 25
  - Panning 125
  - PFD
    - Annunciations 331
  - PIREP 184
  - Pitch Hold Mode 295
  - Position 29
    - Settings 39
  - Power-up 14
  - Proximity Waypoints 354
- R**
- Red X 21, 373
  - Reversionary Sensor Window 22
  - Roll Hold Mode 308
  - Runway Extension line 122
  - Runway Number 122
- S**
- SafeTaxi 222, 236
  - Satellite Information 28
  - Satellite Mosaic 178
  - Satellite View 133
  - Secure Digital (SD) Cards 14, 357
    - Installing 14
  - Selected Altitude 295, 296, 298
  - Selected Altitude Capture Mode 295, 296, 298, 306
  - Selected Heading 57, 309
  - Settings 30
  - SIGMET 182
  - SiriusXM 168, 169, 171, 172, 221, 245, 391
  - Smart Airspace 145
  - Sound 37
  - Standby frequency 92
  - Storm Cells 181
  - Supercooled Large Droplet (SLD) 185
  - Surface Pressure 180
  - Symbols 133
  - Synthetic Vision (SVX) 221
  - System
    - Annunciations 21
    - Date & Time 38
    - Functionality 23
    - Initialization 14
    - Power-up 14
    - Settings 30
    - System ID 362
- T**
- Tachometer (RPM) 79
  - TAFs 181
  - Takeoff Mode 306
  - TAS 369
  - TCAS 369
  - Temperature Probe 5
  - Temporary Flight Restrictions (TFRS) 183
  - Terrain 186
    - Alerts 190, 191
    - Annunciations 331
    - Obstacle Information 189
    - Shading 188
    - Views 188

TIS-B 209  
 Topography 132  
 Track Log 346  
 Traffic Information Service-Broadcast  
     209  
 Traffic Information Service (TIS) 193,  
     369–370  
     Annunciations 196, 331  
     Audio Alerts 197  
     General Information 369  
     Ground Track 198  
     Limitations 370  
 traffic warning window 214  
 Traffic Warning Window 197, 198  
 Transponder  
     Status Box 45  
 True Airspeed (TAS) 45  
 Turbulence Forecast 185  
 Turn Rate Indicator 45

## U

UAT 209  
 Universal Access Transceiver 208  
 User Waypoints 142  
     Creating 142, 143  
     Deleting 143  
     Editing 143  
     Nearest 143  
     Renaming 143

## V

Vertical Deviation Indicator (VDI) 55  
 Vertical Navigation (VNAV) 73  
     Capturing 76  
     Configuring 75  
 Vertical Power 25, 247, 334  
 Vertical Speed Indicator (VSI) 54  
 Vertical Speed Mode 298

Vertical Speed Reference 298  
 VNAV Target Altitude Capture Mode  
     (ALTV) 302  
 Voltmeter 79  
 VORs 141  
 VP-X 25, 247  
 Vspeed Reference 40

## W

Warranty 389  
 Waypoints 136, 142  
     Creating 142, 143  
     User 142  
 Weather Information 140  
 Weight & Balance 352  
 Wind Data 69  
 Winds Aloft 179

## X

XM  
     Accessing 172  
     XM Satellite Radio 245, 249  
 X Symbol 188

System Overview

Flight Instruments

EIS

CNS Interface

GPS Navigation

Flight Planning

Hazard Avoidance

Additional Features

AFCs

Annun/Alerts

Appendix

Index

Blank Page





Garmin International, Inc.  
1200 East 151st Street  
Olathe, Kansas 66062, U.S.A.  
Tel: 913.397.8200  
Fax: 913.397.8282

Aircraft On Ground (AOG) Hotline: 913.397.0836  
Aviation Dealer Technical Support: 888.606.5482

Garmin AT, Inc.  
2345 Turner Road SE  
Salem, OR 97302, U.S.A.  
Tel: 503.581.8101  
Fax 503.364.2138

Garmin (Europe) Ltd.  
Liberty House, Hounsdown Business Park  
Southampton, Hampshire SO40 9LR U.K.  
Tel: +44 (0) 238 052 4000  
Fax: +44 (0) 238 052 4004  
Aviation Support: +44 (0) 370 850 1243

Garmin Corporation  
No. 68, Zhangshu 2nd Road  
Xizhi District, New Taipei City, Taiwan  
Tel: 34-93-357-2608  
Fax: 34-93-429-4484

[www.garmin.com](http://www.garmin.com)

